

Newton 's Law of Cooling by Prof. Subhashish Chattopadhyay SKMClasses Bangalore Useful for IIT-JEE, CBSE, I.Sc. PU-II, Boards, CET, CEE, PET, IGCSE IB AP-Physics and other exams



Spoon Feeding - Newton 's Law of Cooling



Simplified Knowledge Management Classes Bangalore

My name is [Subhashish Chattopadhyay](#). I have been teaching for IIT-JEE, Various International Exams (such as IMO [International Mathematics Olympiad], IPhO [International Physics Olympiad], IChO [International Chemistry Olympiad]), IGCSE (IB), CBSE, I.Sc, Indian State Board exams such as WB-Board, Karnataka PU-II etc since 1989. As I write this book in 2016, it is my 27 th year of teaching. I was a Visiting Professor to BARC Mankhurd, Chembur, Mumbai, Homi Bhabha Centre for Science Education (HBCSE) Physics Olympics camp BARC Campus.

Newton 's Law of Cooling by Prof. Subhashish Chattopadhyay SKMClasses Bangalore Useful for IIT-JEE, CBSE, I.Sc. PU-II, Boards, CET, CEE, PET, IGCSE IB AP-Physics and other exams

Newton 's Law of Cooling by Prof. Subhashish Chattopadhyay SKMClasses Bangalore Useful for IIT-JEE, CBSE, I.Sc. PU-II, Boards, CET, CEE, PET, IGCSE IB AP-Physics and other exams

I am Life Member of ...

- [IAPT \(Indian Association of Physics Teachers \)](#)
- [IPA \(Indian Physics Association \)](#)
- [AMTI \(Association of Mathematics Teachers of India \)](#)
- [National Human Rights Association](#)
- [Men's Rights Movement \(India and International \)](#)
- [MGTOW Movement \(India and International \)](#)

And also of

[IACT \(Indian Association of Chemistry Teachers \)](#)



The selection for National Camp (for Official Science Olympiads - Physics, Chemistry, Biology, Astronomy) happens in the following steps

1) **NSEP** (National Standard Exam in Physics) and **NSEC** (National Standard Exam in Chemistry) held around 24 rth November. Approx 35,000 students appear for these exams every year. The exam fees is Rs 100 each. Since 1998 the IIT JEE toppers have been topping these exams and they get to know their rank / performance ahead of others.

2) **INPhO** (Indian National Physics Olympiad) and **INChO** (Indian National Chemistry Olympiad). Around 300 students in each subject are allowed to take these exams. Students coming from outside cities are paid fair from the Govt of India.

3) The Top 35 students of each subject are invited at HBCSE (Homi Bhabha Center for Science Education) Mankhurd, near Chembur, BARC, Mumbai. After a 2-3 weeks camp the top 5 are selected to represent India. The flight tickets and many other expenses are taken care by Govt of India.

Since last 50 years there has been no dearth of "Good Books". Those who are interested in studies have been always doing well. This e-Book does not intend to replace any standard text book. These topics are very old and already standardized.

Newton 's Law of Cooling by Prof. Subhashish Chattopadhyay SKMClasses Bangalore Useful for IIT-JEE, CBSE, I.Sc. PU-II, Boards, CET, CEE, PET, IGCSE IB AP-Physics and other exams

Newton 's Law of Cooling by Prof. Subhashish Chattopadhyay SKMClasses Bangalore Useful for IIT-JEE, CBSE, I.Sc. PU-II, Boards, CET, CEE, PET, IGCSE IB AP-Physics and other exams

There are 3 kinds of Text Books

- The thin Books - Good students who want more details are not happy with these. Average students who need more examples are not happy with these. Most students who want to "Cram" quickly and pass somehow find the thin books "good" as they have to read less !!

- **The Thick Books - Most students do not like these, as they want to read as less as possible. Average students are "busy" with many other things and have no time to read all these.**

- The Average sized Books - Good students do not get all details in any one book. Most bad students do not want to read books of "this much thickness" also !!

We know there can be no shoe that's fits in all.

Printed books are not e-Books! Can't be downloaded and kept in hard-disc for reading "later"

So if you read this book later, you will get all kinds of examples in a single place. This becomes a very good "Reference Material". I sincerely wish that all find this "very useful".



Students who do not practice lots of problems, do not do well. The rules of "doing well" had never changed Will never change !

Newton 's Law of Cooling by Prof. Subhashish Chattopadhyay SKMClasses Bangalore Useful for IIT-JEE, CBSE, I.Sc. PU-II, Boards, CET, CEE, PET, IGCSE IB AP-Physics and other exams

Newton 's Law of Cooling by Prof. Subhashish Chattopadhyay SKMClasses Bangalore Useful for IIT-JEE, CBSE, I.Sc. PU-II, Boards, CET, CEE, PET, IGCSE IB AP-Physics and other exams

After 2016 CBSE Mathematics exam, lots of students complained that the paper was tough!

Updated 8:47 am Mar 22, 2016

IBNLIVE  

ENGLISH HINDI MARATHI



READ WATCH CRICKET TECH

LATEST BUDGET 2016 POLITICS INDIA SPORTS FOOTBALL MOVIES LIVE TV BUZZ WC

IBNLIVE » INDIA

CBSE assures remedial measures for tricky and tough Class XII Math paper

Posted on: 12:17 PM IST Mar 17, 2016 | Updated on: 12:20 pm, Mar 17, 2016 IST

IBNLIVE.COM    14 More+

After several students claimed that the Central Board of Secondary Education (CBSE) Class XII board Mathematics examination paper was 'tricky' and tough, the board has issued a clarification on remedial measures which are likely to be taken before evaluation.

The CBSE says that feedback received from various stakeholders like students, subject teachers and examiners will be put before the committee of subject experts.

close

Newton 's Law of Cooling by Prof. Subhashish Chattopadhyay SKMClasses Bangalore Useful for IIT-JEE, CBSE, I.Sc. PU-II, Boards, CET, CEE, PET, IGCSE IB AP-Physics and other exams

Newton 's Law of Cooling by Prof. Subhashish Chattopadhyay SKMClasses Bangalore Useful for IIT-JEE, CBSE, I.Sc. PU-II, Boards, CET, CEE, PET, IGCSE IB AP-Physics and other exams

On 21 st May 2016 the CBSE standard 12 result was declared. [I loved the headline](#)

INDIATODAY.IN NEW DELHI, MAY 21, 2016 | UPDATED 16:40 IST

CBSE Class 12 Results out: No leniency in Maths paper, high paper standard to be maintained in future

The CBSE Class 12 Mathematics board exam on March 14 reduced many students to tears as they found the paper quite lengthy and tough and many couldn't finish it on time. The results show an overall lowering of marks received in the Maths paper.



RELATED STORIES

- CBSE Board result 2016 declared! Thiruvananthapuram obtains the highest part percentage, check how your region scored
- Meet CBSE topper Sukriti Gupta: Check her percentage here!
- CBSE Class 12 Boards 2016: Results announced ahead of time!
- CBSE results declared at www.cbse.nic.in: Steps to check online
- Exclusive! CBSE declares Class 12 Results at www.cbseresults.nic.in and cbse.nic.in

The CBSE (Central Board of Secondary Education) Class 12 Board exam results have been announced today, i.e on May 21, around 10:30 am ahead of time. Students may check their scores at the official website, www.cbseresults.nic.in. (Read: **CBSE Class 12 Boards 2016: Results announced ahead of time! Check your score at cbseresults.nic.in**)

Newton 's Law of Cooling by Prof. Subhashish Chattopadhyay SKMClasses Bangalore Useful for IIT-JEE, CBSE, I.Sc. PU-II, Boards, CET, CEE, PET, IGCSE IB AP-Physics and other exams

Newton 's Law of Cooling by Prof. Subhashish Chattopadhyay SKMClasses Bangalore Useful for IIT-JEE, CBSE, I.Sc. PU-II, Boards, CET, CEE, PET, IGCSE IB AP-Physics and other exams

In 2015 also the same complain was there by many students

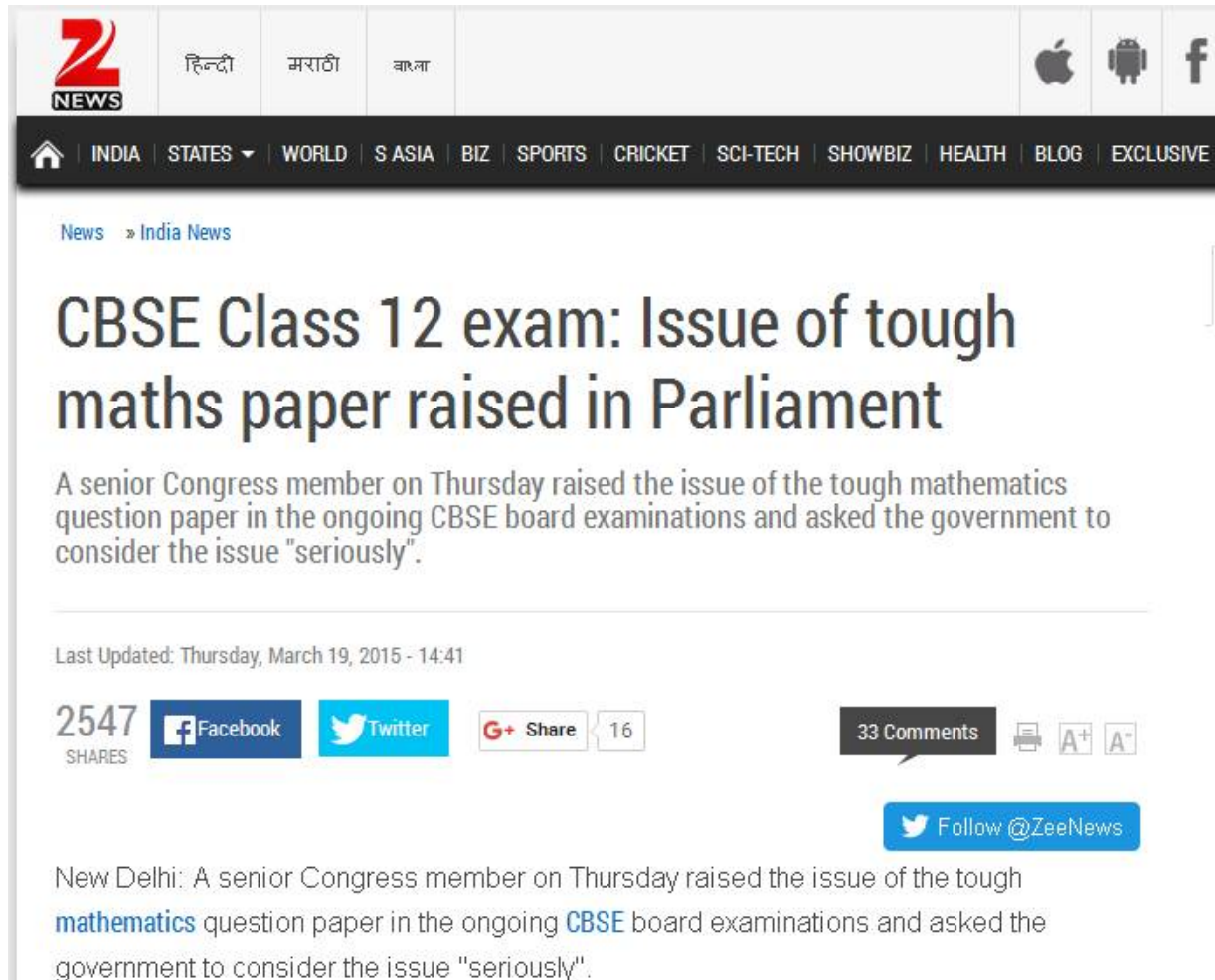

The screenshot shows a news article on the Zee News website. The header includes the Zee News logo, language options (Hindi, Marathi, Kannada), and mobile app icons (Apple, Android, Facebook). The navigation bar lists categories like India, States, World, S Asia, Biz, Sports, Cricket, Sci-Tech, Showbiz, Health, Blog, and Exclusive. The article title is "CBSE Class 12 exam: Issue of tough maths paper raised in Parliament". The sub-headline reads: "A senior Congress member on Thursday raised the issue of the tough mathematics question paper in the ongoing CBSE board examinations and asked the government to consider the issue 'seriously'." The article is dated "Last Updated: Thursday, March 19, 2015 - 14:41". It has 2547 shares (Facebook, Twitter, G+), 16 comments, and 33 comments. A "Follow @ZeeNews" button is also visible. The main text of the article is partially visible, starting with "New Delhi: A senior Congress member on Thursday raised the issue of the tough mathematics question paper in the ongoing CBSE board examinations and asked the government to consider the issue 'seriously'."

So we see that by raising frivolous requests, even upto parliament, actually does not help. Many times requests from several quarters have been put to CBSE, or Parliament etc for easy Math Paper. These kinds of requests actually can-not be entertained, never will be.

Newton 's Law of Cooling by Prof. Subhashish Chattopadhyay SKMClasses Bangalore Useful for IIT-JEE, CBSE, I.Sc. PU-II, Boards, CET, CEE, PET, IGCSE IB AP-Physics and other exams

Newton 's Law of Cooling by Prof. Subhashish Chattopadhyay SKMClasses Bangalore Useful for IIT-JEE, CBSE, I.Sc. PU-II, Boards, CET, CEE, PET, IGCSE IB AP-Physics and other exams

In March 2016, students of Karnataka PU-II also complained the same, regarding standard 12 (PU-II Mathematics Exam). Even though the Math Paper was identical to previous year, most students had not even solved the 2015 Question Paper.

Friday, March 25, 2016 - 13:28

The **NEWS** Minute

HOME NEWS ANDHRA KARNATAKA KERALA TAMIL NADU TELANGANA CULTURE MEDIA BLOG

Exams

Online petition for lenient evaluation of K'taka II PU math paper gets over 8000 supporters

The campaign, which was launched on Monday, has garnered over 8000 supporters

TNM Staff | Wednesday, March 16, 2016 - 09:32

[Follow @thenewsminute](#)

[Share](#) [Tweet](#) [Email](#) [Share](#) [Reddit](#)

Following a "very tough" math paper that left many II PU students in tears, Saket Ravindran a student launched an online campaign demanding lenient evaluation.

These complains are not new. In fact since last 40 years, (since my childhood), I always see this; every year the same setback, same complain!

In this e-Book I am trying to solve this problem. Those students who practice can learn.

No one can help those who are not studying, or practicing.

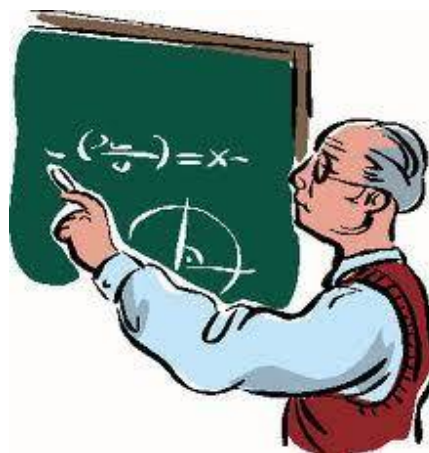

Newton 's Law of Cooling by Prof. Subhashish Chattopadhyay SKMClasses Bangalore Useful for IIT-JEE, CBSE, I.Sc. PU-II, Boards, CET, CEE, PET, IGCSE IB AP-Physics and other exams

Newton 's Law of Cooling by Prof. Subhashish Chattopadhyay SKMClasses Bangalore Useful for IIT-JEE, CBSE, I.Sc. PU-II, Boards, CET, CEE, PET, IGCSE IB AP-Physics and other exams

[Learn more at http://skmclasses.weebly.com/iit-jee-home-tuitions-bangalore.html](http://skmclasses.weebly.com/iit-jee-home-tuitions-bangalore.html)

[Twitter - https://twitter.com/ZookeeperPhy](https://twitter.com/ZookeeperPhy)

[Facebook - https://www.facebook.com/IIT.JEE.by.Prof.Subhashish/](https://www.facebook.com/IIT.JEE.by.Prof.Subhashish/)

[Blog - http://skmclasses.kinja.com](http://skmclasses.kinja.com)

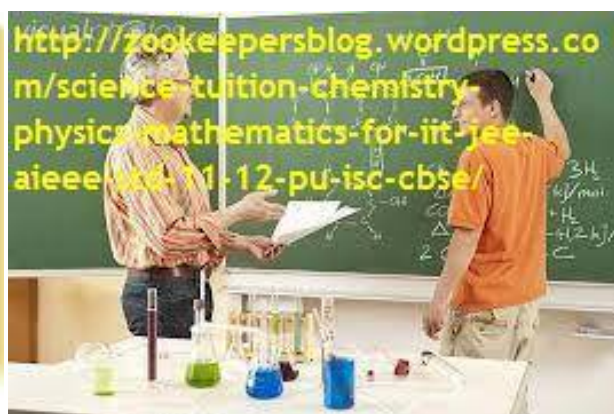

A very polite request :

I wish these e-Books are read only by Boys and Men. Girls and Women, better read something else; learn from somewhere else.

Newton 's Law of Cooling by Prof. Subhashish Chattopadhyay SKMClasses Bangalore Useful for IIT-JEE, CBSE, I.Sc. PU-II, Boards, CET, CEE, PET, IGCSE IB AP-Physics and other exams



Foreword for the Book, by Dr. Navsky Gupta

Director and Consultant, Shankar Netrika Eye Center, Mumbai

Studied at University of California, Irvine, and Volgograd Medical Academy

-

On human apes by the storytelling chimpanzee

My view of human apes

Let me be clear at the onset of my view. **I am not proud of my species which calls itself Homo sapiens.**

You just need to look our **sorry history** of **violence, warring and massacres over power, resources** and **religion**.



Newton 's Law of Cooling by Prof. Subhashish Chattopadhyay SKMClasses Bangalore Useful for IIT-JEE, CBSE, I.Sc. PU-II, Boards, CET, CEE, PET, IGCSE IB AP-Physics and other exams

I think, for the most part, the human ape thinks, acts and reproduces as do his great ape cousins. (they mate, have family, have culture etc. as shown by studies of Jane Goodall, Desmond Morris and many more)

[Our evolution of higher faculties](#)

Yet, for an ape, we have come a long way forward. The journey has been slow and arduous.

The first ape like humans probably arose (quiet literally) on their two feet some 5 to 7 million years ago (that is 50,000 to 70,000 centuries ago).

The great apes as a family go back 15 million years.

Somewhere down the line we developed imagination, curiosity, and the ability to consider "What if ?"

These qualities of imagination, curiosity and abstract thinking are vital components of storytelling so that when developed, a mere mention or even the thought of a word can evoke artificial, imaginative or real worlds in the mind.

[Other animals too have traits of intelligence](#)

We are not certain if our cousin great apes have it or not, and if they have, to what extent it is developed.

Curiosity is certainly very common in animal kingdom.

It is a human hubris to think that we are sole possessor of this facility.

Other animals are as curious as us including our cousin apes, cats, rodents to name a few?

Curiosity is an inquisitive thinking that involves observation, exploration, investigation, learning and finally changes in behavior.

Curiosity has survival and reproductive value which is essential for success of DNA transmission, the raison d'etre for any kind of life based on carbon and DNA.

Curiosity involves several neurological aspects such as motivation and reward, attention, memory and learning.

[Our crippling shortcomings](#)

The other thing that we humans need to be aware is that we are in the end apes and very flawed apes at that.

No doubt we have higher intelligence and contemplate abstract thinking.

Yet, our evolutionary mind uses principles that had served us well when we were hunter-gatherers in the African savannas but now do us grave injustice.

Newton 's Law of Cooling by Prof. Subhashish Chattopadhyay SKMClasses Bangalore Useful for IIT-JEE, CBSE, I.Sc. PU-II, Boards, CET, CEE, PET, IGCSE IB AP-Physics and other exams

Newton 's Law of Cooling by Prof. Subhashish Chattopadhyay SKMClasses Bangalore Useful for IIT-JEE, CBSE, I.Sc. PU-II, Boards, CET, CEE, PET, IGCSE IB AP-Physics and other exams

They are termed cognitive fallacies.

The list of these heuristics (mental shortcuts), biases, is devastatingly huge and long.

They become a fertile ground for the breeding of irrationality in human apes.

Worse, irrationality is highly contagious.

[Classification of cognitive biases](#)

These cognitive biases are divided into three categories:

1. Decision making and belief biases:

There are more than 80 of these.

One good example is the **bandwagon effect** or the **herd mentality**. This explains how easily a temple, or church or a statue gets tagged as "lucky".

2. Social biases

There are at least 25 of these.

The classic one being, the just-world hypothesis also known as the moral luck. It is a belief that good stuff happens to virtuous and ill happens to the diabolical, deservingly of course.

Another good example is the **Barnum effect** (closely related to subjective validation) wherein an individual considers a general and a vague statement highly specific to his or her own personality.

Example: Disciplined and self controlled outside, you tend to be worrisome and insecure inside.

[Entire chicanery of astrology, palmistry and astrology are based on this one bias.](#)

3. Memory errors and biases

There are at least 60 of them

The peak-end rule is a suitable example. It is the assessment of any experience by an individual largely on how they felt it at its peak and at its termination. This has a special significance for medical procedures and surgeries.

[Limitations of curiosity, logic and abstract thinking](#)

You will realize that just being curious and having the ability of abstract thinking is not enough.

These two generally end up in giving rise to either philosophy or worse, religion.

Newton 's Law of Cooling by Prof. Subhashish Chattopadhyay SKMClasses Bangalore Useful for IIT-JEE, CBSE, I.Sc. PU-II, Boards, CET, CEE, PET, IGCSE IB AP-Physics and other exams

Newton 's Law of Cooling by Prof. Subhashish Chattopadhyay SKMClasses Bangalore Useful for IIT-JEE, CBSE, I.Sc. PU-II, Boards, CET, CEE, PET, IGCSE IB AP-Physics and other exams

These traits alone would very likely have us end up in creating a world view that is largely hopeful, helpful and endearing but factually incorrect.

This in fact did happen for most of the time in human history.

Added with these two, if one begins to apply logic and proofs, the brain is capable of generating powerful mathematics.

Yet, all these devices and tools namely curiosity, imagination, logic and mathematical proofs have proved themselves deficient in curbing our remarkable ability to fool ourselves.

[Experimental Science is the best tool ever devised to understand reality](#)

The only tool and the best method that we humans came up with understanding reality is experimentation, particularly well controlled, repeatable verifiable experiments that can minimize the experimenter's bias.

In medicine, the gold standard of drug testing for its efficacy and safety is the placebo controlled double blind clinical trial.

It is not an easy task to conduct an original experiment.

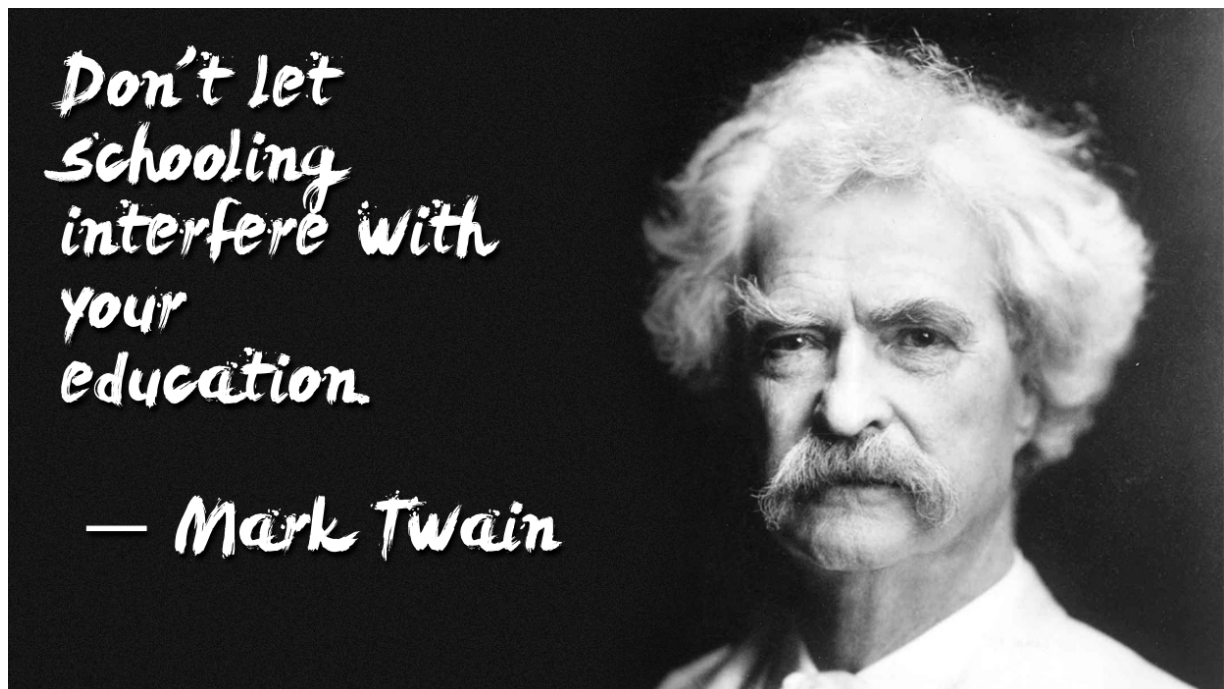

Newton 's Law of Cooling by Prof. Subhashish Chattopadhyay SKMClasses Bangalore Useful for IIT-JEE, CBSE, I.Sc. PU-II, Boards, CET, CEE, PET, IGCSE IB AP-Physics and other exams

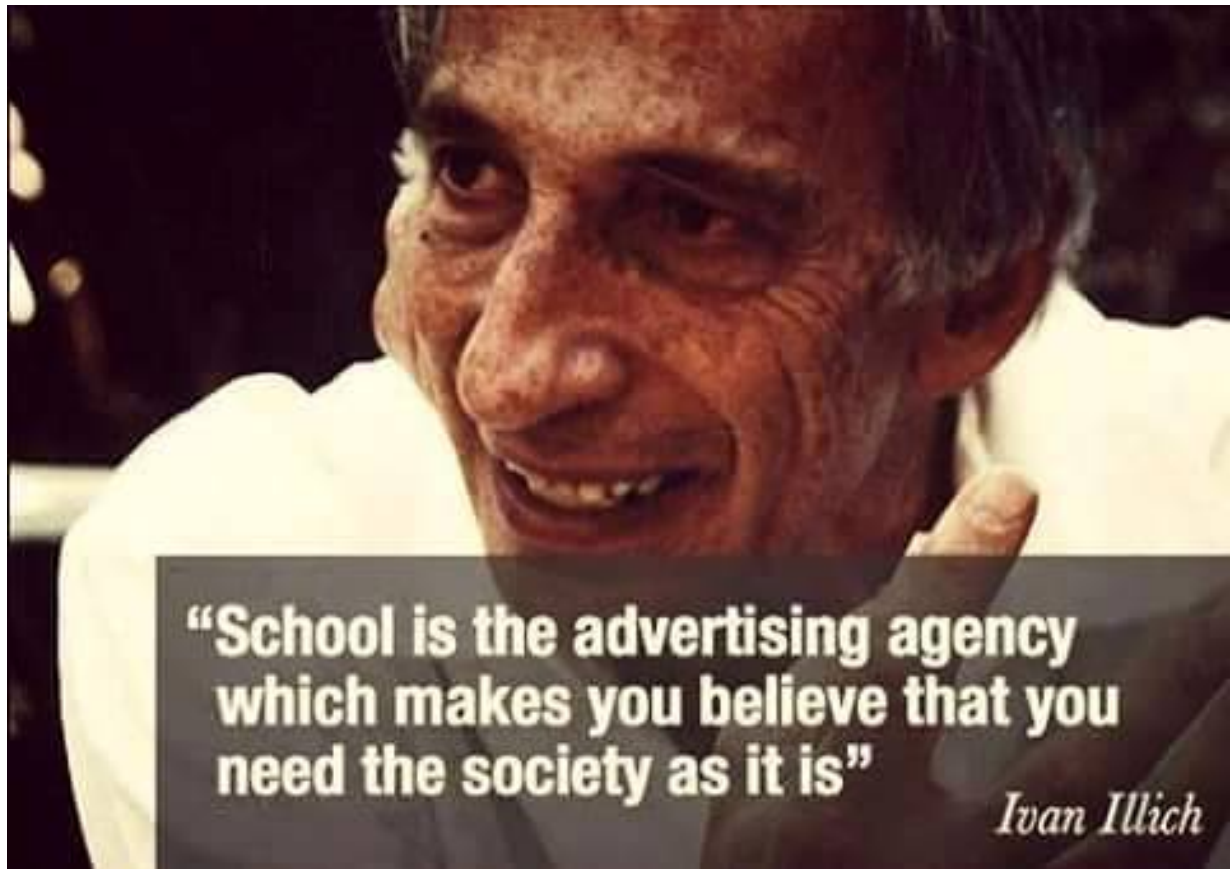

Education's Biggest Failure

Our school education's profoundest failure is exactly this.

It does not inculcate either questioning or original thinking or more specifically critical thinking.

We fail to teach our students the idea of how to propose a hypothesis and go about testing it.

Our schooling fails to provide to even the best outgoing student the notion of conceiving an original experiment to prove or disprove an idea.

Only few people are good experimentalists, meaning they take care to isolate their study from events that can undue influence its outcome.

The most important aspect about the experimental findings is that it should be repeatable, verifiable by other people who repeat them under similar conditions in other places.

It is the one biggest universal failure of education system all over the world.

Education is currently seen as a way to attain professional career and job security which is not bad per se.

Newton 's Law of Cooling by Prof. Subhashish Chattopadhyay SKMClasses Bangalore Useful for IIT-JEE, CBSE, I.Sc. PU-II, Boards, CET, CEE, PET, IGCSE IB AP-Physics and other exams

But something very important has been lost.

Do we encourage a student to write an original paper?

Do we encourage a student to ever lay out a plan for considering an original experiment?

In fact, in our education, do we even mention that so many unknown things remain to discover.

May be it is so that there is now so much to know that it overwhelms a young mind.

At least most young minds.



[The reason for the failure of education](#)

What prevents us from imparting the type of education we often know about, speak about but fail to carry out?

You will be surprised at the answer.

It is overpopulation; too many of us human apes.

Newton 's Law of Cooling by Prof. Subhashish Chattopadhyay SKMClasses Bangalore Useful for IIT-JEE, CBSE, I.Sc. PU-II, Boards, CET, CEE, PET, IGCSE IB AP-Physics and other exams

Newton 's Law of Cooling by Prof. Subhashish Chattopadhyay SKMClasses Bangalore Useful for IIT-JEE, CBSE, I.Sc. PU-II, Boards, CET, CEE, PET, IGCSE IB AP-Physics and other exams

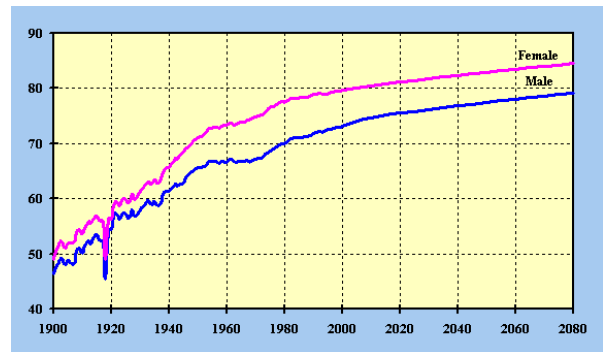
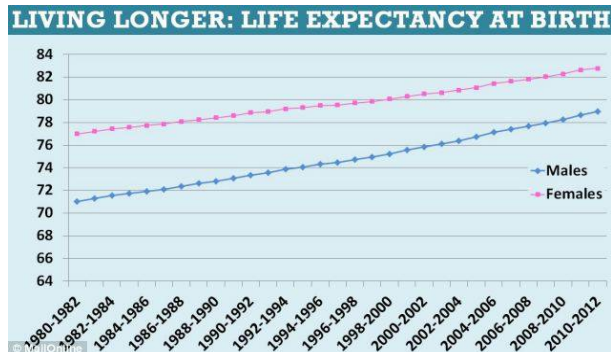

(Did you notice Female Life expectancy is always higher than Men ! Do you know why ?)

If someone were to ask me what is the key problem today, I would say that we are simply too many of us today.

India or South Asia is an extreme example but almost all the nations face this hideous calamity.

Are nation states able to provide clean air and water to their citizens?

Are they able to provide a basic housing to their citizens?

Are they able to provide even basic level healthcare to their citizens?

What about jobs?

Many argue between capitalism, socialism, mixed system and so on and so forth.

I think they keep missing the key issue.

Denial is probably the right word.

Such a populace simply cannot be given the fundamental rights as enshrined in the constitutions of most nation states.

Most would not sit to listen to this and may get up and leave in protest.

[Stating the problem](#)

But let me make my case.

Just feeding, giving clean water and jobs is not the way we should be looking at the citizens of the world; though even that itself is a herculean task and even the most developed nation states are grappling with the problem.

I want to go beyond this.

Why has education, the process of acquiring knowledge become such a painful task for most young people?

Newton 's Law of Cooling by Prof. Subhashish Chattopadhyay SKMClasses Bangalore Useful for IIT-JEE, CBSE, I.Sc. PU-II, Boards, CET, CEE, PET, IGCSE IB AP-Physics and other exams

Newton 's Law of Cooling by Prof. Subhashish Chattopadhyay SKMClasses Bangalore Useful for IIT-JEE, CBSE, I.Sc. PU-II, Boards, CET, CEE, PET, IGCSE IB AP-Physics and other exams

Let us see this step by step.

For starters, every child right from a day she is born needs a decent health care and nutrition.

The idea is to get very good schooling.

Good schools are few and the race starts right here.



Only very few percentage of humans born will get good schooling.

Second step, after the school, it is the college.



The idea of scoring top percentages is to get into the best colleges.

We all know that in general in any country, including the United States, only a tiny percentage of colleges or universities offer a life enhancing and transforming program.

Good education needs great teachers.

Great and dedicated teachers are a rarity as a society can afford to pay and reward only a handful of good teachers, professors.

Newton 's Law of Cooling by Prof. Subhashish Chattopadhyay SKMClasses Bangalore Useful for IIT-JEE, CBSE, I.Sc. PU-II, Boards, CET, CEE, PET, IGCSE IB AP-Physics and other exams

Newton 's Law of Cooling by Prof. Subhashish Chattopadhyay SKMClasses Bangalore Useful for IIT-JEE, CBSE, I.Sc. PU-II, Boards, CET, CEE, PET, IGCSE IB AP-Physics and other exams



Following that, we have the problem of jobs or a professional career.

Here again one encounters a cut throat competition and only a few will land up with a satisfactory job.

As it is, most of us humans are average and really not very productive for a society.

In fact, most of us can be or turn out to be a burden for the society.

A planet that has fewer people, can be better educated, can be given better lives, and can be given better policing /security and a speedier and effective justice.

Crime itself will come down.

The lesser we are, the more we will care for each other.

Moreover, more productive and educated people are more likely to contribute funds not only for the resources needed to run a society but to higher pursuits of sciences and mathematics.

This idea is extremely repulsive and disgusting to nearly everybody as it goes against our biological drive, our most primal instinct.

But what needs to be done must be done.

Otherwise we will be doomed to mediocrity and worse, nightmarish suffering that is visible all around us.

Someone asked me the one biggest mistake we have made.

I think it is this.

We have allowed runaway breeding of ourselves.

Newton 's Law of Cooling by Prof. Subhashish Chattopadhyay SKMClasses Bangalore Useful for IIT-JEE, CBSE, I.Sc. PU-II, Boards, CET, CEE, PET, IGCSE IB AP-Physics and other exams



If we wish all schools to impart scientific teaching and inculcate scientific methods, we need to have fewer of them very good ones with better facilities with fewer pupils to care after.

Just being a few would increase love and tolerance for each other and further our cooperation.

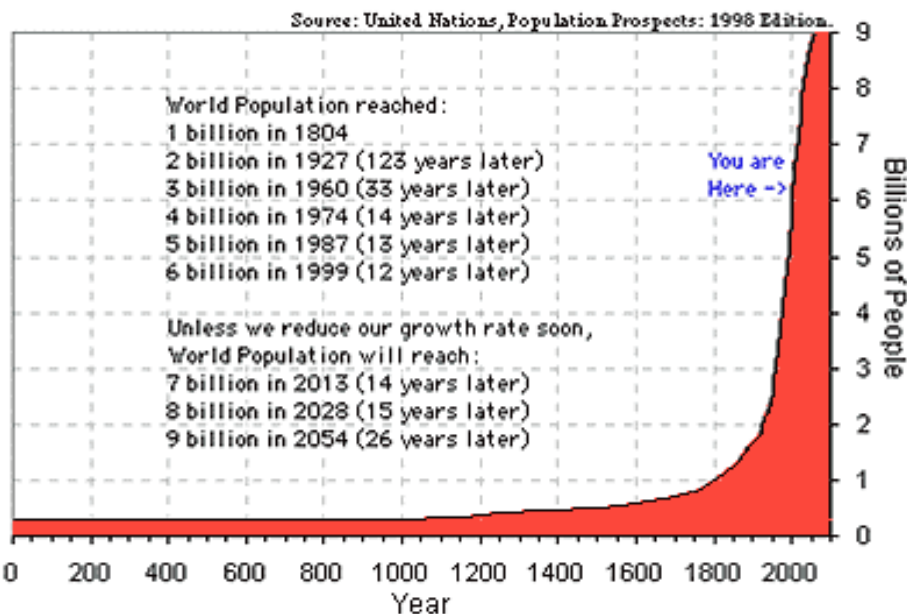
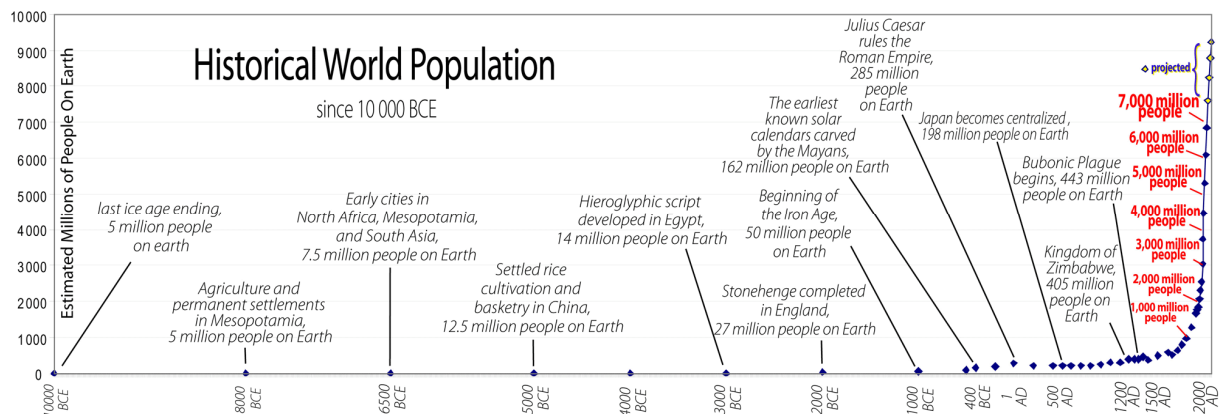

Newton 's Law of Cooling by Prof. Subhashish Chattopadhyay SKMClasses Bangalore Useful for IIT-JEE, CBSE, I.Sc. PU-II, Boards, CET, CEE, PET, IGCSE IB AP-Physics and other exams

[Going one step further](#)

In this context, another important pops up.

We are aware that resources are scare, may it be for education, for health, for research, for fuels, for energy.

We, if are intelligent, and rational enough; must plan our death once we realize that our contribution to the society is nil.

After that, we become a parasite and a hindrance for the younger generation who exist and who are to come.

[This is one of the biggest prices we are paying for the success of medicine.](#)

Ageing and geriatric diseases are taking a huge toll on the national economies, especially of the developed world where the state bears the expenses of the early to a large extent.

Finally when the time comes, one needs to embrace death by making death peaceful, planned and curbing our greedy desire to go on and on.

Story Telling Chimpanzee

See <http://panarrans.blogspot.in/>

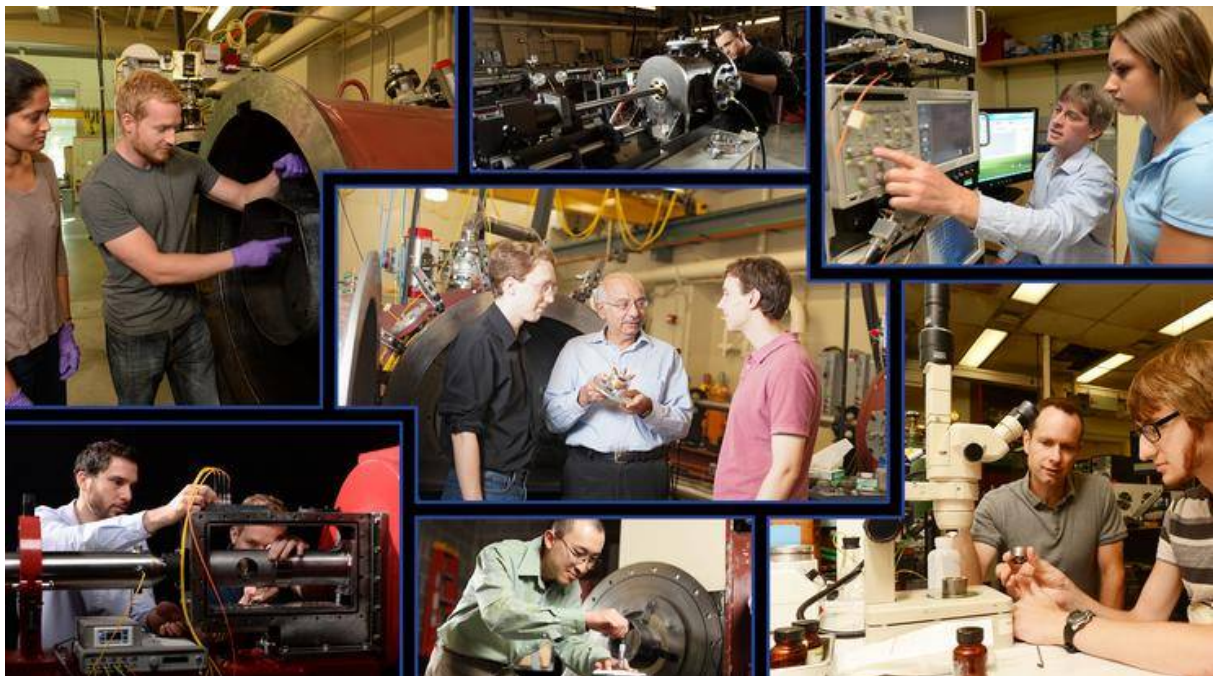

Newton 's Law of Cooling by Prof. Subhashish Chattopadhyay SKMClasses Bangalore Useful for IIT-JEE, CBSE, I.Sc. PU-II, Boards, CET, CEE, PET, IGCSE IB AP-Physics and other exams

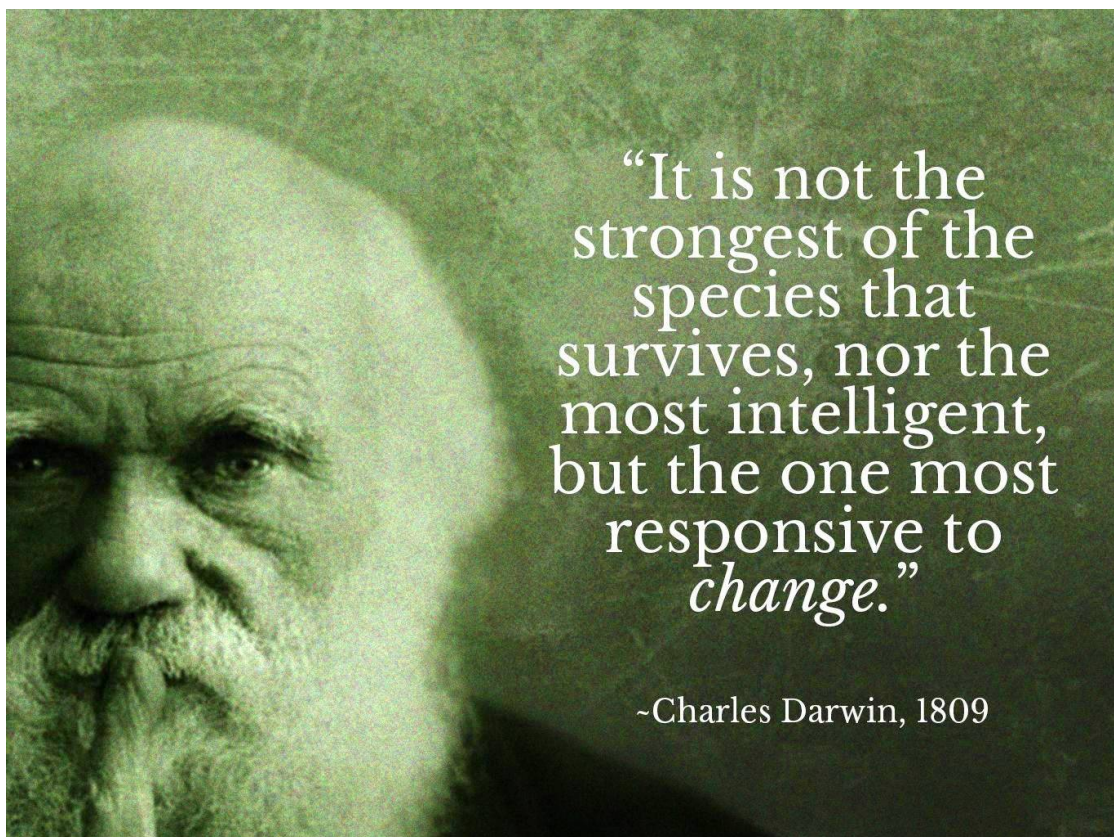
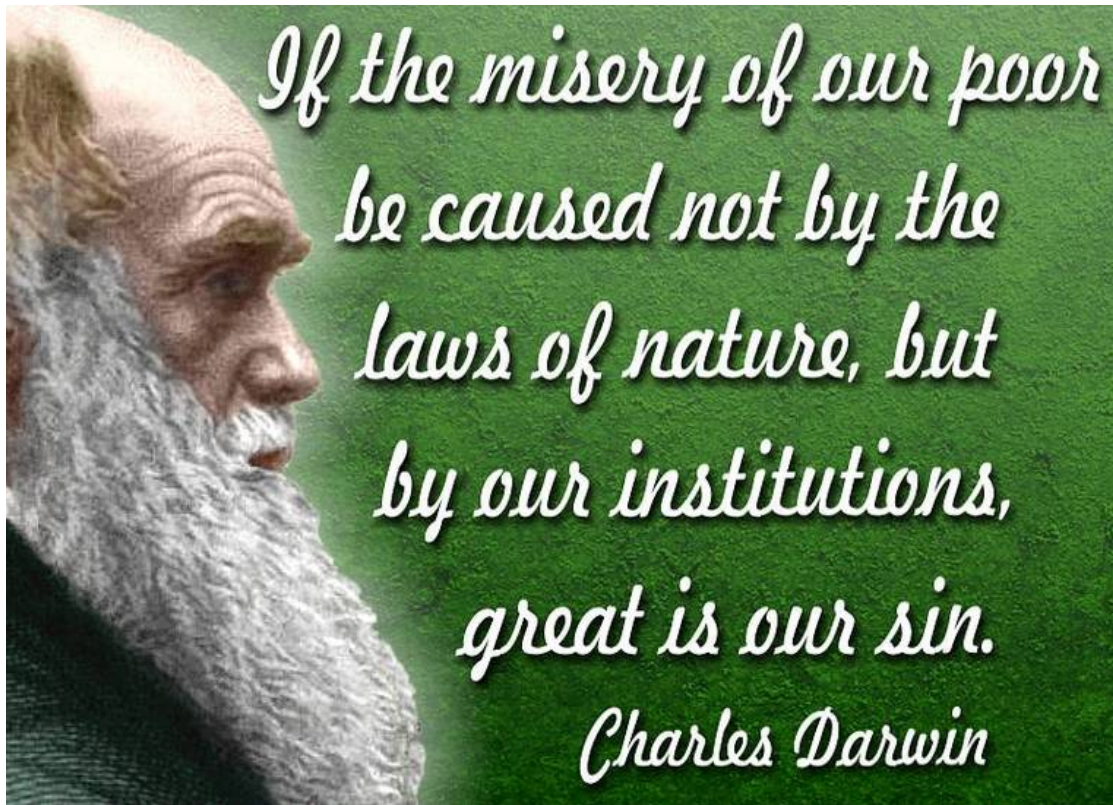

Newton 's Law of Cooling by Prof. Subhashish Chattopadhyay SKMClasses Bangalore Useful for IIT-JEE, CBSE, I.Sc. PU-II, Boards, CET, CEE, PET, IGCSE IB AP-Physics and other exams

The Rich and Poor divide is very huge in this world. Privileged are those who have the luxury to sue someone or other for slightest "discomfort". In some cases "mental discomfort" is sighted as the cause for suing

Larksville woman sues county over son's injuries at park

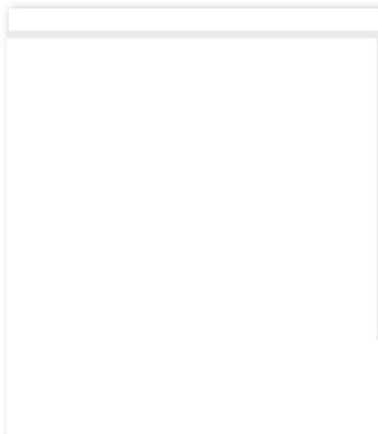

ERIC MARK / PUBLISHED: OCTOBER 24, 2014

A Larksville woman whose son was injured at Seven Tubs Nature Area in Bear Creek Township has sued Luzerne County, claiming negligence.

Melissa Moser, in a suit filed in Luzerne County Court on Thursday, claims that her 14-year-old son was badly hurt when a concrete barrier fell on him and trapped him during a family outing to the county-owned park on May 13. The boy was playing near a parking lot with his siblings when the traffic-control barrier tipped and fell on him, according to court papers.

We do not have the same rules or facilities for all in this world. See the images below and think who these poor men can sue? Can they sue anyone? Do they have money to sue anyone?



These poor men can't afford hearse service. Nor there is any Public help or support. Can they sue anyone for "mental discomfort" and / or agony ? Society has pampered rich women with privileged laws and facilities. **In contrast poor boys and Men are always left to fend themselves.**

Newton 's Law of Cooling by Prof. Subhashish Chattopadhyay SKMClasses Bangalore Useful for IIT-JEE, CBSE, I.Sc. PU-II, Boards, CET, CEE, PET, IGCSE IB AP-Physics and other exams

Newton 's Law of Cooling by Prof. Subhashish Chattopadhyay SKMClasses Bangalore Useful for IIT-JEE, CBSE, I.Sc. PU-II, Boards, CET, CEE, PET, IGCSE IB AP-Physics and other exams

This book is dedicated to the following greats who **died in Poverty**, yet did their best in the subjects, they were passionate in. I couldn't achieve infinitesimal part of their passion even being so well to do!



1) **Nikolai Ivanovich Lobachevsky** (Kazan, Russia) 1823 - known primarily for his work on hyperbolic geometry, otherwise known as Lobachevskian geometry. William Kingdon Clifford called Lobachevsky the "Copernicus of Geometry" due to the revolutionary character of his work. He was dismissed from the university in 1846, ostensibly due to his deteriorating health: by the early 1850s, he was nearly blind and unable to walk. He died in poverty in 1856.

Nikolai was an atheist.



2) **Egon Schiele** - Prolific artist Egon Schiele succumbed to the Spanish Influenza that took 20,000,000 lives in Europe in 1918. Schiele 's wife Edith (who was six months pregnant at the time) died three days before him in their tiny apartment in Vienna. They were **broke and hungry**, and Schiele spent as much time as he could drawing. He was only 28 years old and spent his last moments alone drawing his wife's body before his own untimely death.

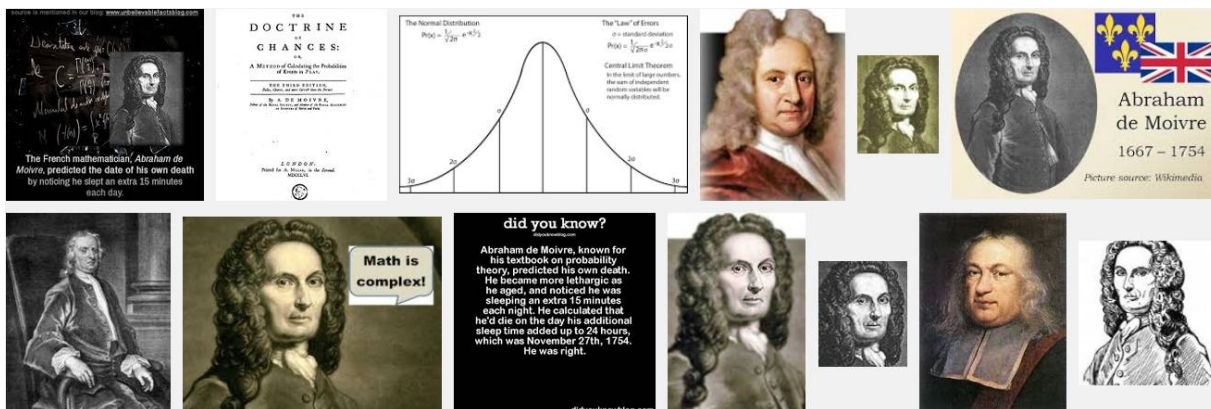

Newton 's Law of Cooling by Prof. Subhashish Chattopadhyay SKMClasses Bangalore Useful for IIT-JEE, CBSE, I.Sc. PU-II, Boards, CET, CEE, PET, IGCSE IB AP-Physics and other exams

Newton 's Law of Cooling by Prof. Subhashish Chattopadhyay SKMClasses Bangalore Useful for IIT-JEE, CBSE, I.Sc. PU-II, Boards, CET, CEE, PET, IGCSE IB AP-Physics and other exams

3) **Abraham de Moivre** 1667-1754 (87, natural causes) Despite being a gifted and renowned mathematician in France, de Moivre spent much of his life in poverty. He was a Calvinist, and when the Edict of Nantes was revoked in 1685 (a decision that is unequivocally considered to have damaged France), de Moivre left France for England. He remained virtually destitute, de Moivre was unable to secure employment and was often known to play chess for money in order to afford sustenance. Eventually succumbing to the ravages of poverty and old age, de Moivre predicted the day of his own death using a simple arithmetic progression in the number of hours he slept per day. The day he predicted 24 hours of sleep was the day he died.



4) **Domenikos Theotokopoulos** AKA **El Greco** - Master of the Spanish Renaissance who studied under Titian, El Greco was known for his contorted figures in his paintings. Born in 1541, El Greco as he came to be known, studied in Rome before moving to Spain. What he wasn't known for was being a huge ladies man, or family man, as he followed various studios and painting masters across Europe. Some of his best known works were created for the Spanish royal family. El Greco was able to make a living as an artist for some time before he fell out of favor and became the subject of ridicule. He served as an inspiration for painters that brought forth the Expressionist and Cubist movements. Unfortunately after his work was scorned and laughed at he was unable to continue to make a living as a painter. It wasn't until 250 years after he died that the rest of the art world noticed his paintings. He was a big careerist and was described in letters in 1563 as a "maestro Domenico" a "master" when he was just 22 years old. He died unrecognised and alone in Toledo, Spain on the 7th of April 1614.

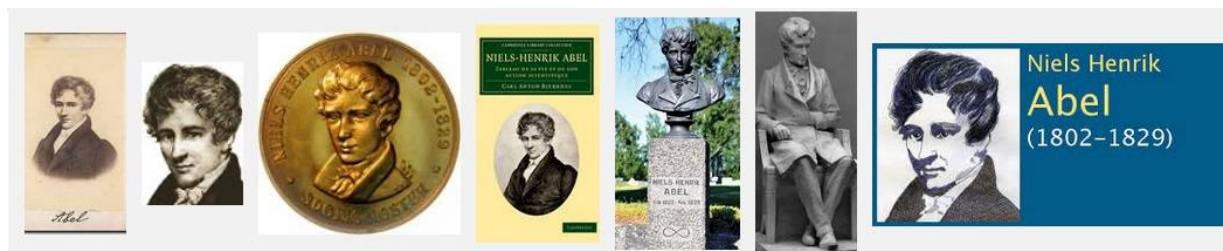

Newton 's Law of Cooling by Prof. Subhashish Chattopadhyay SKMClasses Bangalore Useful for IIT-JEE, CBSE, I.Sc. PU-II, Boards, CET, CEE, PET, IGCSE IB AP-Physics and other exams

5) **Niels Abel** (1802-1829 Age - 26, pneumonia) **Plagued by poverty** and a lack of renown, Abel and his work went unrecognized during his lifetime. He spent time in Paris hoping to gain recognition and publish his work, but was unable to afford adequate means to sustain his health. In addition to being underfed, Abel contracted pneumonia. His pneumonia worsened on a trip to visit his fiancée for Christmas. He soon died, only two days before a letter arrived indicating that a friend had managed to find secure him a place as a professor in Paris. He never saw his work take root, nor did he ever secure a paying job as a mathematician, nor did he have opportunity to marry his fiancée.



6) **Oscar Wilde** - His famous last words really set the tone for Oscar Wilde's end, "My wallpaper and I are fighting a duel to the death. Though Wilde was a celebrity of the age and his works sold well, he was known to have extravagant spending habits. One or other of us has got to go." After his imprisonment he had been given a very small yearly allowance from the estate of his deceased wife, and was not helped at all by his former lover Lord Alfred Douglas, who had at that time just inherited a large sum. Living essentially **in poverty** in Paris, he was known to wander, bumping into old friends and spending what little cash remained on alcohol. Reportedly, when a doctor attending to him during his last days asked to be paid for his services, Wilde joked that he would die as he had lived - beyond his means. He passed away in a hotel room in Paris **completely bankrupt** from paying legal fees for his arrest and imprisonment for the crime of homosexuality. If that wasn't bleak and cruel enough, it was during this period that his works were becoming extremely popular. Unnnfairrrrrrr.



Newton 's Law of Cooling by Prof. Subhashish Chattopadhyay SKMClasses Bangalore Useful for IIT-JEE, CBSE, I.Sc. PU-II, Boards, CET, CEE, PET, IGCSE IB AP-Physics and other exams

7) **Frank Ramsey** 1903-1930 (26, jaundice) Ramsey is known for his work in mathematics, specifically combinatorics and logic/foundations, but is also remembered as a gifted philosopher and economist. Ramsey suffered from lifelong liver problems, and was often unable to focus on work for more than a few hours a day. In spite of this, he gained renown as a promising young philosopher and mathematician, until a severe attack of jaundice hospitalized him in 1930. He died during an operation meant to alleviate the problem.



8) **Claude Monet** - As the founder of French Impressionism, Monet's paintings usually dealt with landscape scenes in a moment. While his seminal work "Impression, Sunrise" is now studied and appreciated in art colleges around the world, it was widely derided by critics when it was first revealed. Monet received little but abuse from public and critics alike, who complained that the paintings were formless, unfinished, and ugly. He and his family **endured abject poverty**. By the 1880s, however, his paintings started selling.



9) **Srinivasa Ramanujan** 1887-1920 (32, malnutrition/hepatic amebiosis) The story of Ramanujan is well known among mathematicians, if not in general. Described as a prodigy, savant, genius, etc., Ramanujan taught himself mathematics as a youth and began to devise results in analytical number theory and other areas of mathematics in isolation. **He was quite poor and unable to afford school**, and his exclusive devotion to mathematics precluded him from scholarship funding. He spent much of his life seriously ill, and spent a fair amount of time unable to secure any position as a scholar or mathematician. Eventually, he came to England to work with G.H. Hardy. Sadly, his long-term illness continued, and he succumbed to a combination of malnutrition and a parasitic liver infection.

Newton 's Law of Cooling by Prof. Subhashish Chattopadhyay SKMClasses Bangalore Useful for IIT-JEE, CBSE, I.Sc. PU-II, Boards, CET, CEE, PET, IGCSE IB AP-Physics and other exams

Newton 's Law of Cooling by Prof. Subhashish Chattopadhyay SKMClasses Bangalore Useful for IIT-JEE, CBSE, I.Sc. PU-II, Boards, CET, CEE, PET, IGCSE IB AP-Physics and other exams



10) **Vincent Van Gogh** - It is hard not to think of tragedy when considers the life of Vincent Van Gogh. If there was ever a fine line between madness and genius, Vincent Van Gogh crossed it quite early in his career. Without his time in insane asylums and self-inflicted ear mutilation, the world would have never had "The Starry Night" and "The Potato Eaters." Despite his countless post-Impressionist chefs-d'oeuvre, Van Gogh only sold one painting in his lifetime. It sold for the equivalent of approximately \$109 dollars. Although he is famous for his works such as "The Starry Night" this artist battled mental illness most of his life. Unfortunately he finally lost this battle and cut his ear off in 1888, committing suicide not long after that by shooting himself in the chest. His last words were, "The sadness will last forever." **He died broke and destitute.**

See <https://zookeepersblog.wordpress.com/vincent-van-gogh-who-preferred-to-paint-without-eating/>

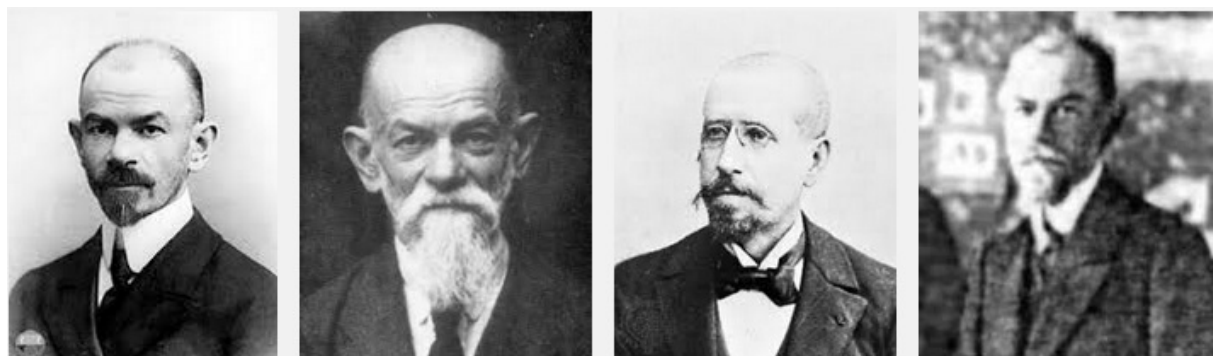

11) **Dmitri Egorov** 1869-1931 (61, starvation) Egorov made important contributions in the areas of analysis, differential geometry, and integral equations, including a fundamental result named for him in real analysis. Luzin was Egorov's first student, and was one member of a school that developed under Egorov to study real functions. Egorov became a leader and administrator in the Moscow Mathematical Society and at the Institute for Mechanics and Mathematics at Moscow State University. Egorov became a vocal opponent to the anti-religious persecution in the time following the Russian revolution, and was dismissed from the IMM. However, he remained active and well-respected in his position in the MMS, supported

Newton 's Law of Cooling by Prof. Subhashish Chattopadhyay SKMClasses Bangalore Useful for IIT-JEE, CBSE, I.Sc. PU-II, Boards, CET, CEE, PET, IGCSE IB AP-Physics and other exams

by his peers in the organization. Outside influences began to manipulate the society, and within a year, Egorov was dismissed from his position and arrested. He went on a hunger strike in prison and died in the prison hospital (or, as some reports state, at a colleague's home).



12) **Johannes Vermeer** - Vermeer was a 17th-century painter with eleven children, massive debt and a habit of working very slowly and painstakingly on his paintings. While Vermeer painted the "Girl with a Pearl Earring," he certainly was not draped in them during his life. Instead of having the elite or nobility commission works, Vermeer's genre of painting was catered to the provincial middle class. After the French invaded the Netherlands in 1672, the Dutch economy suffered terribly and Vermeer was left in hopeless debt. He suffered from a number of physical afflictions as well as mental illness. In 1675 Vermeer borrowed money in Amsterdam, using his mother-in-law as a surety. Soon after, the Dutch genre painter actually left his family in debt upon his death. After his death some of his paintings (he created about 40 in his lifetime) were sold with the names of other artists on them to make them more valuable. It took three centuries for Vermeer to be recognized as a master painter of the Dutch Golden Age for his use of light, tranquility and the unusual subject matter of peasants that populated his works. Though he did have patrons who paid him, he never made much and lived on the verge of poverty much of his life, eventually leaving his family in debt when he died at age 43.

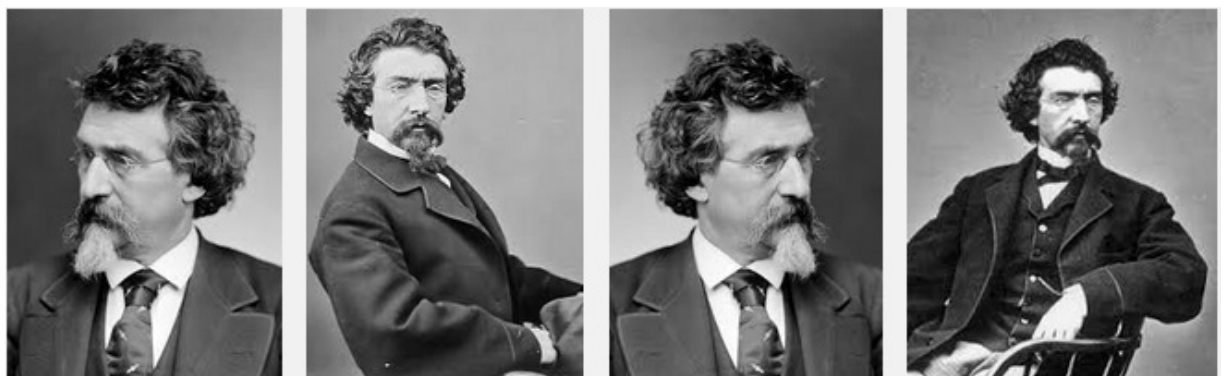

13) Mathew Brady - The "Father of Photojournalism" is best known for his invaluable photographs of the American Civil War. Though he was a successful and well-known portrait

Newton 's Law of Cooling by Prof. Subhashish Chattopadhyay SKMClasses Bangalore Useful for IIT-JEE, CBSE, I.Sc. PU-II, Boards, CET, CEE, PET, IGCSE IB AP-Physics and other exams

photographer before the war began (Abraham Lincoln's likeness on the \$5 bill is modeled after Brady's portrait of him), he spent around \$100,000 during the war on his photographs, which numbered in the thousands. The pictures brought the truth and grotesque horror of the war to the doorsteps of all Americans - a marked change from the propaganda and half-truths coming from print journalists at the time. Unfortunately, after the war no one wanted to be reminded of the horrors of it, and Brady was unable to sell his photographs or recoup his losses. Eventually Congress bought his collection for a mere \$2,840, but Brady's life had already been **ruined by poverty and alcoholism**, and he died in relative obscurity in 1896.

-

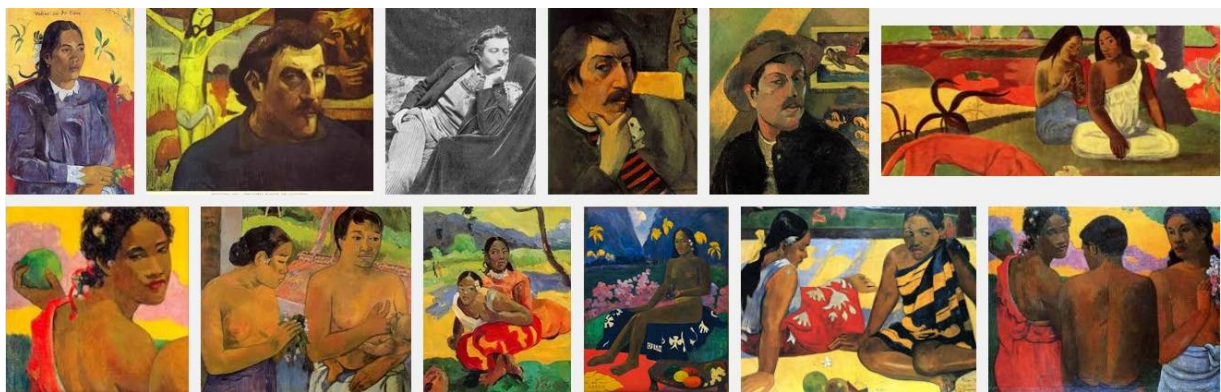

14) **Paul Gauguin** - Poverty became Gauguin's reality. Then his favorite daughter Aline died of pneumonia and Clovis, his son, died from a blood infection. Gauguin's escapades were far more exotic than his peers which eventually landed him in French Polynesia. There, he produced masterpieces like "Spirit of the Dead Watching," which largely inspired primitivism - an important art movement of the 19th century. **After many years of poverty and sickness**, Gauguin died from heart failure, alone and unaware of the mark his art would later make on the 20th century.

-

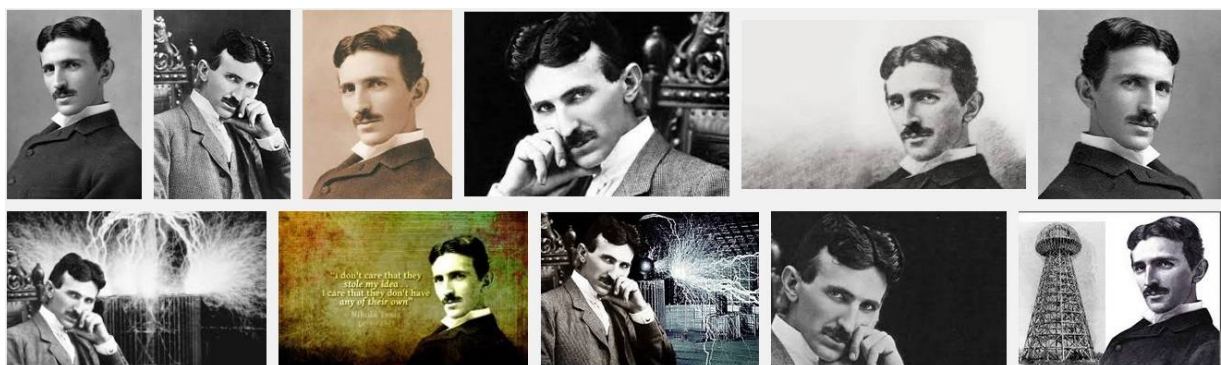

15) Nikola Tesla - Early in the 20th century, brilliant scientist Nikola Tesla was a world-famous inventor and regular headline news-maker. As for genius, we have Tesla to thank for alternating current, radio, wireless technology, neon lamps, and X-rays. Sadly, Tesla's life

Newton 's Law of Cooling by Prof. Subhashish Chattopadhyay SKMClasses Bangalore Useful for IIT-JEE, CBSE, I.Sc. PU-II, Boards, CET, CEE, PET, IGCSE IB AP-Physics and other exams

Newton 's Law of Cooling by Prof. Subhashish Chattopadhyay SKMClasses Bangalore Useful for IIT-JEE, CBSE, I.Sc. PU-II, Boards, CET, CEE, PET, IGCSE IB AP-Physics and other exams

was a series of run-ins with guys like Thomas Edison, who famously stiffed Tesla out of \$50,000, and Guglielmo Marconi, who stole the credit for the invention of the radio by using 17 of Tesla's patents. Tesla died penniless in 1943 in the New Yorker Hotel, where he had lived for 10 years after being evicted from another hotel for not paying his bill.



16) **Stephen Foster** - Though you may not be familiar with Stephen Foster's name, you undoubtedly know his songs. Foster is considered the "Father of American Music," penning the works "Camptown Races," "Swanee River," "Jeanie With the Light Brown Hair," "Beautiful Dreamer" and "Oh! Susanna" among many others, some of which function as current state songs. Foster's melodies were popular in his time (and remain so today, despite some controversy), and he wished to make a living as a professional songwriter. Unfortunately, the lack of copyright laws or a structure for the payment of royalties meant Foster made very little to nothing on performances and reprints of his work. Foster died at the age of 37 with 38 cents in his pocket.



17) **Jean-Honore Fragonard** - Jean-Honore Fragonard was born in Grasse, Provençal in 1732 and became one of the most famous painters of the Rococo period. His family moved to France in 1738, where he was heavily influenced by the Baroque style. His art career started out promisingly enough, having attended the Ecole Royale des Eleves Protégés in Paris. Fragonard was then sent to Italy, where he spent time at the French academy in Rome. He had some success after returning to France, preferring to do private commissioned work. Some of his best known pieces were "Coresus and Callirhoe" and "The Swing". He was well-known for his sensual and erotic style, complimented by his sense of whimsy and fantasy.

Newton 's Law of Cooling by Prof. Subhashish Chattopadhyay SKMClasses Bangalore Useful for IIT-JEE, CBSE, I.Sc. PU-II, Boards, CET, CEE, PET, IGCSE IB AP-Physics and other exams

Newton 's Law of Cooling by Prof. Subhashish Chattopadhyay SKMClasses Bangalore Useful for IIT-JEE, CBSE, I.Sc. PU-II, Boards, CET, CEE, PET, IGCSE IB AP-Physics and other exams

Unfortunately, Fragonard was unable to adapt to the new style that eventually came into popularity over "Rococo" called "Neo-classical". That ended his career and he died in relative obscurity and **poverty** in 1806.



18) **Herman Melville** - The celebration of the Moby Dick author's genius did not begin until well after he could enjoy — or profit from — the recognition. It took a solid 30 years after Herman Melville's death before his epic whaling novel was recognized as a masterpiece of American literature. By then he had long since abandoned any hopes of living off his writing, instead working as a customs inspector for 19 years. When he died of a heart attack in 1891, he **was broke and virtually unknown**. The only paper to mention his passing referred to him as a "long forgotten" author.



19) **James Barry** - James Barry born in Ireland in 1741 was a self-taught artist. He's best known for his six part series of paintings, "The Progress of Human Culture". He completed these for the Great Room of the Royal Society of Arts. He became a member of the Royal Academy in 1773 and taught as a Professor there from 1782 to 1799. Barry was one of the earliest of the "romantic" painters in Britain and although he died in **poverty** in 1806 he was thought to be the most important Irish Neoclassical artist.

Newton 's Law of Cooling by Prof. Subhashish Chattopadhyay SKMClasses Bangalore Useful for IIT-JEE, CBSE, I.Sc. PU-II, Boards, CET, CEE, PET, IGCSE IB AP-Physics and other exams



20) **Joseph Gandy** - Reviews for a 2006 book on the life of Joseph Gandy referred to him as a "stifled genius" and "our greatest architectural artist." But history has mainly forgotten the genius that was Gandy, who lived and worked in Britain in the early 1800s. Despite being a major figure in Romantic culture and creating some of the best architectural drawings of all time, he was a commercial failure and was thrown into debtor's prison. He died in a windowless asylum that his family had him committed to, and the whereabouts of his grave are unknown.

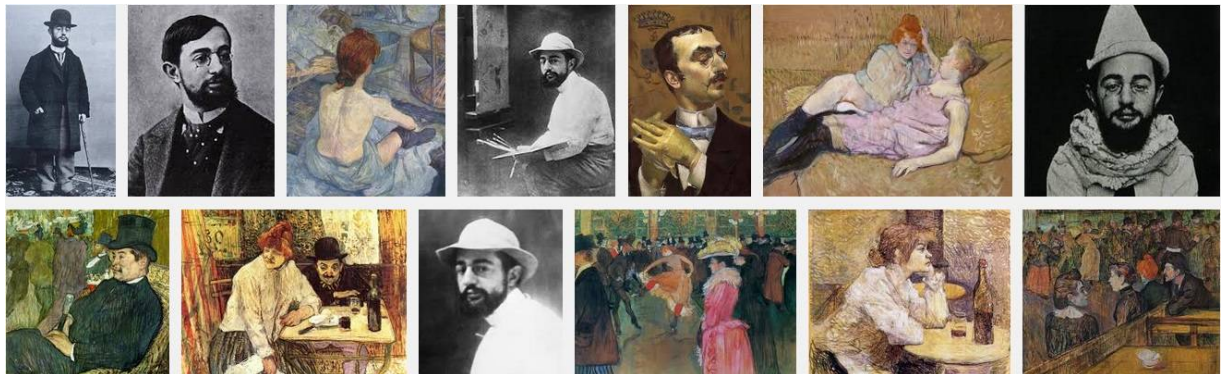

21) **Henri de Toulouse** - Lautrec was born in France in 1864. He was a close friend of Vincent Van Gogh, even using him as a subject for his painting. Toulouse-Lautrec is considered one of the great painters of the Post-Impressionist period. He favored painting the theatrical life of Paris in the 1800's, giving his audiences personal and provocative peeks inside the Moulin Rouge. Unfortunately, Toulouse-Lautrec suffered from a variety of health issues including pycnodysostosis (a disease that causes very short brittle bones). This may have been the culprit that caused his short stature. Depression caused Toulouse-Lautrec to begin drinking and he died in poverty in 1901 from complications of alcoholism as well as syphilis.

Newton 's Law of Cooling by Prof. Subhashish Chattopadhyay SKMClasses Bangalore Useful for IIT-JEE, CBSE, I.Sc. PU-II, Boards, CET, CEE, PET, IGCSE IB AP-Physics and other exams

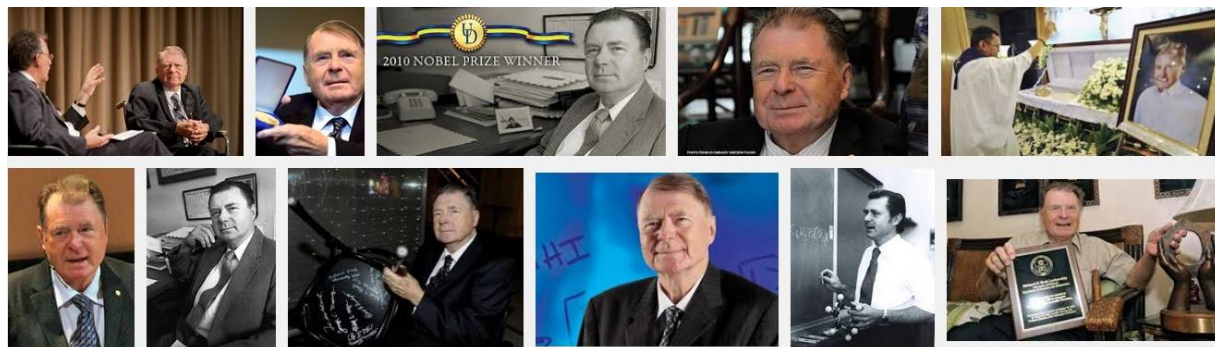

22) **Richard Heck** - 2010 Nobel Chemistry prizewinner died aged 84 in Manila. **He was Penniless**. Famous for his Heck reaction that he discovered in the late 1960s and then spent three decades refining, he won the Nobel for it along with two Japanese chemists working in a similar field.

-



23) **Gustave C. Langenberg** Born in 1859 in Germany this painter became known as "The Painter on Horseback". He painted many portraits including a portrait of Queen Wilhelmina, which hangs even today at the Royal Palace at The Hague. Langenberg fought in the Boer War as a member of the British Army. He painted many battle scenes of his time there. Afterward spending time in Mexico, Langenberg painted Mexican scenes including the Hill Indians and Mexican natives. Although he toured much of the world and spent time with Kings and Queens, he died alone and **penniless** in 1915.

Newton 's Law of Cooling by Prof. Subhashish Chattopadhyay SKMClasses Bangalore Useful for IIT-JEE, CBSE, I.Sc. PU-II, Boards, CET, CEE, PET, IGCSE IB AP-Physics and other exams



24) **Rembrandt Harmenszoon van Rijn Rembrandt** was born in 1606 and he became one of the greatest painters of all time and certainly the most important in Dutch history. Historians credit him with bringing on the "Dutch Golden Age". He was best known for his portraits. Rembrandt also painted many biblical scenes. He was credited with having great empathy into the human condition, which helped him to capture his subjects in a way no one else could seem to manage. Unfortunately his life was fraught with tragedy and after his wife died and his friends deserted him, he was pushed into bankruptcy and unable to find any more work. He died in obscurity and poverty in 1669.



25) **Amedeo Modigliani** - Born in 1884, Modigliani was an Italian artist. He painted and sculpted, spending most of his career in France. He was known for his unique portraits and lush nudes. Modigliani's family was very poor and tragedy followed him from an early age. He was a true bohemian, drinking absinthe, smoking hashish, and attending wild parties. Modigliani lived fast and hard and died of tubercular meningitis at the age of 35, leaving his nine-month pregnant wife behind. She was so distraught over his death she committed suicide the very next day jumping five stories to her death.



26) **Franz Schubert** - Like van Gogh, Schubert was exceptionally prolific in his short life as a classical composer (he died at the age of 31, just one year after the death of his contemporary, Beethoven). Also similarly to van Gogh, Schubert's works were of little interest to those of his age, and considered inferior to Bach and Beethoven. Because of his financial difficulties, Schubert often lead a rather bohemian and at time nomadic lifestyle, but it did not slow down his production. His music influenced later composers such as Brahms and Mendelssohn, and the complexity and beauty of his melodies are now thought to be on par with Mozart (you may recognize one little song of his called "Ave Maria"), solidifying his place in the canon of neglected geniuses who died in obscurity.



27) **William Blake** - William Blake was another artistic luminary working in obscurity in his day. Though he died poor and unknown, he did not have any debts. Blake was one of the first artists of the 18th century to rebel against Rationalism and move forward into the Romantic Age, and was unsurprisingly considered "mad" because of it. At the time of his death Wordsworth wrote of him, "There was no doubt that this poor man was mad, but there is something in the madness of this man which interests me more than the sanity of Lord Byron and Walter Scott." Blake was known not only for his paintings but also for his fantastic engravings that illustrated his poetry. Despite attempts at exhibitions of his works, no interest was attracted at the time, which did not deter (thankfully) Blake from continuing to produce. He was buried in an **unmarked grave** at Bunhill Fields in 1827.

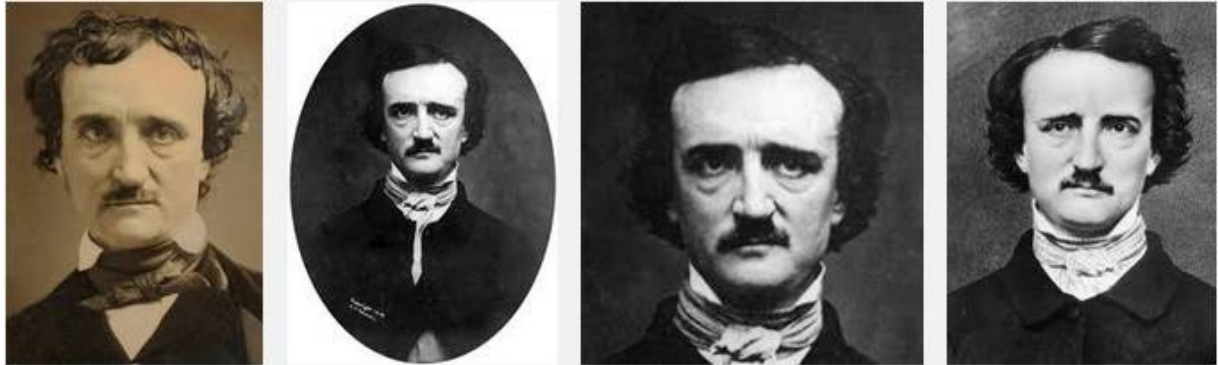

28) **Edgar Allan Poe** - Without a doubt now one of the most recognizable names in literature, Edgar Allen Allan Poe was one of the first writers to attempt to make a living on just that, and unfortunately embodied the Romantic notion of life as a starving artist because of it. Facing a myriad of rejections early in his career, even after Poe was published (in 1839 with a volume of short stories, "Tales of the Grotesque and Arabesque") he initially received no money for his work. Despite the relative success of stories such as "The Gold Bug," **Poe was unable to make enough money to support his family.** Whether attempting to start his own magazines or simply working at journals that ultimately failed, Poe's revenue stream seem to have a life-long curse of bad luck. His beloved wife died in 1847, and two years later Poe was hospitalized and died in utter poverty under famously mysterious circumstances.



29) **Sammy Davis, Jr.** - The famous Rat Pack singer is reported to have made over \$50 million in his lifetime, but died in 1990 \$15 million in debt (much of it, like in the case of Joe Louis, was owed to the IRS). Though he made around \$1 million a year at the height of his career, the notorious "swinging world" of the Rat Pack nearly bankrupted Davis. According to Matt Birkbeck's book "Deconstructing Sammy," Davis actually rejected surgery in 1989 on his throat that may have saved him, because of his dismal finances. He reasoned that without his voice he couldn't sing and therefore couldn't make any more money. Birkbeck spoke to NPR in 2008 to talk about Sammy's regrettable decline from superstardom to poverty.



30) **Antonio Meucci** - At least in the United States, Alexander Graham Bell has enjoyed far more acclaim than Antonio Meucci, whose name likely invokes a resounding "Who?" from most Americans. But in 2002, Congress gave Meucci his just credit for the invention of the telephone, or the "teletrofono" as he had called it. Bell simply called it "mine" when he stole the idea from Meucci 's papers, which he had sent to Bell's company in the hopes of securing financial backing. Meucci sued him but **died, penniless**, in 1889, never having been able to profit from his genius.

See

<http://www.kellenmyers.org/deaths.html>

<http://blog.redbubble.com/2014/02/6-famous-artists-who-died-poor-and-alone/>

http://www.realclearscience.com/blog/2015/02/mathematicians_die_in_horrible_ways.html

<http://www.finearttips.com/2011/10/10-famous-artists-who-died-before-their-art-was-recognized/>

<http://www.therichest.com/rich-list/poorest-list/10-famous-artists-that-died-penniless/>

Did you notice that these great passionate Men, **did not quit** from their work or Passion. They did not switch to some other means of " **making money** " even in abject Poverty! Men are in Love (war) with their Work, Creations, Problems, Research, Search of new Knowledge ...

Kamikaze Pilots can only be Men. Passionate great men doesn't know "how to quit" or simply Can't quit.



Newton 's Law of Cooling by Prof. Subhashish Chattopadhyay SKMClasses Bangalore Useful for IIT-JEE, CBSE, I.Sc. PU-II, Boards, CET, CEE, PET, IGCSE IB AP-Physics and other exams

It is quite expected that, the advice for quitting will come from women ...

<https://www.youtube.com/watch?v=6MBaFL7sCb8>

<https://www.youtube.com/watch?v=wfNX1cHk-fE>

In case of calamity there are broadly "Two Ways" to survive. **Women prefer to runaway**, hide (change jobs / change family / change Protector). This is a very valid way, a very intelligent / safe way, to continue living. **Running away ensures Survival.**

But the Second Way, which most Men Prefer, is to fight it out! It is to "**Solve the Problem**" to survive! This is a very valid way, but bit foolish / unsafe way ! This ensures living. **After the problem is solved it ensures Survival.**

This book is for young students say around the age of 13 to Max 20 years. So to elaborate the above survival techniques, let us see some very simple or common example.

If there is a fire then all **women rush out to extinguish the fire**, risking whatever While Men are hardly seen, as every Man has taken recluse in some far away safe place ...



Am I saying or seeing something wrong ?



Why are the Maths Department of every College, or Every IIT is full with Women ?

99% Women, and rarely 1% Men somehow making it ?

This book is dedicated to Hardworking Men who solve Problems ...

Newton 's Law of Cooling by Prof. Subhashish Chattopadhyay SKMClasses Bangalore Useful for IIT-JEE, CBSE, I.Sc. PU-II, Boards, CET, CEE, PET, IGCSE IB AP-Physics and other exams

Preface

We all know that in the species "Homo Sapiens ", males are bigger than females. The reasons are explained in standard 10, or 11 (high school) Biology texts. **This shapes or size, influences all of our culture.** Before we recall / understand the reasons once again, let us see some random examples of the influence

Random - 1

If there is a Road rage, then who all fight ? (generally ?). Imagine two cars driven by adult drivers. Each car has a woman of similar age as that of the Man. The cars " touch " or " some issue happens" . Who all comes out and fights ? Who all are most probable to drive the cars ?



(Men are eager to fight, eager to rule, eager for war. Men want to drive. Men want to win)

Random - 2

Heavy metal music artists are all Men. Metallica, Black Sabbath, Motley Crue, Megadeth, Motorhead, AC/DC, Deep Purple, Slayer, Guns & Roses, Led Zeppelin, Aerosmith [the list can be in thousands](#). All these are grown-up Boys, known as Men.



(**Men strive for perfection. Men are eager to excel. Men work hard. Men want to win.**)



Newton 's Law of Cooling by Prof. Subhashish Chattopadhyay SKMClasses Bangalore Useful for IIT-JEE, CBSE, I.Sc. PU-II, Boards, CET, CEE, PET, IGCSE IB AP-Physics and other exams

Random - 3

Apart from Marie Curie, only one more woman got Nobel Prize in Physics. (Maria Goeppert Mayer - 1963). So, ... almost all are men.



(**Men want to excel. Men strive for perfection. Men want to win. Men work hard. Men do better than women.**)

Random - 4

The best Tabla Players are all Men.



(**Men want to excel. Men strive for perfection. Men want to win. Men work hard. Men do better than women.**)

Newton 's Law of Cooling by Prof. Subhashish Chattopadhyay SKMClasses Bangalore Useful for IIT-JEE, CBSE, I.Sc. PU-II, Boards, CET, CEE, PET, IGCSE IB AP-Physics and other exams

Newton 's Law of Cooling by Prof. Subhashish Chattopadhyay SKMClasses Bangalore Useful for IIT-JEE, CBSE, I.Sc. PU-II, Boards, CET, CEE, PET, IGCSE IB AP-Physics and other exams

Random - 5

History is all about, [which all Kings ruled](#). Kings, their men, and Soldiers went for wars. [History is all about wars, fights, and killings by men](#). Who won, and who controlled !



Boys start fighting from school days. Girls do not fight like this



([Men are eager to fight, eager to rule, eager for war. Men want to drive. Men want to win.](#))

Newton 's Law of Cooling by Prof. Subhashish Chattopadhyay SKMClasses Bangalore Useful for IIT-JEE, CBSE, I.Sc. PU-II, Boards, CET, CEE, PET, IGCSE IB AP-Physics and other exams

Newton 's Law of Cooling by Prof. Subhashish Chattopadhyay SKMClasses Bangalore Useful for IIT-JEE, CBSE, I.Sc. PU-II, Boards, CET, CEE, PET, IGCSE IB AP-Physics and other exams

Random - 6

The highest award in Mathematics, the " Fields Medal " is around since decades. Till date only one woman could get that. (Maryam Mirzakhani - 2014). So, ... almost all are men.



(Men want to excel. Men strive for perfection. Men want to win. Men work hard. Men do better than women.)

Random - 7

Actor is a gender neutral word. Could the movie like " Top Gun " be made with Female actors ? The best pilots, astronauts, Fighters are all Men.



Newton 's Law of Cooling by Prof. Subhashish Chattopadhyay SKMClasses Bangalore Useful for IIT-JEE, CBSE, I.Sc. PU-II, Boards, CET, CEE, PET, IGCSE IB AP-Physics and other exams

Random - 8

In my childhood had seen a movie named " The Tower in Inferno ". In the movie when the tall tower is in fire, women were being saved first, as only one lift was working....



Many decades later another movie is made. A box office hit. " The Titanic ". In this also As the ship is sinking women are being saved. Men are disposable. Men may get their turn later... (never) !!



Movies are not training programs. Movies do not teach people what to do, or not to do. Movies only reflect the prevalent culture. Men are disposable; is the culture in the society. Knowingly, unknowingly, the culture is depicted in Movies, Theaters, Stories, Poems, Rituals, etc. I or you can't write a story, or make a movie in which after a minor car accident the Male passengers keep seating in the back seat, while the both the women drivers come out of the car and start fighting very bitterly on the road. There has been no story in this world, or no movie made, where after an accident or calamity, Men are being helped for safety first, and women are told to wait.

Newton 's Law of Cooling by Prof. Subhashish Chattopadhyay SKMClasses Bangalore Useful for IIT-JEE, CBSE, I.Sc. PU-II, Boards, CET, CEE, PET, IGCSE IB AP-Physics and other exams

Random - 9

Artists generally follow the prevalent culture of the Society. In paintings, sculptures, stories, poems, movies, cartoon, Caricatures, knowingly / unknowingly, " **the prevalent Reality** " is depicted. **The opposite will not go well with people**. If deliberately " the opposite " is shown then it may only become a special art, considered as a special mockery.

पत्नी (सल्टू से): मुझे नई साड़ी ला दो प्लीज।
 सल्टू : पर तुम्हारी दो-दो अलमारियां साईं डियों से ही तो भरी हैं।
 पत्नी - वह सारी तो पूरे मोहल्ले वालों ने देख रखी हैं।
 सल्टू - तो साड़ी लेने के बजाए मोहल्ला बदल लेते हैं।



Random - 10

Men go to "girl / woman's house" to marry / win, and bring her to his home. That is a sort of winning her. When a boy gets a " Girl-Friend ", generally he and his friends consider that as an achievement. The boy who " got / won " a girl-friend feels proud. His male friends feel, jealous, competitive and envious. Millions of stories have been written on these themes. Lakhs of movies show this. Boys / Men go for " bike race ", or say " Car Race ", where the winner " gets " the most beautiful girl of the college.



(**Men want to excel. Men are eager to fight, eager to rule, eager for war. Men want to drive. Men want to win.**)

Prithviraj Chauhan ' went ` to " pickup " or " abduct " or " win " or " bring " his love. There was a Hindi movie (hit) song ... " Pasand ho jaye, to ghar se utha laye ". It is not other way round. Girls do not go to Boy's house or man's house to marry. Nor the girls go in a gang to " pick-up " the boy / man and bring him to their home / place / den.

Newton 's Law of Cooling by Prof. Subhashish Chattopadhyay SKMClasses Bangalore Useful for IIT-JEE, CBSE, I.Sc. PU-II, Boards, CET, CEE, PET, IGCSE IB AP-Physics and other exams

Newton 's Law of Cooling by Prof. Subhashish Chattopadhyay SKMClasses Bangalore Useful for IIT-JEE, CBSE, I.Sc. PU-II, Boards, CET, CEE, PET, IGCSE IB AP-Physics and other exams

Random - 11

We have the word "ice cold". While, when it snows heavily, the cleaning of the roads is done by Men. Ice avalanche is cleared by Guns, by Men.



Can women do this please ?



Random - 12



Newton 's Law of Cooling by Prof. Subhashish Chattopadhyay SKMClasses Bangalore Useful for IIT-JEE, CBSE, I.Sc. PU-II, Boards, CET, CEE, PET, IGCSE IB AP-Physics and other exams

Newton 's Law of Cooling by Prof. Subhashish Chattopadhyay SKMClasses Bangalore Useful for IIT-JEE, CBSE, I.Sc. PU-II, Boards, CET, CEE, PET, IGCSE IB AP-Physics and other exams



There are many remote mines in this world which are connected by rails through Hilly regions. These railroads move through steep ups and downs. Optimum speed of the train has to be maintained !! The expert driver has to ensure that the brakes do not burn out, if driven too slow. The speed should be enough so that next climbing can be done. Sudden braking is not possible ! ; as the load of the wagons will derail the train, and that will mean huge loss and deaths. The **Drivers are Men who risk their lives in every journey.**



Newton 's Law of Cooling by Prof. Subhashish Chattopadhyay SKMClasses Bangalore Useful for IIT-JEE, CBSE, I.Sc. PU-II, Boards, CET, CEE, PET, IGCSE IB AP-Physics and other exams

Newton 's Law of Cooling by Prof. Subhashish Chattopadhyay SKMClasses Bangalore Useful for IIT-JEE, CBSE, I.Sc. PU-II, Boards, CET, CEE, PET, IGCSE IB AP-Physics and other exams



Fukushima Daiichi nuclear disaster happened on March 11, 2011. This was primarily by the tsunami following the Tōhoku earthquake (magnitude 9.0). Lots of radioactive materials were scattered in the environment through “vent” to reduce the internal pressure and the hydroponic explosions of the nuclear reactors.

Old Men, Pensioners, Seniors offered to cleanup the Nuclear damage as '**suicide corps**' See <http://edition.cnn.com/2011/WORLD/asiapcf/05/31/japan.nuclear.suicide/>

Old People Line Up To Clean Radiation in Japan



kelly
5/31/11 10:00pm - Filed to: JAPAN



I deeply appreciate such gesture to "Save" the society. While I wish to draw your attention to a much deeper/important questions !!

Why old women did not Volunteer to clean the Nuclear site ?

Newton 's Law of Cooling by Prof. Subhashish Chattopadhyay SKMClasses Bangalore Useful for IIT-JEE, CBSE, I.Sc. PU-II, Boards, CET, CEE, PET, IGCSE IB AP-Physics and other exams

Newton 's Law of Cooling by Prof. Subhashish Chattopadhyay SKMClasses Bangalore Useful for IIT-JEE, CBSE, I.Sc. PU-II, Boards, CET, CEE, PET, IGCSE IB AP-Physics and other exams

Old women are not pregnant ! Women get menopause sometime in their early 40s. Why is it so common in the Society to "Save" older women as well, and "spare" or "deprive" old men ?
Why old men are treated so badly ? Why are Men eager to fight every war ?

[Climbing Everest or any Mountain Peak, or say crossing Atlantic solo, or reaching the North Pole / South Pole; Almost ALL are Men isn't it Researching into technology, inventing and discovering new frontiers of Science is also a war! In every case it is **Almost ALL Men**]

Very Sad, bad habit of Million years, is driving the world for so much of "Good" and "BAD" !

The reader / student should not assume that I have not read enough Philosophy; where it is taught that GOOD or BAD are only individual's mental interpretations. I am mature enough to say the above words as ' Million years of Good Habit of **"Fighting to Win and Survive"** has led Men to all sorts of difficulties, accidents, discomforts, loss '

Most women are just Thankless to Men, and their efforts. Women just use Men like parasite or Leeches. They see all the facilities' and benefits as their right !

(Unfortunately most men submit themselves to be used / exploited like this ! MGTOW s are one of the exceptions.)

In all countries the Laws / Traditions / Customs / Society norms etc have been systematically twisted in favor of women to ensure that Women get "everything". While Nothing is available for Men !



For example Money, Job, Certificate, Facilities etc are given to Widow and (may be Mom) of the deceased MAN; who died 'fighting' ! The Law or norm is not for the father of the Soldier. [Think ... who is dying ? Who is surviving ? Who is getting the benefits ? who is being deprived ?]

(These images are a few amongst Millions of images which are available. All make the same point)

Newton 's Law of Cooling by Prof. Subhashish Chattopadhyay SKMClasses Bangalore Useful for IIT-JEE, CBSE, I.Sc. PU-II, Boards, CET, CEE, PET, IGCSE IB AP-Physics and other exams

Newton 's Law of Cooling by Prof. Subhashish Chattopadhyay SKMClasses Bangalore Useful for IIT-JEE, CBSE, I.Sc. PU-II, Boards, CET, CEE, PET, IGCSE IB AP-Physics and other exams



Home > India > India News > Paternity leave will be just a holiday for men, says Maneka Gandhi

Paternity leave will be just a holiday for men, says Maneka Gandhi

The legislation would mean that India would join the ranks of Eastern European and Nordic countries that have the longest fully paid maternity leave.

88.8K
SHARES



Written by **Shalini Nair** | New Delhi | Updated: August 25, 2016 10:50 am



Men are only for working ! (sorry, hunting!) always ... that's what most people think !

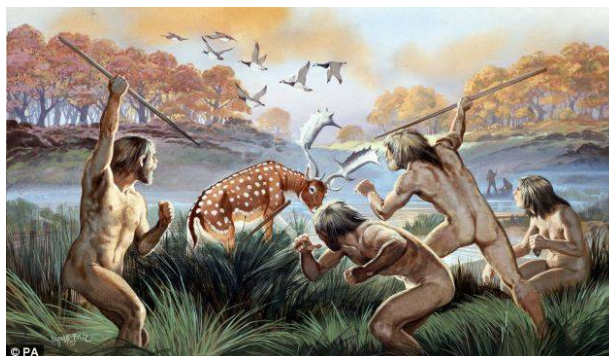
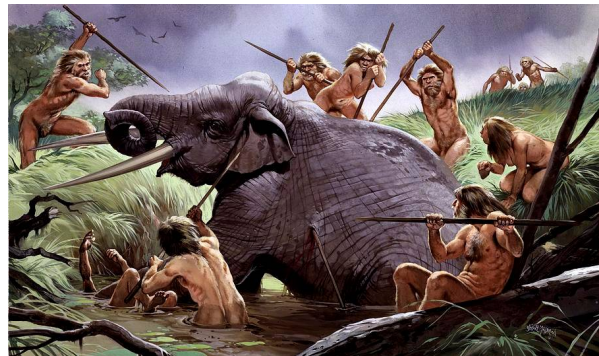

Newton 's Law of Cooling by Prof. Subhashish Chattopadhyay SKMClasses Bangalore Useful for IIT-JEE, CBSE, I.Sc. PU-II, Boards, CET, CEE, PET, IGCSE IB AP-Physics and other exams

Newton 's Law of Cooling by Prof. Subhashish Chattopadhyay SKMClasses Bangalore Useful for IIT-JEE, CBSE, I.Sc. PU-II, Boards, CET, CEE, PET, IGCSE IB AP-Physics and other exams

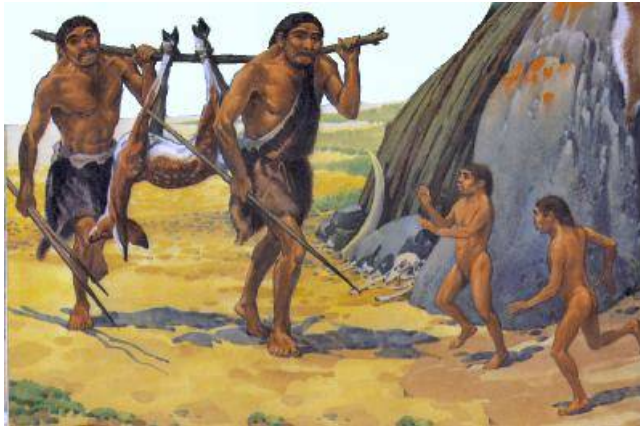

Every woman has a womb. The women (rather their Wombs) were protected / kept safe, so that children are born. That was the survival method to continue the species...

Let us name the best of the Mathematicians ...

Leonhard Euler, Isaac Newton, Carl Gauss, Fermat, Henri Poincaré, Lagrange, David Hilbert, G.W. Leibniz ...

(See <http://fabpedigree.com/james/mathmen.htm>)

Why all these great names are of Men ? Why women could not contribute, in the cozy safe home ?

A newly married couple goes out in car ... and if there is a flat tire (known as puncture in India) then who opens the wheels ? who replaces from the stepney ?



Womb being protected ? Why women don't help ?

How much is the Society or Men paying for wombs ? This penance is till which age ?

Newton 's Law of Cooling by Prof. Subhashish Chattopadhyay SKMClasses Bangalore Useful for IIT-JEE, CBSE, I.Sc. PU-II, Boards, CET, CEE, PET, IGCSE IB AP-Physics and other exams

People in the domestic violence field say that 'it's all about the victims.' Well, most of the times, the victim is the one arrested. Current laws are pure misandry.

Domestic violence facts:

- Women are far more likely to instigate violence
- In non reciprocal violence, in 70% cases, Women are the agressors
- In reciprocal violence, Women tend to hit first
- Women are more likely to physically abuse or kill their children



Sources: - Daniel Whitaker, Ph.D., et al., American Journal of Public Health, May 2007
 - Journal Partner Abuse, an unparalleled three-year research project, conducted by 42 scholars at 20 universities and research centers, and including information on 17 areas of domestic violence research - John Hamel, LCSW Editor-in-Chief
 - <http://www.domesticviolenceresearch.org>

STOP MALE BLAMING ! STOP THE FEMINIST LIES !
Domestic Violence is NOT gender based and is NOT violence against Women !

No woman works for " Male Suicide " issues. Even-though, the rate of suicide in men are many times higher, than that of women. Women are never bothered about Men. Some women work only for "women issues " .



"It's so cool! If you use your imagination, you can blame men for *everything!*"

Newton 's Law of Cooling by Prof. Subhashish Chattopadhyay SKMClasses Bangalore Useful for IIT-JEE, CBSE, I.Sc. PU-II, Boards, CET, CEE, PET, IGCSE IB AP-Physics and other exams

<http://www.telegraph.co.uk/men/the-filter/11965029/Middle-aged-male-suicide-rate-rises-by-40-per-cent-since-2008.html>

<http://scroll.in/article/669061/married-men-are-most-likely-to-commit-suicide-in-india>



Texas woman who fatally shot her two daughters on her husband's birthday "wanted him to suffer"

- Yes, mental illness was involved
- Yes, many women commit Domestic Violence
- Yes, this is an extreme case. However, many are vindictive and will use their own children against a former partner in countless other ways, over the course of many years of the child's life
- Yes, many look and act *normal* in everyday life
- Yes, too many Judges believe their theatrics

"Happy Daughter's Day to my amazing, sweet, kind, beautiful, intelligent girls. I love and treasure you both more than you could ever possibly know." -Christy Sheats

The Fathers' Rights Movement
facebook.com/fathers4ids

- Yes, fathers often stay to protect their children
- Yes, fathers face an unfair uphill battle in Family Law
- Yes, Family Law MUST be Reformed!

Meet the Woman Who Shot Her Son with the Same Gun She Used to Kill Her Husband 20 Years Earlier

By **Afarin Majidi** - August 3, 2015

Share on Facebook | Tweet on Twitter | Like B15 | Tweet



1. Katherine Knight – Kills Husband and Eats Him.



This lady, Katherine Knight stabbed his poor husband 37 times with a butcher's knife then skinning him and hanged his body with a meat hook in their lounge room. Katherine, the first Australian woman to be sentenced to a natural life term without parole. She had a history of violence in relationships. She mashed the dentures of one of her ex-husbands and slashed the throat of another husband's eight-week-old puppy before his eyes. A heated relationship with John Charles

3. Stacey Castor, poisoned husband with antifreeze and then framed her daughter.

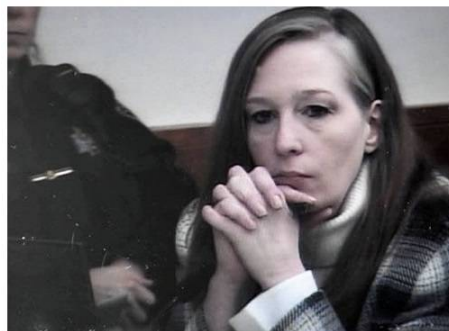

Stacy Castor staged a scene to make her dead husband appeared to have committed suicide but getting the cops suspicious then investigated her past only to found out that her former husband was dead from a 'heart attack' . suspicios, the cops enquire an autopsy of the former husband and found ethylene glycol substance same like the second husband's autopsy.

10. The woman who cheated on her husband after he had donated his own kidney to her.



4. Omaira Aree Nelson, Killed, Chopped Up, Cooked and Ate Husband.



Model Omaira Aree Nelson tried to grind her husband up in the garbage disposal. But she just couldn't get rid of all of 6-foot-4, 230 lbs. of him so she boiled, breaded, deep-fried and ate body parts. (Link).

Newton 's Law of Cooling by Prof. Subhashish Chattopadhyay SKMClasses Bangalore Useful for IIT-JEE, CBSE, I.Sc. PU-II, Boards, CET, CEE, PET, IGCSE IB AP-Physics and other exams

Newton 's Law of Cooling by Prof. Subhashish Chattopadhyay SKMClasses Bangalore Useful for IIT-JEE, CBSE, I.Sc. PU-II, Boards, CET, CEE, PET, IGCSE IB AP-Physics and other exams

5. Angry Wife Cuts Off Husband's Balls While He is Sleeping.



An angry Chinese woman in Xiaoxian, Jiangxi province, China, sliced off her husband's testicles while he was sleeping, in order to protect her marriage.

8. 76-year-old lady who is suspected of murdering four of her five husbands.



Jeff Carstensen was spooked when he learned his grandmother planned to buy him a \$100,000 life insurance policy – and name herself the beneficiary. As he and many others who came into Betty Neumar's orbit have learned, bad things tend to happen to the people around her.

Human beings are in general not comfortable with New ideas or New Paradigms or say new doctrines. New ideas take time to shape up !

(I am aware of Hundredth monkey effect ... scientists were conducting a study of macaque monkeys on the Japanese island of Koshima in 1952. These scientists observed that some of these monkeys learned to wash sweet potatoes, and gradually this new behavior spread through the younger generation of monkeys—in the usual fashion, through observation and repetition. Watson then concluded that the researchers observed that once a critical number of monkeys was reached, i.e., the hundredth monkey, this previously learned behavior instantly spread across the water to monkeys on nearby islands.

https://en.wikipedia.org/wiki/Hundredth_monkey_effect)

<http://www.dailymail.co.uk/sciencetech/article-3317316/Monkeys-food-hygiene-Macaques-clean-potatoes-grain-eating-fewer-parasites.html>

Robindranath Thakur, the first Nobel Laureate of Asia, was follower / believer of Bromho. His father Debendranath Thakur, (As son of Dwarkanath Tagore, a close friend of Ram Mohan Roy) philosopher and religious reformer, active in the Brahmo Samaj ("Society of Brahmā," also translated as "Society of God"), which aimed to reform the Hindu religion and way of life. He was one of the founders in 1848 of the Brahmo religion, which today is synonymous with Brahmoism.

When Robindronath wanted to open a school in Calcutta, **many people did not want to send their children to a "Bromho Teacher "**. So In 1901 Tagore moved to Santiniketan to found an ashram.

Newton 's Law of Cooling by Prof. Subhashish Chattopadhyay SKMClasses Bangalore Useful for IIT-JEE, CBSE, I.Sc. PU-II, Boards, CET, CEE, PET, IGCSE IB AP-Physics and other exams

Newton 's Law of Cooling by Prof. Subhashish Chattopadhyay SKMClasses Bangalore Useful for IIT-JEE, CBSE, I.Sc. PU-II, Boards, CET, CEE, PET, IGCSE IB AP-Physics and other exams



Chatimtala Kaanch Ghor the Bramho Mandir, at Santiniketan

[English People could not pronounce Thakur. They used to distort it as Tagore Over time the family name is called as Tagore by most non-Bengalis]



Abdus Salam the only Physics Nobel Laureate of Pakistan was an Ahmadiyya; by faith. Ahmadiyya religion is not accepted in Pakistan. [[The theological amendment in the constitution of Pakistan does not allow members of the Ahmadiyya faith to call themselves Muslims.](#)] Abdus Salam had to shift to Trieste, Italy. Salam was buried in Bahishti Maqbara, a cemetery established by the Ahmadiyya Community at Rabwah, Punjab, Pakistan, next to his parents' graves. The epitaph on his tomb initially read "**First Muslim Nobel Laureate**". The Pakistani government removed "Muslim" and left only his name on the headstone. The word "Muslim" was initially obscured on the orders of a local magistrate before moving to the national level.

Newton 's Law of Cooling by Prof. Subhashish Chattopadhyay SKMClasses Bangalore Useful for IIT-JEE, CBSE, I.Sc. PU-II, Boards, CET, CEE, PET, IGCSE IB AP-Physics and other exams

Newton 's Law of Cooling by Prof. Subhashish Chattopadhyay SKMClasses Bangalore Useful for IIT-JEE, CBSE, I.Sc. PU-II, Boards, CET, CEE, PET, IGCSE IB AP-Physics and other exams

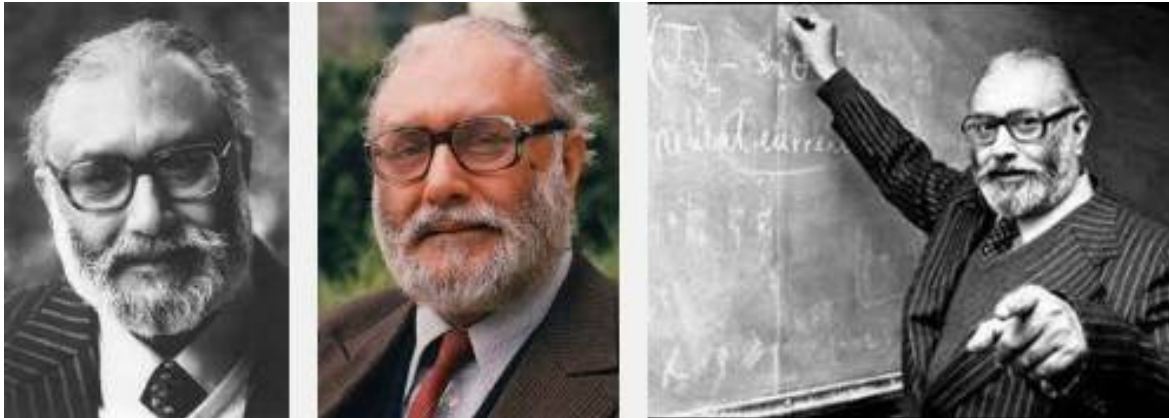

<http://blogs.tribune.com.pk/story/19695/we-are-sorry-dr-abdus-salam/>

<http://blogs.tribune.com.pk/story/31969/dr-abdus-salam-and-all-the-wrong-choices-pakistan-made/>

http://www.nobelprize.org/nobel_prizes/physics/laureates/1979/salam-bio.html

In some cases accepting the Truth takes very long time....

Pope John Paul II apologised on behalf of the Catholic Church for the mistreatment of Galileo in the 17th century. The dispute between the Church and Galileo has long stood as one of history's great emblems of conflict between reason and dogma, science and faith. At the time of his condemnation, Galileo had won fame and the patronage of leading Italian powers like the Medicis and Barberinis for discoveries he had made with the astronomical telescope he had built. But when his observations led him to proof of the Copernican theory of the solar system, in which the sun and not the earth is the center, and which the Church regarded as heresy, Galileo was summoned to Rome by the Inquisition. **Forced to Recant.** Galileo took back his statement, but still lived under house arrest for the rest of his life. It took 359 years and the leadership of Pope John Paul II (left) to recognize the wrong. On October 31, 1992, he formally apologized for the "Galileo Case" in the first of many famous apologies during his papacy.

<https://www.youtube.com/watch?v=JUAsLcFPeNw>

History of Gravity ...

Galileo to Einstein https://www.youtube.com/watch?v=2H_zvoENNxo

<https://www.youtube.com/watch?v=OGQq2aB3cWE>

<https://www.youtube.com/watch?v=mPxwgyJtJXI>

Newton 's Law of Cooling by Prof. Subhashish Chattopadhyay SKMClasses Bangalore Useful for IIT-JEE, CBSE, I.Sc. PU-II, Boards, CET, CEE, PET, IGCSE IB AP-Physics and other exams

The New York Times

World

WORLD	U.S.	N.Y. / REGION	BUSINESS	TECHNOLOGY	SCIENCE	HEALTH	SPORTS	OPINION
AFRICA	AMERICAS	ASIA PACIFIC	EUROPE	MIDDLE EAST				

After 350 Years, Vatican Says Galileo Was Right: It Moves

By ALAN COWELL.
Published: October 31, 1992

ROME, Oct. 30— More than 350 years after the Roman Catholic Church condemned Galileo, Pope John Paul II is poised to rectify one of the Church's most infamous wrongs -- the persecution of the Italian astronomer and physicist for proving the Earth moves around the Sun.

With a formal statement at the Pontifical Academy of Sciences on Saturday, Vatican officials said the Pope will formally close a 13-year investigation into the Church's condemnation of Galileo in 1633. The condemnation, which forced the astronomer and physicist to recant his discoveries, led to Galileo's house arrest for eight years before his death in 1642 at the age of 77.

The dispute between the Church and Galileo has long stood as one of history's great emblems of conflict between reason and dogma, science and faith. The Vatican's formal acknowledgement of an error, moreover, is a rarity in an institution built over centuries on the belief that the Church is the final arbiter in matters of faith.

<http://www.nytimes.com/1992/10/31/world/after-350-years-vatican-says-galileo-was-right-it-moves.html>

For new ideas See ...

http://www.slate.com/articles/news_and_politics/foreigners/2009/06/the_herbivores_dilemma.html

<http://www.wisedup.org/antiphysical-men-giving-sex-relationships/>

<https://pairedlife.com/dating/Dating-10-Things-Men-Dont-Do-Anymore>

Newton 's Law of Cooling by Prof. Subhashish Chattopadhyay SKMClasses Bangalore Useful for IIT-JEE, CBSE, I.Sc. PU-II, Boards, CET, CEE, PET, IGCSE IB AP-Physics and other exams

Random - 13 (will you be comfortable with new ideas ?)

Almost all of us are very biased. Instead of I asking some questions; see the following images



<http://www.independent.co.uk/life-style/love-sex/women-are-genetically-programmed-to-have-affairs-evolution-university-texas-scientists-suggest-a7203501.html>



In all cultures the onus of Proving himself not guilty, lies on the Man; while it is enough for the woman just to accuse, and cry. Tears are taken as proof of Crime !

Newton 's Law of Cooling by Prof. Subhashish Chattopadhyay SKMClasses Bangalore Useful for IIT-JEE, CBSE, I.Sc. PU-II, Boards, CET, CEE, PET, IGCSE IB AP-Physics and other exams



**All women are born
evil. Some just realize
their potential later in
life than others.**

QUOTEHD.COM

Chad A. Gamble

Newton 's Law of Cooling by Prof. Subhashish Chattopadhyay SKMClasses Bangalore Useful for IIT-JEE, CBSE, I.Sc. PU-II, Boards, CET, CEE, PET, IGCSE IB AP-Physics and other exams

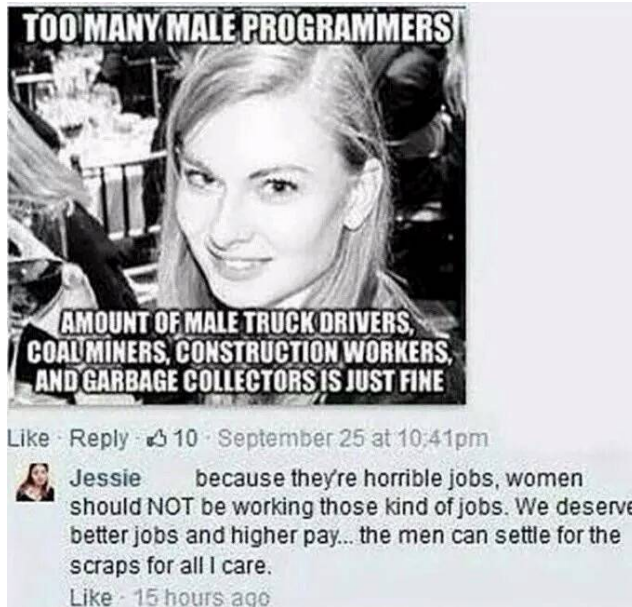

Proof that girls are evil

First we state that girls require time and money.

$$\text{GIRLS} = \text{TIME} \times \text{MONEY}$$

And as we all know "time is money"

$$\text{TIME} = \text{MONEY}$$

Therefore:

$$\text{GIRLS} = \text{MONEY} \times \text{MONEY} = (\text{MONEY})^2$$

And because "money is the root of all evil":

$$\text{MONEY} = \sqrt{\text{EVIL}}$$

Therefore:

$$\text{GIRLS} = (\sqrt{\text{EVIL}})^2$$

We are forced to conclude that:

$$\text{GIRLS} = \text{EVIL}$$

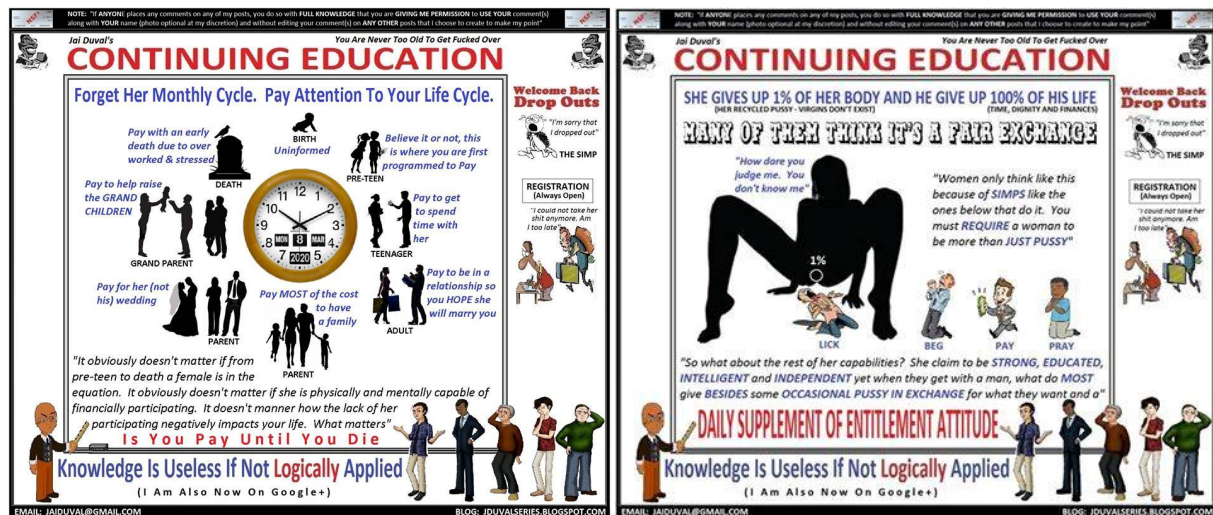

Newton 's Law of Cooling by Prof. Subhashish Chattopadhyay SKMClasses Bangalore Useful for IIT-JEE, CBSE, I.Sc. PU-II, Boards, CET, CEE, PET, IGCSE IB AP-Physics and other exams

Random - 14

Rich people; often are very hard working. Successful business men, establish their business (empire), amass lot of wealth, with lot of difficulty. Lots of sacrifice, lots of hard work, gets into this. **Rich people's wives had no contribution in this wealth creation**. Women are smart, and successful upto the extent to choose the right/rich man to marry. So generally what happens in case of Divorces ? Search the net on " most costly divorces " and you will know. The women;(who had no contribution at all, in setting up the business / empire), often gets in Billions, or several Millions in divorce settlements. [[Just because the wife has womb](#)]

Number 1

Rupert & Anna Murdoch -- \$1.7 billion

One of the richest men in the world, **Rupert Murdoch** developed his worldwide media empire when he inherited his father's Australian newspaper in 1952. He married Anna Murdoch in the '60s and they remained together for 32 years, springing off three children.

They split amicably in 1998 but soon Rupert forced Anna off the board of News Corp and the gloves came off. The divorce was finalized in June 1999 when Rupert agreed to let his ex-wife leave with \$1.7 billion worth of his assets, \$110 million of it in cash. Seventeen days later, Rupert married Wendi Deng, one of his employees.



Ted Danson & Casey Coates -- \$30 million

Ted Danson's claim to fame is undoubtedly his decade-long stint as Sam Malone on NBC's celebrated sitcom Cheers . While he did other TV shows and movies, he will always be known as the bartender of that place where everybody knows your name. He met his future first bride Casey, a designer, in 1976 while doing Erhard Seminars Training.

Ten years his senior, she suffered a paralyzing stroke while giving birth to their first child in 1979. In order to nurse her back to health, Danson took a break from acting for six months. But after two children and 15 years of marriage, the infatuation fell to pieces. Danson had started seeing Whoopi Goldberg while filming the comedy, Made in America and this precipitated the 1992 divorce. Casey got \$30 million for her trouble.

See <https://zookeepersblog.wordpress.com/misandry-and-men-issues-a-short-summary-at-single-place/>

See <http://skmclasses.kinja.com/save-the-male-1761788732>

It was Boys and Men, who brought the girls / women home. The Laws are biased, completely favoring women. The men are paying for their own mistakes.

See <https://zookeepersblog.wordpress.com/biased-laws/>

(Man brings the Woman home. When she leaves, takes away her share of big fortune!)

<http://www.uplifting-love.com/2013/08/80-percent-of-divorces-are-filed-by.html>

Random - 15

A standardized test of Intelligence will never be possible. It never happened before, nor ever will happen in future. No IQ test results will be acceptable by all. **In the net there are thousands of charts which show that the intelligence scores of girls / women are lesser.** Debates of Trillion words, does not improve performance of Girls.

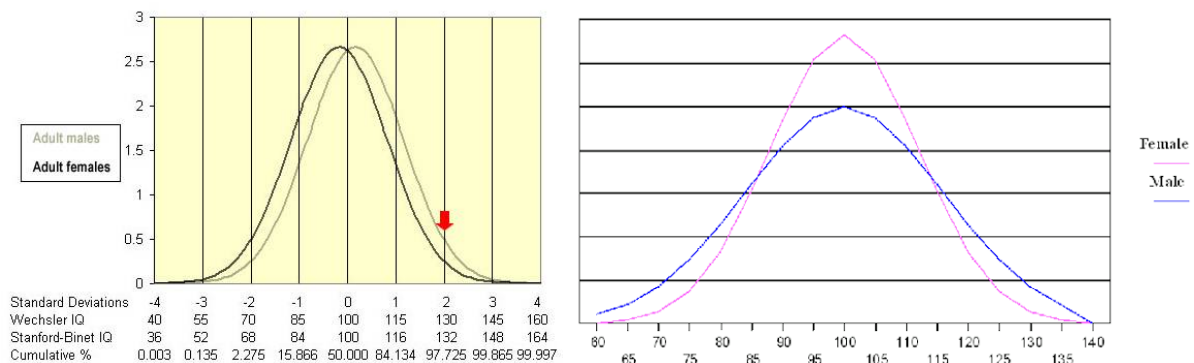

I am not wasting a single second debating or discussing with anyone, on this. **I am simply accepting ALL the results.** IQ is only one of the variables which is required for success in life. Thousands of books have been written on " Networking Skills ", EQ (Emotional Quotient), Drive, Dedication, Focus, " Tenacity towards the end goal " ... etc. **In each criteria, and in all together, women (in general) do far worse than men.** Bangalore is known as " capital of India ". [Fill in the blanks]. The blanks are generally filled as " Software Capital ", " IT Capital ", " Startup Capital ", etc. I am member in several startup eco-systems / groups.

I have attended hundreds of meetings, regarding " technology startups ", or " idea startups ". These meetings have very few women. (Generally in most meetings there are no women at all !). Starting up new companies are all " **Men's Game** " / " **Men's business** ". Only in Divorce settlements women will take their goodies, due to Biased laws. **There is no dedication, towards wealth creation, by women.** Women want easy money.



Max Roscoe

is an aspiring philosopher king, living the dream, travelling the world, hoarding FRNs and ignoring Americans. He is a European at heart, lover of Latinas, and currently residing in the USA.

July 8, 2016

Culture

Women Who Sell Their Bodies For Money Don't Want To Be Called Prostitutes



Random - 16

Many men, as fathers, very unfortunately treat their daughters as " Princess ". Every " non-performing " woman / wife was " princess daughter " of some loving father. Pampering the girls, in name of " equal opportunity ", or " women empowerment ", have led to nothing.



See <http://skmclasses.kinja.com/progressively-daughters-become-monsters-1764484338>

See <http://skmclasses.kinja.com/vivacious-vixens-1764483974>

There can be thousands of more such random examples, where " Bigger Shape / size " of males have influenced our culture, our Society. Let us recall the reasons, that we already learned in standard 10 - 11, Biology text Books. In humans, women have a long gestation period, and also spends many years (almost a decade) to grow, nourish, and stabilize the child. (Million years of habit) Due to survival instinct Males want to inseminate. Boys and Men fight for the " facility (of womb + care) " the girl / woman may provide. Bigger size for males, has a winning advantage. Whoever wins, gets the " woman / womb / facility ". **The male who is of " Bigger Size ", has an advantage to win....** Leading to Natural selection over millions of years. In general " Bigger Males "; the " fighting instinct " in men; have led to wars, and solving tough problems (Mathematics, Physics, Technology, startups of new businesses, Wealth creation, Unreasonable attempts to make things [such as planes / Flying Machines], Hard work)

So let us see the IIT-JEE results of girls. Statistics of several years show that there are around 17, (or less than 20) girls in top 1000 ranks, at all India level. Some people will yet not understand the performance, till it is said that ... **year after year we have around 980 boys in top 1000 ranks.** Generally we see only 4 to 5 girls in top 500. **In last 50 years not once any girl topped in IIT-JEE advanced.** Forget about Single digit ranks, double digit ranks by girls have been extremely rare. It is all about " good boys ", " hard working ", " focused ", "**Bel-esprit** " boys.

Newton 's Law of Cooling by Prof. Subhashish Chattopadhyay SKMClasses Bangalore Useful for IIT-JEE, CBSE, I.Sc. PU-II, Boards, CET, CEE, PET, IGCSE IB AP-Physics and other exams

In 2015, Only 2.6% of total candidates who qualified are girls (upto around 12,000 rank). while 20% of the Boys, amongst all candidates qualified. The Total number of students who appeared for the exam were around 1.4 million for IIT-JEE main. Subsequently 1.2 lakh (around 120 thousands) appeared for IIT-JEE advanced.

IIT-JEE results and analysis, of many years is given at

<https://zookeepersblog.wordpress.com/iit-jee-iseet-main-and-advanced-results/>

In Bangalore it is rare to see a girl with rank better than 1000 in IIT-JEE advanced. We hardly see 6-7 boys with rank better than 1000. Hardly 2-3 boys get a rank better than 500.

See <http://skmclasses.weebly.com/everybody-knows-so-you-should-also-know.html>

So what " some women " are doing ?

Thousands of people are exposing the heinous crimes that Motherly Women are doing, or Female Teachers are committing. See <https://www.facebook.com/WomenCriminals/>

Some Random Examples must be known by all

It is extremely unfortunate that the " woman empowerment " has created. This is the kind of society and women we have now. I and many other sensible Men hate such women. Be away from such women, be aware of reality.



Mother Admits On Facebook to Sleeping with 15 Yr Old Son, They Have a Baby Together - Alwayzturmtup

Sometimes it hard to believe w From Alwayzturmtup

ALWAYZTURNUP.ME



'Sex with my son is incredible - we're in love and we want a baby'

Ben Ford, who ditched his wife when he met his mother Kim West after 30 years, claims what the couple are doing isn't incest

MIRROR.CO.UK

Newton 's Law of Cooling by Prof. Subhashish Chattopadhyay SKMClasses Bangalore Useful for IIT-JEE, CBSE, I.Sc. PU-II, Boards, CET, CEE, PET, IGCSE IB AP-Physics and other exams

Newton 's Law of Cooling by Prof. Subhashish Chattopadhyay SKMClasses Bangalore Useful for IIT-JEE, CBSE, I.Sc. PU-II, Boards, CET, CEE, PET, IGCSE IB AP-Physics and other exams

Woman sent to jail for the rest of her life after raping her four grandchildren is described as the 'most evil person' the judge has ever seen

Edwina Louis rape...

See More



Former Shelbyville ISD teacher who had sex with underage student gets 3 years in prison

After a two day break over the weekend, A Shelby County jury was back in the courtroom looking to conclude the trial of a former Shelbyville ISD teacher who had...

KLTV.COM | BY CALEB BEAMES

<http://www.thenativecanadian.com/.../eastern-ontario-teacher-...>



Woman sent to jail for raping her four grandchildren

A Ohio grandmother has been sentenced to four consecutive life terms after being found guilty of the rape of her own grandchildren. Edwina Louis, 53, will spend the rest of her life behind bars.

DAILYMAIL.CO.UK



The N.C. Chronicles.: Eastern Ontario teacher charged with 36 sexual offences

anti feminism, Child abuse, children's rights, Feminist hypocrisy,

THENATIVECANADIAN.COM | BY BLACKWOLF



Hyd woman kills newborn boy as she wanted daughter - Times of India

Having failed to bear a daughter for the third time, a shopkeeper's wife slit the throat of her 24day-old son with a shaving blade and left him to die in a street on Tuesday night.Pumima's first child was a stillborn boy, followed by another boy born five years ago.

TIMESOFINDIA.INDIATIMES.COM

Newton 's Law of Cooling by Prof. Subhashish Chattopadhyay SKMClasses Bangalore Useful for IIT-JEE, CBSE, I.Sc. PU-II, Boards, CET, CEE, PET, IGCSE IB AP-Physics and other exams

Newton 's Law of Cooling by Prof. Subhashish Chattopadhyay SKMClasses Bangalore Useful for IIT-JEE, CBSE, I.Sc. PU-II, Boards, CET, CEE, PET, IGCSE IB AP-Physics and other exams

Montgomery's son, Alan Vonn Webb, took the stand and was a key witness in her conviction.

"I want to see her placed somewhere she can never do that to children

....

See More



Woman sentenced to 40 years in prison for raping her children

A Murfreesboro mother found guilty of raping her own children learned her fate on Wednesday.

WAFF.COM | BY DENNIS FERRIER

gentler sex? Violence against men.'s photo.



Up to 64,000 women in UK are child-sex offenders

~ The Guardian

Women, the gentler sex? Violence against men.

April 8 at 1:38am · 🌐

Like Page

In fact, the past decade has seen a dramatic increase in the number of incidents of women raping and sexually assaulting boys and men. On May 2014, Jezebel repo...

In Facebook, and internet + whatsapp etc we have unending number of posts describing frustration of men / husbands on naughty unreasonable women. **Most women are very illogical, Punic, perfidious, treacherous, naughty, gamey bitches.**

We also see zillions of Jokes which basically describe how unreasonable women / girls are. How stupid they are, making life of Boys / Men / Husband a hell.

While each of these girls was someones daughter. Millions of foolish Dads are into Fathers rights movement, who want their daughter back for pampering.

Most girls are being cockered, coddled, cosseted, mollycoddled, featherbedded, spoilt into brats.

Foolish fathers are breeding Monsters who are filing false rape cases. Enacting Biased Laws. Filing False domestic violence cases. Filing false sexual assault cases. Asking for alimony, and taking custody of the Daughter, not allowing the " monster " to meet dad. The cycle goes on and on and on.

Foolish men keep pampering future demons who make other Men's life a hell. (Now read this again from beginning). Every day we see the same posts of frustration.

Newton 's Law of Cooling by Prof. Subhashish Chattopadhyay SKMClasses Bangalore Useful for IIT-JEE, CBSE, I.Sc. PU-II, Boards, CET, CEE, PET, IGCSE IB AP-Physics and other exams



**When I grow up
I will beat my
husband
No one will care
No one will stop me**



October is Domestic
Violence Awareness Month

**53% of Domestic Violence
Victims are Men
Stop the Silence
Stop the Violence**



FUNNY.

NOT FUNNY.

**DOUBLE STANDARDS HURT
EVERYONE.**

<https://nicewomen.wordpress.com/>

Each women as described below was someone's Pampered Princess ...

End violence against women



**North Carolina Grandma Eats Her Daughter's New Born
Baby After Smoking Bath Salts**

Henderson, North Carolina—A North Carolina grandmother of 4 and recovering drug addict, is now in custody after she allegedly ate her daughter's newborn baby....

AZ-365.TOP



**28-Year-Old Texas Teacher Accused of Sending Nude
Picture to 14-Year-Old Former Student**

BREITBART.COM

Newton 's Law of Cooling by Prof. Subhashish Chattopadhyay SKMClasses Bangalore Useful for IIT-JEE, CBSE, I.Sc. PU-II, Boards, CET, CEE, PET, IGCSE IB AP-Physics and other exams

<http://latest.com/.../attractive-girl-gang-lured-men-alleywa.../>



Attractive Girl Gang Lured Men Into Alleyways Where Female Body Builder Would Attack Them

A Mexican street gang made up entirely of women has been accused of using their feminine wiles to lure men into alleyways and then beating them up and...

LATEST.COM

<http://www.wfmj.com/.../youngstown-woman-convicted-of-rape-...>



Youngstown woman convicted of raping a 1 year old is back in jail

A Youngstown woman who went to prison for raping a 1-year-old boy fifteen years ago is in trouble with the law again.

WFMJ.COM

End violence against women ...



Women are raping boys and young men

Rape advocacy has been maligned and twisted into a political agenda controlled by radicalized activists. Tim Patten takes a razor keen and well supported look into the manufactured rape culture and...

AVOICEFORMEN.COM | BY TIM PATTEN



Bronx Woman Convicted of Poisoning and Drowning Her Children

Lisette Barnenga researched methods on the Internet before she killed her son and daughter in 2012.

NYTIMES.COM | BY MARC SANTORA

Monster women have very easy and cozy life. Easy to demand anything and get law in favor !

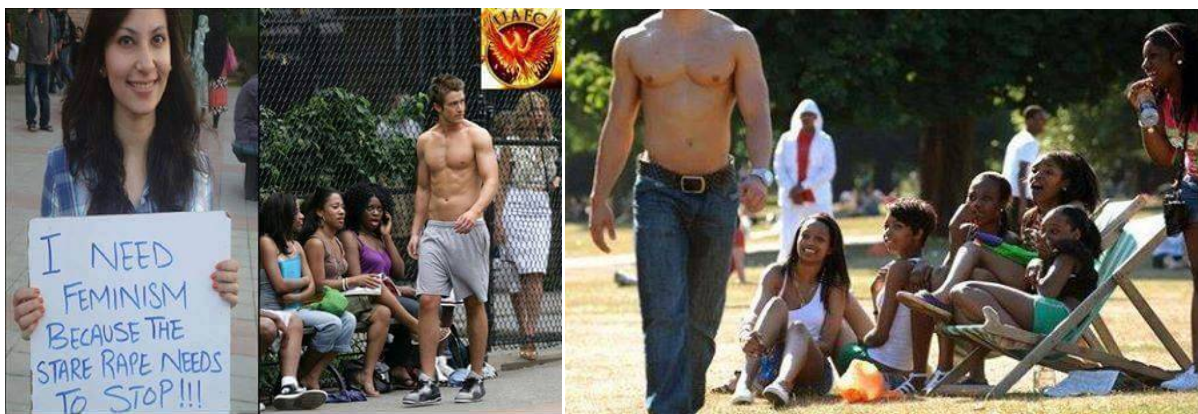

If the lawmakers submit to these strange demands of say ... " Stare Rape ! "; then we can easily see what kind of havoc that will create.

Newton 's Law of Cooling by Prof. Subhashish Chattopadhyay SKMClasses Bangalore Useful for IIT-JEE, CBSE, I.Sc. PU-II, Boards, CET, CEE, PET, IGCSE IB AP-Physics and other exams

Newton 's Law of Cooling by Prof. Subhashish Chattopadhyay SKMClasses Bangalore Useful for IIT-JEE, CBSE, I.Sc. PU-II, Boards, CET, CEE, PET, IGCSE IB AP-Physics and other exams

55%
of Biological Parents
Who Kill Their Children are
Mothers

Homicidal Encounters: A Study of Homicide in Australia 1989-1999.
Australian Institute of Criminology (Monash, 2000, p. 142, Fig. 74).

ManKind
Equality Network



Woman charged with killing baby also had previous infant die

Woman charged with killing baby also had previous infant die

ABC7.COM | BY ROB MCMILLAN



Female Sex Predators: A Crime Epidemic shared a link.

Yesterday at 12:40am · 🌐



WTVA.com | Woman pleads guilty to having sex with a dog

PITTSBORO, Miss. (WTVA) -- A Calhoun County woman has pleaded guilty to charges she had unnatural intercourse with a dog. Sheriff Greg Poll

WTVA.COM

👍 Like 💬 Comment ➦ Share

👍 🤔 🤢 Mhra Leander Pallat, Eric Antonio Alvarado and 31 others Top Comments ▾



Oklahoma Teacher Receives 15-Year Prison Sentence For Sex With 15-Year-Old Boy

A former Oklahoma middle school teacher has pleaded guilty to 6 counts of rape, child enticement...

THREEPERCENTERNATION.COM

Newton 's Law of Cooling by Prof. Subhashish Chattopadhyay SKMClasses Bangalore Useful for IIT-JEE, CBSE, I.Sc. PU-II, Boards, CET, CEE, PET, IGCSE IB AP-Physics and other exams

Newton 's Law of Cooling by Prof. Subhashish Chattopadhyay SKMClasses Bangalore Useful for IIT-JEE, CBSE, I.Sc. PU-II, Boards, CET, CEE, PET, IGCSE IB AP-Physics and other exams

A Russian-born newlywed slowly butchered her German husband — feeding strips of his flesh to their dog until he took his last breath. Svetlana Batukova, 46, was...

See More



She killed her husband and then fed him to her dog: police

A Russian-born newlywed butchered her German hubby — and fed strips of his flesh to her pooch, authorities said. Svetlana Batukova offered Horst Hans Henkels at their...

NYPOST.COM

 **Daily Mail**
January 15, 2015

Mother charged with rape and sodomy of her son's 12-year-old friend



Mom, 30, 'raped and had oral sex with her son's 12-year-old friend'

Nicole Marie Smith, 30, (pictured) of St Charles County, Missouri, has been jailed after she allegedly targeted the 12-year-old boy at her home.

DAILYMAIL

April 4 at 4:48am



Female prison officers commit 90pc of sex assaults on male teens in US juvenile detention centres

Lawsuit in Idaho highlights the prevalence of sexual victimization of juvenile offenders.

BTIMES.CO.UK | BY NICOLE ROJAS

This mother filmed herself raping her own son and then sold it to a man for \$300. The courts just decide her fate. When you see what she got, you're going to be outraged.



Mother Who Filmed Herself Raping Her 1-Year-Old Son Receives Shocking Sentence

"...then used the money to buy herself a laptop..."

AMERICANNEWS.COM

In several countries or rather in several regions of the world, family system has collapsed, due to bad nature and naughty acts of women. Particularly in Britain, and America, almost 50% people are alone, lonely, separated, divorced or failed marriages. In 2013, 48% children were born out of wedlock. **It was projected that by 2016, more than 51% children will be born, to unmarried mothers.** In these developed countries " paternity fraud " by women, are close to 20%. You can see several articles in the net, and in wikipedia etc. This means 1 out of 5 children are calling a wrong man as dad. The lonely, alone " mothers " are frustrated. They see the children as burden. Love in the Society in general is lost, long time ago. The types of " Mothers " and " Women " we have now

Newton 's Law of Cooling by Prof. Subhashish Chattopadhyay SKMClasses Bangalore Useful for IIT-JEE, CBSE, I.Sc. PU-II, Boards, CET, CEE, PET, IGCSE IB AP-Physics and other exams

This is the type of women we have in this world. These kind of women were also someones daughter



Mother Stabs Her Baby 90 Times With Scissors After He Bit Her While Breastfeeding Him!

Eight-month-old Xiao Bao was discovered by his uncle in a pool of blood. He needed 100 stitches after the incident; he is now recovering in hospital. Reports say his...

MOMMABUZZ.COM



Newton 's Law of Cooling by Prof. Subhashish Chattopadhyay SKMClasses Bangalore Useful for IIT-JEE, CBSE, I.Sc. PU-II, Boards, CET, CEE, PET, IGCSE IB AP-Physics and other exams

Not All Feminist Theory is Equal

<p>Christina Hoff Sommers Factual and Equity Feminist</p> 	<p>Andrea Dworkin Radical and Gender Feminist</p> 
<p>"That is the corrosive paradox of gender feminism's misandrist stance: no group of women can wage war on men without at the same time denigrating the women who respect those men."</p>	<p>"Under patriarchy, every woman's son is her potential betrayer and also the inevitable rapist or exploiter of another woman"</p>

ManKind
Equality Network

WILLFUL BLINDNESS

Ignoring the Majority of Victims Because of Their Gender

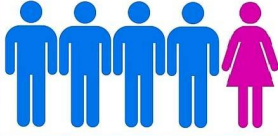
<p>I am a feminist because it bothers me that a woman gets killed by her male partner every single week, and somehow that doesn't qualify as a tools-down national crisis even though if a man got killed by a shark every week we'd probably arrange to have the ocean drained.</p> <p style="text-align: right;">Annabel Crabb</p>	<p>79% of Homicide victims worldwide are MALE</p> <p>"Where is the tools-down national crisis?"</p> 
--	---

United Nations Office of Drugs and Alcohol. Global Study on Homicide (2013, p. 13).
https://en.wikipedia.org/wiki/Willful_blindness

ManKind
Equality Network

Not All Feminist Theory is Equal

<p>Christina Hoff Sommers Equity Feminist</p> 	<p>Valerie Solanis Radical and Gender Feminist</p> 
<p>Christina H. Sommers @CH-Sommers</p> <p>Want to close wage gap? Step one: Change your major from feminist dance therapy to electrical engineering.</p>	<p>"To call a man an animal is to flatter him; he's a machine, a walking dildo"</p> <p style="text-align: right;"><small>n.b. Some Feminists</small></p>

ManKind
Equality Network



Muslim Woman Caught RAPING Her Own Son - Gives Disgusting Excuse to Judge | John Hawkins' Right Wing News

RIGHTWINGNEWS.COM

By now if you have assumed that Indian women are not doing any crime then please become friends with MRA Guri <https://www.facebook.com/profile.php?id=100004138754180>

He has dedicated his life to expose Indian Criminals



Delhi Woman Who Tried To Rape An Auto Driver, While Her Friend Filmed The Act, Has Been Arrested

Men are raped too!

MENSPX.COM | BY NIKITA MUKHERJEE



Muslim mother, 43, jailed for sex offences against girl, nine

Raheelah Dar, 43, from Middlesbrough, has been jailed for seven years for carrying out a string of sex offences against a nine-year-old girl.

DAILYMAIL.CO.UK

Newton 's Law of Cooling by Prof. Subhashish Chattopadhyay SKMClasses Bangalore Useful for IIT-JEE, CBSE, I.Sc. PU-II, Boards, CET, CEE, PET, IGCSE IB AP-Physics and other exams

MailOnline

U.K. | India | U.S. | **News** | Sport | TV&Showbiz | Femail | Health | Science | Money | Video | Latest Headlines | News | World News | Arts | Headlines | France | Pictures | Most read | News Board | Wires

Mother who had been forced into an arranged marriage is jailed for filming herself having sex with her 14-year-old son and sending the clips to relatives in Pakistan

- Vile mother filmed having sex with her teenage son in sick porn video
- Clips sent to cousin in Pakistan who allegedly asked her to make film
- She also sent her relative indecent images of her three-year-old daughter

By **ALEX MATTHEWS FOR MAILONLINE**

PUBLISHED: 12:44 GMT, 1 August 2016 | UPDATED: 11:23 GMT, 2 August 2016



Wife Stabs Husband And Runs Away After He Stops Her From Gambling

The husband said his wife had become a habitual gambler who was also addicted to liquor.

INDIATIMES.COM



Teacher learns fate for 6 months of sex with boy

(CBS8) — SAN DIEGO (CNS) — A Crawford High School teacher and coach who carried on a six-month sexual relationship with a 15-year-old male student was sentenced Friday to a two-year prison term. Toni Nicole Sutton, 38, pleaded guilty...

WIND.COM



Mom jailed for 40 years after body of daughter, 9, found in fridge

Amber Keyes, 37, was sentenced in the death of Ayahna Comb in Houston on Friday. Ayahna, who had cerebral palsy, had been in the fridge for six months...

DAILYMAIL.CO.UK









HURT FEMINISM BY DOING NOTHING

- ✗ DON'T HELP WOMEN
- ✗ DON'T FIX THINGS FOR WOMEN
- ✗ DON'T SUPPORT WOMEN'S ISSUES
- ✗ DON'T COME TO WOMEN'S DEFENSE¹
- ✗ DON'T SPEAK FOR WOMEN
- ✗ DON'T VALUE WOMEN'S FEELINGS
- ✗ DON'T PORTRAY WOMEN AS VICTIMS
- ✗ DON'T PROTECT WOMEN²

✓
WITHOUT WHITE KNIGHTS FEMINISM WOULD END TODAY

¹Don't even nawalt ("Not All Women Are Like That") ²for example from criticism or insults

How Society prioritize Men

High Priority	Rich women		They can get away with murder.
	Women		They get all the rights with no responsibility and Shelters for Homeless women.
	Rich Men		They get tax bail outs and short prison sentence.
	Girls		They get educational benefits but no violence against kids Act.
	Boys		They have some support but don't have any education that fits boys.
	Animals		They have animal rights and PETA.
	Prisoners		They get conjugal visits and 3 squares and a roof.
	Men		Paid slaves.
Low Priority	Poor Men		Nothing.

Who pays the most Taxes?
This is why MGTOW exist.

 # MGTOW



Professor Subhashish Chattopadhyay

Newton 's Law of Cooling by Prof. Subhashish Chattopadhyay SKMClasses Bangalore Useful for IIT-JEE, CBSE, I.Sc. PU-II, Boards, CET, CEE, PET, IGCSE IB AP-Physics and other exams

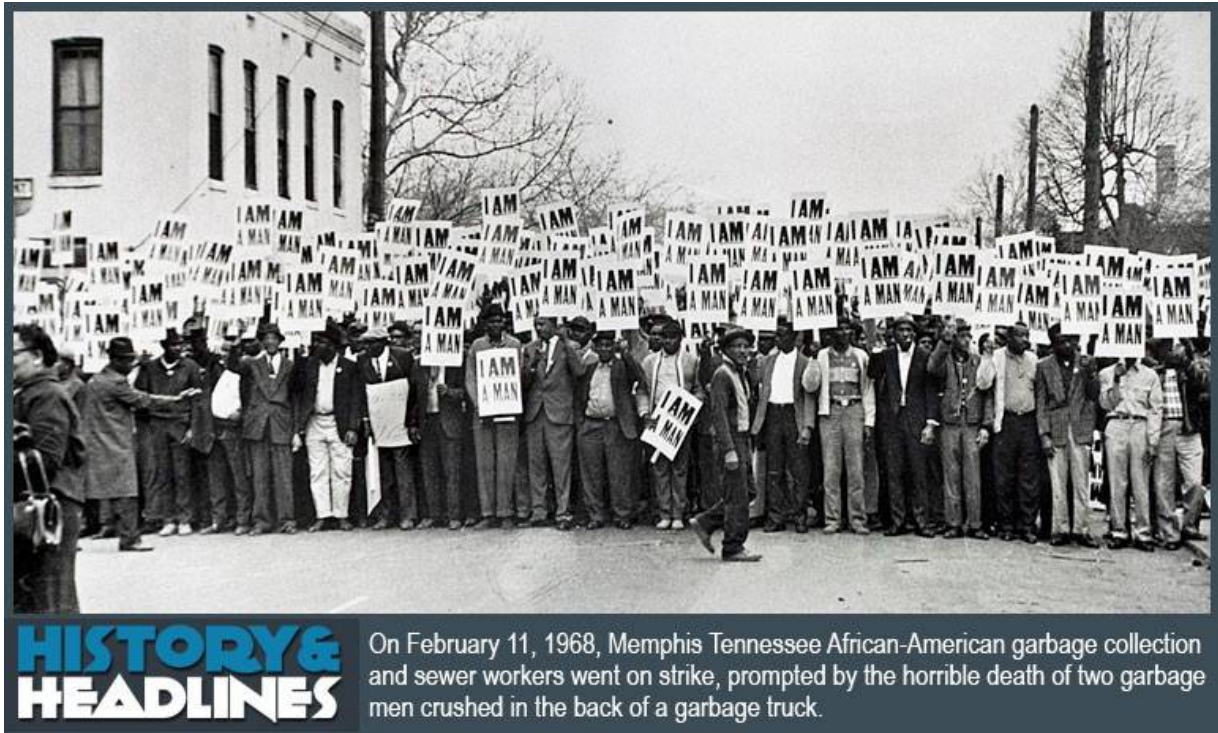

Read http://www.pdfarchive.info/pdf/S/Sm/Smith_Helen_-_Men_on_strike.pdf



What would happen if no men showed up for work today?

Yesterday's post got me thinking about what would happen if no men showed up to work today. For certain, the trains would stop running. But before we get into that,...

JUDGYBITCH.COM | BY JANET BLOOMFIELD (AKA JUDGYBITCH)

Read <http://judgybitch.com/2013/09/17/what-would-happen-if-no-men-showed-up-for-work-today/>

Newton 's Law of Cooling by Prof. Subhashish Chattopadhyay SKMClasses Bangalore Useful for IIT-JEE, CBSE, I.Sc. PU-II, Boards, CET, CEE, PET, IGCSE IB AP-Physics and other exams

Preface for Science

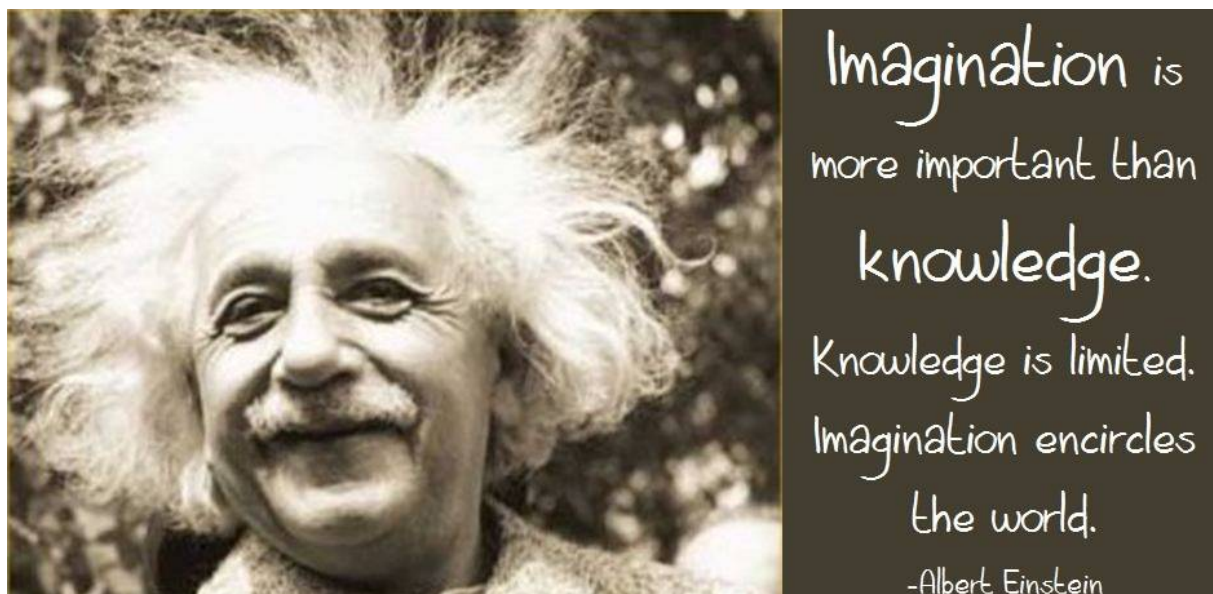

Many Scientists have made, very good TV programs; to teach Science. Carl Sagan, Desmond Morris, Jacques Cousteau, Neil deGrass Tyson, James Burke, Jacob Bronowski, Bill Nye, Andrew Pontzen, Sean Carroll, Michio Kaku, Brian Cox, Brian Greene, Freeman Dyson, Dr. Don Lincoln ... the list is long. BBC, Discovery Channel, Nova, Nature, Science Planet the list of good Channels is big.

Even though these programs are being delivered free, (add education programs of Govt. of India, which are also very good); not sure how many are correctly learning.

<https://www.youtube.com/watch?v=4sLGCeeA1UI&list=PLaMjJI9Tuw7HoCo8wzZNwMC7jjo3nrEvx>

As I randomly talk to lots of students ... I find ...

The Science understanding of Urban, Rich children, in general; is abysmal.

The Science fiction movies, showing Aliens; or winning war with Aliens are more popular and influential. Doraemon making "time machine" so easily, and doing "time travel" so often intrigues children more. (for General Knowledge see <http://skmclasses.weebly.com>)

India is an uniquely peculiar country; has 1.3 Billion people, obsessed with thousands of stupid things. Superstitious Religious Rituals, Hundreds of festivals, 'What to do' and 'what not to do' [on a full moon day, on a No Moon day, on 11 th day of Lunar month], before and after an eclipse, what to eat and what not to eat, what to wear and what not to wear, Caste, Gotra, "methods and steps" for Puja or Prayer, **hundreds of ways to control or restrict or influence others** etc... ; keeps people busy.

Newton 's Law of Cooling by Prof. Subhashish Chattopadhyay SKMClasses Bangalore Useful for IIT-JEE, CBSE, I.Sc. PU-II, Boards, CET, CEE, PET, IGCSE IB AP-Physics and other exams

Students have major influence and learning's from these superstitious life style, and fiction / 'stupid movies' rather than from good Science TV shows.

[if you ask any Science Question to any student, first reaction is “Ye to course mein nahi hai”!]

Another most important obsession of Indians is to become Engineers; well somehow 14 Lakh (1.4 million) students appear for IIT JEE exam. (Not about IITs or NITs etc) Almost all are stark idiots; study "Engineering" in some college or other the story goes on.

In general students / people in India do not know or understand the following ...

One of the most important drawbacks of Human beings is **Anthropophilia**. We love to imagine that ... God, Aliens, Robots etc, are similar to us. Tell a small child to draw a Robot, and almost 100% cases you see a Humanoid being drawn. It is not about the child being intelligent or smart. It is a fundamental 'mental block' that we harbor in general. [**when I was a kid, and if someone had told me to draw a Robot, I would have surely drawn a Humanoid**]

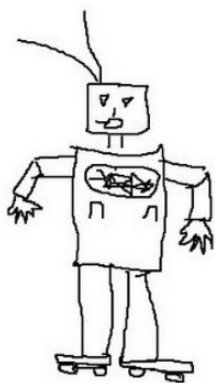

(if I tell you to draw a “Chemical Robot” then ?)



We feel comfortable with Humanoid Robots only

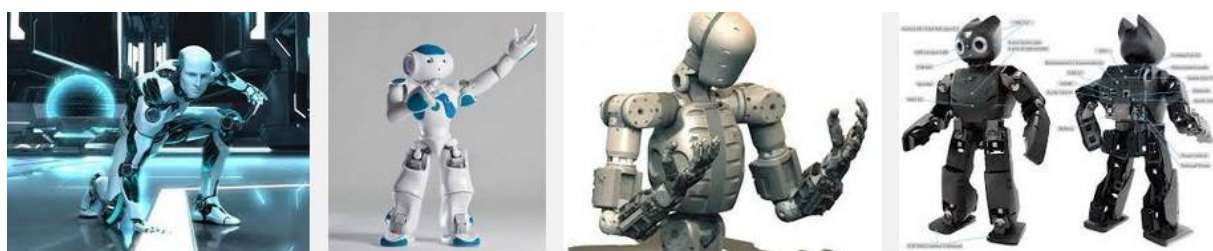

It takes lot of Training and maturity to understand that all machines are Robots. A car is a Robot. A crane is a Robot. Mars Rover is a Robot. Robots can be of any size and shape, serving a particular purpose.

Similarly Aliens do not have to look like us. We have five fingers in our hands, and five toes in our legs because Monkeys have the same. We all evolved step by step from some primitive fish, which had five bones / cartilages in its fins. The fish from which we all evolved had 2

Newton 's Law of Cooling by Prof. Subhashish Chattopadhyay SKMClasses Bangalore Useful for IIT-JEE, CBSE, I.Sc. PU-II, Boards, CET, CEE, PET, IGCSE IB AP-Physics and other exams

Newton 's Law of Cooling by Prof. Subhashish Chattopadhyay SKMClasses Bangalore Useful for IIT-JEE, CBSE, I.Sc. PU-II, Boards, CET, CEE, PET, IGCSE IB AP-Physics and other exams

pairs of fins. The pair of fins which was nearer to the head became hands, and the pair at the rear became legs.

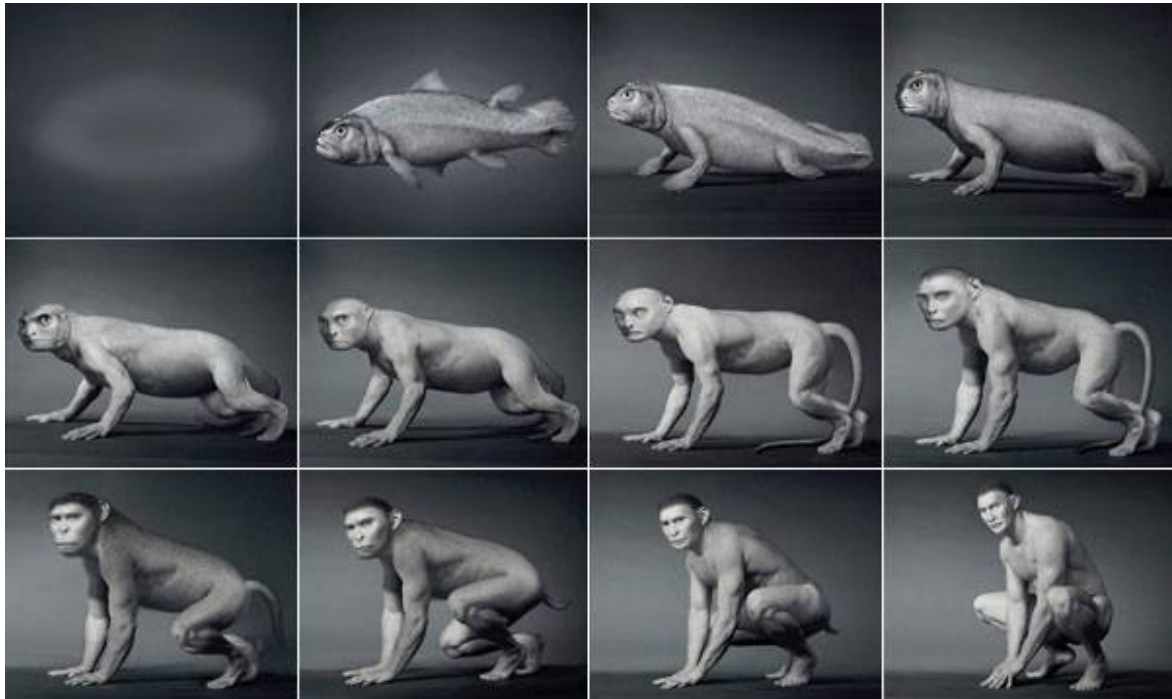

Now imagine an Alien evolving from a fish, which had 3 pairs of fins ! or say 17 pairs ! then that may lead to

Some children will be quick to identify that Aliens may not evolve from fish, can be different pathways ... in that case they will look very different from us isn't it !

As I write all these in 2016, I say " Soon we will find various life-forms in Mars, Moons of Jupiter, Jupiter, and Asteroids ! "

Back to Anthropophilia ... It is very difficult to get rid of this. Christiaan Huygens the great Dutch Scientist 'logically concluded' from observations as follows ...

Jupiter has Atmosphere, so it will rain in Jupiter, so Jupiter must have seas and Oceans, so the "life forms" in Jupiter must have boats, the boats need rope, and rope must be made from trees / fiber, so "they" should have hemp plants ...

Huygens was the first to make a submarine which could go down in water, by a few meters. In those days, around 1650 there was no plane, rocket or space travel. So do you see Huygens could not imagine Aliens in Jupiter flying in Planes or Rockets. While movies now show Aliens in Rockets!

[**Students must know about various limitations of Human beings.** Professor Daniel Kahnemen (2002 Nobel Laureate) has long list of Human Limitations in his book.

Newton 's Law of Cooling by Prof. Subhashish Chattopadhyay SKMClasses Bangalore Useful for IIT-JEE, CBSE, I.Sc. PU-II, Boards, CET, CEE, PET, IGCSE IB AP-Physics and other exams

Newton 's Law of Cooling by Prof. Subhashish Chattopadhyay SKMClasses Bangalore Useful for IIT-JEE, CBSE, I.Sc. PU-II, Boards, CET, CEE, PET, IGCSE IB AP-Physics and other exams

see https://vk.com/doc23267904_175119602

I collected some limitations, and wrote an article. See <http://skmclasses.kinja.com/bias-we-all-are-biased-1761664826>

Scientists have advised a list of "must learn" for students, to appreciate / understand Science better.

See Read <http://edge.org/responses/what-scientific-concept-would-improve-everybodys-cognitive-toolkit>

It is mandatory for students; to know all the points given in the above links; whom I personally teach]

Chimps and Humans have 96 Percent common genes; Research and Gene Study Finds. **But Humans and Chimps can't communicate, or discuss.** Orangutans are our nearest relatives. We humans are 97% the same as orangutans, gene study shows. But we can't converse with any other species. A little bit of sign language of say 100 "words" or a Dog understanding "instructions" of his master is **not** what is being referred here. **Earth has several Million species, while observations as of now, does not show "communication" across two separate species.** Let us not bring in Symbiotic relationship into this. It is about intelligent communication, discussions, debate, learning from each other etc. Can Humans communicate with insects or birds chirping ?

Imagine a World where Lions were communicating with insects, or say Otters communicating with birds ! The ecosystem as we know, has all these staying together ... so close ! All like a family !! <http://www.telegraph.co.uk/science/2016/09/11/dolphins-recorded-having-a-conversation-for-first-time/>

Simard discovered that **different tree species are in contact with one another.**

Some **birds** which fly very long distances; do that by sensing Magnetic fields. The eyes of the bird is sensing these feeble magnetic field of Earth by **Quantum entangled Particles**. As the light photons reach and "react" with various Chemicals, the entangled particles are released. These particles "enable" the birds brain to detect Magnetic fields. Does one bird communicate or Guide another with similar mechanisms ?

Trees, it turns out, have a completely different way of communicating: they use scent. It was found that acacias start pumping toxic substances into their leaves to rid themselves of the large herbivores, when being eaten. Beeches, spruce, and oaks all register pain as soon as some creature starts nibbling on them. When a caterpillar takes a hearty bite out of a leaf; the tissue around the site of the damage changes. In addition, the leaf tissue sends out electrical signals, just as human tissue does when it is hurt. However, the signal is not transmitted in milliseconds, as human signals are; instead, the plant signal travels at the slow speed of a third of an inch per minute. Accordingly, it takes an hour or so before defensive compounds reach the leaves to spoil the pest's meal. Trees live their lives in the really slow

Newton 's Law of Cooling by Prof. Subhashish Chattopadhyay SKMClasses Bangalore Useful for IIT-JEE, CBSE, I.Sc. PU-II, Boards, CET, CEE, PET, IGCSE IB AP-Physics and other exams

Newton 's Law of Cooling by Prof. Subhashish Chattopadhyay SKMClasses Bangalore Useful for IIT-JEE, CBSE, I.Sc. PU-II, Boards, CET, CEE, PET, IGCSE IB AP-Physics and other exams

lane, even when they are in danger. If the roots find themselves in trouble, this information is broadcast throughout the tree, which can trigger the leaves to release scent compounds. And not just any old scent compounds, but compounds that are specifically formulated for the task at hand. [[Discussing more of this later in the book](#)]

Now do we see the limitations about our obsession, with "communicating" with Aliens ?

The nearest stars are several light years away. Even if we improve the technology to travel 1000 times faster than the fastest rockets it will take thousands of years to travel to nearest "Earth like" planets. **I personally rule out any more discussions on travelling and meeting and communicating with Aliens.**

The life forms (which we will soon find) in Mars, Moons of Jupiter, Jupiter etc **have to be analyzed for DNA**. Will these life-forms have DNA ? Will these Aliens have molecules similar to what we see in organisms here in Earth ? These are important questions in Xenobiology, Astrobiology etc. **We have to wait for data**.

Science is study of data, experimental verification, logical conclusions.

We have made XNA. We have made various kinds of Artificial life, including Arsenic, Selenium based pathways. But extremeophiles also have the same kind of DNA or molecules that we see in all organisms. Same kinds of mRNA etc. Why didn't life grow and evolve multiple times ? We don't know as of now. Or did life evolve / grow multiple times in the same way ? Intelligent human beings will keep researching, and we will know the answers.

The only Sanskrit word in Standard 11-12 Science CBSE text books is Tincal (which is the word for Borax). The books (rightly) are full with German names. Students are unaware the Potassium was derived from an Arabic word Potash, ashes of (roots) of plant.

(not talking about last 50 or 100 years) **Not a single chemical element were purified / synthesized or discovered in India, by any Indian**. Indium (In = #49): Indicum (Latin) means indigo. The pigment indigo was named after indicon (Greek) in allusion for its coming from India. On August 18th, 1868 by French astronomer Jules Janssen. While in Guntur, India, Janssen observed a solar eclipse through a prism, whereupon he noticed a bright yellow spectral line (at 587.49 nanometers) emanating from the chromosphere of the Sun. This led to discovery of Helium. In 1937, Discovery of Astatine was reported by the chemist Rajendralal De. Working in Dacca in British India (now Dhaka in Bangladesh), he chose the name "**dakin**" for element 85, which he claimed to have isolated as the thorium series equivalent of radium F (polonium-210) in the radium series. The properties he reported for **dakin** do not correspond to those of astatine; moreover, astatine is not found in the thorium series, and the true identity of **dakin** is not known.

[not considering the ancient elements which were known to others also ... Supher, Zinc, Mercury and <http://www.thehindu.com/sci-tech/science/indian-role-in-producing-superheavy-element-117/article5986191.ece>]

Newton 's Law of Cooling by Prof. Subhashish Chattopadhyay SKMClasses Bangalore Useful for IIT-JEE, CBSE, I.Sc. PU-II, Boards, CET, CEE, PET, IGCSE IB AP-Physics and other exams

Newton 's Law of Cooling by Prof. Subhashish Chattopadhyay SKMClasses Bangalore Useful for IIT-JEE, CBSE, I.Sc. PU-II, Boards, CET, CEE, PET, IGCSE IB AP-Physics and other exams

As a culture Indians preferred Ayurveda. Identify the trees, smash the leaves, take the bark and / or the roots, make a paste, in some cases add honey etc ... and this paste or potion cures everything. If we do not have a medicine for some disease, or if the medicine is not effective, then the argument is ... "we did not search the trees in the jungle enough !". The belief being solution / medicine for every disease is out there in the jungle!

This culture is grossly opposite to get into the details, identify the molecules, find the reaction pathways. Modern techniques is not seen as good. In fact opposite ... **older things are considered better.** The claim often is "some grandfather's grandfather was a great Ayurvedic Doctor, since several generations they are using some paste, and they now the best.

With this kind of a culture Indians cannot and did not find pharmacophores.

[see <http://www.eurekaselect.com/81348/article>

<http://www.ucdenver.edu/academics/colleges/medicalschoo/department/Pharmacology/Pages/history.aspx>

<http://adaptogens.org/adaptogen/history>]

An extremely superstitious culture, avoiding to get-into any details, easy way of "chalta hai" had its Dark effect. Indians are averages and poor, because hardly there was any value-add !

Most people in India; think in the following way ...



Let us see contribution of some Mathematicians and Scientists; who did great work but students generally don't know about them.

Eugene Wigner - After his sojourn in Berlin, Wigner returned to Budapest to work in his father's tannery. Somehow and somewhere from there, he returned to Berlin joining the Kaiser Wilhelm Institute working first under Karl Weissenberg and later under Richard Becker. There he explored quantum mechanics of Erwin Schrödinger and group theory (founded by

Newton 's Law of Cooling by Prof. Subhashish Chattopadhyay SKMClasses Bangalore Useful for IIT-JEE, CBSE, I.Sc. PU-II, Boards, CET, CEE, PET, IGCSE IB AP-Physics and other exams

Newton 's Law of Cooling by Prof. Subhashish Chattopadhyay SKMClasses Bangalore Useful for IIT-JEE, CBSE, I.Sc. PU-II, Boards, CET, CEE, PET, IGCSE IB AP-Physics and other exams

the genius Evariste Galois who was obsessed with polynomials equations and their solutions). At the age of 25, in 1927, in Germany somewhere he introduced the group theory into quantum mechanics. He published it formally in 1931 at the age of 29:

"Group Theory and Its Application to the Quantum Mechanics of Atomic Spectra."

He soon thereafter introduced symmetries (rotations, translations, and CPT- charge parity and time reversal symmetry) into quantum mechanics. He formulated and proved a theorem which became the cornerstone of the mathematical formulations of quantum mechanics. Eugene Wigner was so impressed with the usefulness of abstract mathematics in nuclear physics and quantum mechanics that he went on to write a landmark article in 1960 titled:

"The Unreasonable Effectiveness of Mathematics in the Natural Sciences".

In 1930, Princeton University recruited both Jeno Pal Wigner and Janos Von Neumann at 7 times the salary they were drawing in Europe. Both these geniuses anglicized their first names to "Eugene" and "John" respectively and soon thereafter became naturalized citizens of the United States.

-

Janos Bolyai (Transylvania, Hapsburg Empire) 1822 - one of the founders of non-Euclidean geometry – a geometry that differs from Euclidean geometry in its definition of parallel lines. The discovery of a consistent alternative geometry that might correspond to the structure of the universe helped to free mathematicians to study abstract concepts irrespective of any possible connection with the physical world.

Nikolai Ivanovich Lobachevsky (Kazan, Russia) 1823 - known primarily for his work on hyperbolic geometry, otherwise known as Lobachevskian geometry. William Kingdon Clifford called Lobachevsky the "Copernicus of Geometry" due to the revolutionary character of his work. He was dismissed from the university in 1846, ostensibly due to his deteriorating health: by the early 1850s, he was nearly blind and unable to walk. He died in poverty in 1856.

Nikolai was an atheist.

-

Bernhard Riemann (Breselenz, Jameln, Kingdom of Hanover) 1853: student of Gauss - Influential German mathematician who made lasting and revolutionary contributions to analysis, number theory, and differential geometry. In the field of real analysis, he is mostly known for the first rigorous formulation of the integral, the Riemann integral, and his work on Fourier series. His contributions to complex analysis include most notably the introduction of Riemann surfaces, breaking new ground in a natural, geometric treatment of complex analysis. His famous 1859 paper on the prime-counting function, containing the original statement of the Riemann hypothesis, is regarded, although it is his only paper in the field, as one of the most influential papers in analytic number theory. Through his pioneering

Newton 's Law of Cooling by Prof. Subhashish Chattopadhyay SKMClasses Bangalore Useful for IIT-JEE, CBSE, I.Sc. PU-II, Boards, CET, CEE, PET, IGCSE IB AP-Physics and other exams

Newton 's Law of Cooling by Prof. Subhashish Chattopadhyay SKMClasses Bangalore Useful for IIT-JEE, CBSE, I.Sc. PU-II, Boards, CET, CEE, PET, IGCSE IB AP-Physics and other exams

contributions to differential geometry, Riemann laid the foundations of the mathematics of general relativity.

-

Felix Klein (Düsseldorf, Prussia) 1870s - German mathematician and mathematics educator, known for his work in group theory, complex analysis, non-Euclidean geometry, and on the connections between geometry and group theory. His 1872 Erlangen Program, classifying geometries by their underlying symmetry groups, was a hugely influential synthesis of much of the mathematics of the day.

-

Marcel Grossman (Budapest) 1910s tutored Einstein on differential geometry and tensor calculus - mathematician and a friend and classmate of Albert Einstein. Grossmann was a member of an old Swiss family from Zurich. His father managed a textile factory. He became a Professor of Mathematics at the Federal Polytechnic Institute in Zurich, today the ETH Zurich, specializing in descriptive geometry.

-

Gregorio Ricci-Curbastro (Italy) 1880s - Italian mathematician born in Lugo di Romagna. He is most famous as the inventor of tensor calculus, but also published important works in other fields. With his former student Tullio Levi-Civita, he wrote his most famous single publication, a pioneering work on the calculus of tensors, signing it as Gregorio Ricci. This appears to be the only time that Ricci-Curbastro used the shortened form of his name in a publication, and continues to cause confusion. Ricci-Curbastro also published important works in other fields, including a book on higher algebra and infinitesimal analysis, and papers on the theory of real numbers, an area in which he extended the research begun by Richard Dedekind.

-

Ernst Mach (Moravia, Austrian Empire) 1900s who totally abhorred Newton's idea of absolute space and time - Austrian physicist and philosopher, noted for his contributions to physics such as study of shock waves. Quotient of one's speed to that of sound is named the Mach number in his honor. As a philosopher of science, he was a major influence on logical positivism, American pragmatism and through his criticism of Newton, a forerunner of Einstein's relativity.

-

Hendrik Lorentz (Netherlands) 1900s - Dutch physicist who shared the 1902 Nobel Prize in Physics with Pieter Zeeman for the discovery and theoretical explanation of the Zeeman effect. He also derived the transformation equations which formed the basis of the special relativity theory of Albert Einstein. According to the biography published by the Nobel Foundation, "It may well be said that Lorentz was regarded by all theoretical physicists as the

Newton 's Law of Cooling by Prof. Subhashish Chattopadhyay SKMClasses Bangalore Useful for IIT-JEE, CBSE, I.Sc. PU-II, Boards, CET, CEE, PET, IGCSE IB AP-Physics and other exams

Newton 's Law of Cooling by Prof. Subhashish Chattopadhyay SKMClasses Bangalore Useful for IIT-JEE, CBSE, I.Sc. PU-II, Boards, CET, CEE, PET, IGCSE IB AP-Physics and other exams

world's leading spirit, who completed what was left unfinished by his predecessors and prepared the ground for the fruitful reception of the new ideas based on the quantum theory." For this he received many honours and distinctions during his life, including—from 1925 to his death in 1928—the role of Chairman of the exclusive International Committee on Intellectual Cooperation.

-

Willem De Sitter (Netherlands) 1920s - Dutch mathematician, physicist, and astronomer. De Sitter made major contributions to the field of physical cosmology. He co-authored a paper with Albert Einstein in 1932 in which they discussed the implications of cosmological data for the curvature of the universe. He also came up with the concept of the de Sitter space and de Sitter universe, a solution for Einstein's general relativity in which there is no matter and a positive cosmological constant. This results in an exponentially expanding, empty universe. De Sitter was also famous for his research on the planet Jupiter.

-

Alexander Friedmann (St. Petersburg, Russian Empire) 1920s - was a Russian and Soviet physicist and mathematician. He is best known for his pioneering theory that the universe was expanding, governed by a set of equations he developed now known as the Friedmann equations.

-

Georges Lemaitre (Belgium) 1920s - was a Belgian priest, astronomer and professor of physics at the Catholic University of Leuven. He proposed the theory of the expansion of the universe, widely misattributed to Edwin Hubble. He was the first to derive what is now known as Hubble's law and made the first estimation of what is now called the Hubble constant, which he published in 1927, two years before Hubble's article. Lemaitre also proposed what became known as the Big Bang theory of the origin of the universe; which he called his "hypothesis of the primeval atom" or the "Cosmic Egg".

-

One of the greatest help we apes got; **was with the discovery or invention of mass spectrometry.**

The men who invented this device were (at least Two; as claimed by the Western English speaking world).

1. Englishman Francis William Aston in 1919
2. Canadian American Arthur Jeffrey Dempster in 1918.

Newton 's Law of Cooling by Prof. Subhashish Chattopadhyay SKMClasses Bangalore Useful for IIT-JEE, CBSE, I.Sc. PU-II, Boards, CET, CEE, PET, IGCSE IB AP-Physics and other exams

Newton 's Law of Cooling by Prof. Subhashish Chattopadhyay SKMClasses Bangalore Useful for IIT-JEE, CBSE, I.Sc. PU-II, Boards, CET, CEE, PET, IGCSE IB AP-Physics and other exams

Just imagine as Europe was involved in one of their bloodiest slaughter and carnage, these men were quietly working in their labs devising an instrument that could sort out atoms and ions based on their charge to mass ratio.

(I wish to emphasize yet again that even though atoms are a fact, we using the term atomic theory till date.)

By 1919, Aston had achieved 2 feats:

1. He showed that atoms of a single element could have different isotopes thereby establishing as fact that even non radioactive elements have isotopes.
2. He had invented the first mass spectroscopy.

The Canadian Dempster had greatly improved on it, greatly increasing its accuracy in identifying compounds by mass of elements in a sample. This was a gigantic step to our understanding of nature.

-

David Goldberg - David Edward Goldberg (born September 26, 1953) is an American computer scientist, civil engineer, and professor at the department of Industrial and Enterprise Systems Engineering (IESE) at the University of Illinois at Urbana-Champaign and is most noted for his work in the field of genetic algorithms. He is the director of the Illinois Genetic Algorithms Laboratory (IlligAL) and the chief scientist of Nextumi Inc. He is the author of Genetic Algorithms in Search, Optimization and Machine Learning, one of the most cited books in computer science.

In computer science and operations research, a genetic algorithm (GA) is a metaheuristic inspired by the process of natural selection that belongs to the larger class of evolutionary algorithms (EA). Genetic algorithms are commonly used to generate high-quality solutions to optimization and search problems by relying on bio-inspired operators such as mutation, crossover and selection.

-

Lotfi Zadeh - The term fuzzy logic was introduced with the 1965 proposal of fuzzy set theory by Lotfi Zadeh. Fuzzy logic had however been studied since the 1920s, as infinite-valued logic—notably by Łukasiewicz and Tarski. Fuzzy logic is a form of many-valued logic in which the truth values of variables may be any real number between 0 and 1, considered to be "fuzzy". By contrast, in Boolean logic, the truth values of variables may only be 0 or 1, often called "crisp" values. Fuzzy logic has been applied to many fields, from control theory to artificial intelligence.

-

Warren McCulloch and Walter Pitts - (1943) created a computational model for neural networks based on mathematics and algorithms called threshold logic. This model paved the

Newton 's Law of Cooling by Prof. Subhashish Chattopadhyay SKMClasses Bangalore Useful for IIT-JEE, CBSE, I.Sc. PU-II, Boards, CET, CEE, PET, IGCSE IB AP-Physics and other exams

Newton 's Law of Cooling by Prof. Subhashish Chattopadhyay SKMClasses Bangalore Useful for IIT-JEE, CBSE, I.Sc. PU-II, Boards, CET, CEE, PET, IGCSE IB AP-Physics and other exams

way for neural network research to split into two distinct approaches. One approach focused on biological processes in the brain and the other focused on the application of neural networks to artificial intelligence.

In the late 1940s psychologist **Donald Hebb** created a hypothesis of learning based on the mechanism of neural plasticity that is now known as **Hebbian learning**. Hebbian learning is considered to be a 'typical' unsupervised learning rule and its later variants were early models for long term potentiation. Researchers started applying these ideas to computational models in 1948 with Turing's B-type machines.

Farley and Wesley A. Clark (1954) first used computational machines, then called "calculators," to simulate a Hebbian network at MIT. Other neural network computational machines were created by Rochester, Holland, Habit, and Duda (1956).

Frank Rosenblatt (1958) created the perceptron, an algorithm for pattern recognition based on a two-layer computer learning network using simple addition and subtraction. With mathematical notation, Rosenblatt also described circuitry not in the basic perceptron, such as the exclusive-or circuit, a circuit which could not be processed by neural networks until after the backpropagation algorithm was created by Paul Werbos (1975).

Neural network research stagnated after the publication of machine learning research by Marvin Minsky and **Seymour Papert** (1969), who discovered two key issues with the computational machines that processed neural networks. The first was that basic perceptrons were incapable of processing the exclusive-or circuit. The second significant issue was that computers didn't have enough processing power to effectively handle the long run time required by large neural networks. Neural network research slowed until computers achieved greater processing power.

-

Interval arithmetic, interval mathematics, interval analysis, or interval computation, is a method developed by mathematicians since the 1950s and 1960s, as an approach to putting bounds on rounding errors and measurement errors in mathematical computation and thus developing numerical methods that yield reliable results. Very simply put, it represents each value as a range of possibilities. For example, instead of estimating the height of someone using standard arithmetic as 2.0 meters, using interval arithmetic we might be certain that that person is somewhere between 1.97 and 2.03 meters. In mathematics, a (real) interval is a set of real numbers with the property that any number that lies between two numbers in the set is also included in the set. For example, the set of all numbers x satisfying $0 \leq x \leq 1$ is an interval which contains 0 and 1, as well as all numbers between them.

This concept is suitable for a variety of purposes. The most common use is to keep track of and handle rounding errors directly during the calculation and of uncertainties in the knowledge of the exact values of physical and technical parameters. The latter often arise from measurement errors and tolerances for components or due to limits on computational

Newton 's Law of Cooling by Prof. Subhashish Chattopadhyay SKMClasses Bangalore Useful for IIT-JEE, CBSE, I.Sc. PU-II, Boards, CET, CEE, PET, IGCSE IB AP-Physics and other exams

Newton 's Law of Cooling by Prof. Subhashish Chattopadhyay SKMClasses Bangalore Useful for IIT-JEE, CBSE, I.Sc. PU-II, Boards, CET, CEE, PET, IGCSE IB AP-Physics and other exams

accuracy. Interval arithmetic also helps find reliable and guaranteed solutions to equations and optimization problems.

-

Nassim Nicholas Taleb and Benoit Mandelbrot -

Nassim is a Lebanese-American essayist, scholar, statistician, former trader, and risk analyst, whose work focuses on problems of randomness, probability, and uncertainty. His 2007 book *The Black Swan* was described in a review by the *Sunday Times* as one of the twelve most influential books since World War II. He advocates what he calls a "black swan robust" society, meaning a society that can withstand difficult-to-predict events.

Benoit Mandelbrot was a Polish-born, French and American mathematician with broad interests in the practical sciences, especially regarding what he labeled as "the art of roughness" of physical phenomena and "the uncontrolled element in life." He referred to himself as a "fractalist". He is recognized for his contribution to the field of fractal geometry, which included coining the word "fractal", as well as developing a theory of "roughness and self-similarity" in nature. He spent most of his career in both the United States and France, having dual French and American citizenship. In 1958, he began a 35-year career at IBM, where he became an IBM Fellow, and periodically took leaves of absence to teach at Harvard University. Because of his access to IBM's computers, Mandelbrot was one of the first to use computer graphics to create and display fractal geometric images, leading to his discovering the Mandelbrot set in 1979. He showed how visual complexity can be created from simple rules. He said that things typically considered to be "rough", a "mess" or "chaotic", like clouds or shorelines, actually had a "degree of order." His math and geometry-centered research career included contributions to such fields as statistical physics, meteorology, hydrology, geomorphology, anatomy, taxonomy, neurology, linguistics, information technology, computer graphics, economics, geology, medicine, cosmology, engineering, chaos theory, econophysics, metallurgy, taxonomy and the social sciences.

[Nassim, Benoit Mandelbrot and many others showed that application of Fractals / Mandrelbot is better to predict several practical outcomes, in contrast to Gaussian distribution analysis.](#)

-

Charles Darwin told his friend that, he guesses; Life may have started in a shallow hot pond. Darwin was many hundred years ahead of his times.

The Murchison meteorite that fell near Murchison, Victoria, Australia in 1969 was found to contain over 90 different amino acids, nineteen of which are found in Earth life. Comets and other icy outer-solar-system bodies are thought to contain large amounts of complex carbon compounds (such as tholins) formed by these processes, darkening surfaces of these bodies.

Newton 's Law of Cooling by Prof. Subhashish Chattopadhyay SKMClasses Bangalore Useful for IIT-JEE, CBSE, I.Sc. PU-II, Boards, CET, CEE, PET, IGCSE IB AP-Physics and other exams

Newton 's Law of Cooling by Prof. Subhashish Chattopadhyay SKMClasses Bangalore Useful for IIT-JEE, CBSE, I.Sc. PU-II, Boards, CET, CEE, PET, IGCSE IB AP-Physics and other exams

The early Earth was bombarded heavily by comets, possibly providing a large supply of complex organic molecules along with the water and other volatiles they contributed.

The University of Waterloo and University of Colorado conducted simulations in 2005 that indicated that the early atmosphere of Earth could have contained up to 40 percent hydrogen—implying a much more hospitable environment for the formation of prebiotic organic molecules. The escape of hydrogen from Earth's atmosphere into space may have occurred at only one percent of the rate previously believed based on revised estimates of the upper atmosphere's temperature.

Researchers at the Rensselaer Polytechnic Institute in New York reported the possibility of oxygen available around 4.3 billion years ago. Their study reported in 2011 on the assessment of Hadean zircons from the earth's interior (magma) indicated the presence of oxygen traces similar to modern-day lavas.

700 Million years after Earth's origin, (around 3.8 Billion years ago), the Rocks have signatures of Microbe Life. Just 540 million year ago diversity of life happened (Cambrian Explosion). So for almost 3 Billion years Earth had only Microbes. The day was around 22 hours then, as Earth was rotating quicker.

Studies have been made of the amino acid composition of the products of "old" areas in "old" genes, defined as those that are found to be common to organisms from several widely separated species, assumed to share only the last universal ancestor (LUA) of all extant species. These studies found that the products of these areas are enriched in those amino acids that are also most readily produced in the Miller-Urey experiment. This suggests that the original genetic code was based on a smaller number of amino acids - only those available in prebiotic nature - than the current one.

Cyanobacteria are able to survive extreme conditions. They live in Antarctica as well as in mountain springs. One species was isolated even from polar bear hairs.

Cyanobacteria get their name from the bluish pigment phycocyanin, which they use to capture light for photosynthesis as they also contain chlorophyll. Their name comes from the Greek word for blue, cyanos. Cyanobacteria have been living on the Earth for more than 3 billion years. They alter genetically and develop various evolutionary lines. They have survived here for a uniquely long time. These are microscopic, they are rich in chemical diversity. the chloroplast in plants is a symbiotic cyanobacterium, taken up by a green algal ancestor of the plants sometime in the Precambrian. These bacteria are often found growing on greenhouse glass, or around sinks and drains. The Red Sea gets its name from occasional blooms of a reddish species of Oscillatoria, and African flamingos get their pink color from eating Spirulina.

The scientific community has gained a clearer understanding of the evolution of cyanobacteria of the Synechococcus group. It is one of the largest groups of cyanobacteria, widespread from the poles to the equator, in the sea as well as on land. Petr Dvorák, a phycologist from the Faculty of Science, has compared their genes and constructed, with the

Newton 's Law of Cooling by Prof. Subhashish Chattopadhyay SKMClasses Bangalore Useful for IIT-JEE, CBSE, I.Sc. PU-II, Boards, CET, CEE, PET, IGCSE IB AP-Physics and other exams

Newton 's Law of Cooling by Prof. Subhashish Chattopadhyay SKMClasses Bangalore Useful for IIT-JEE, CBSE, I.Sc. PU-II, Boards, CET, CEE, PET, IGCSE IB AP-Physics and other exams

help of molecular biology, the first complex phylogenetic tree of this group, an interpretation of its evolution.

It shows that; the beginning of life, coincides with a hypothetical event that occurred 4 billion to 3.85 billion years ago, known as the Late Heavy Bombardment, in which asteroids pummeled Earth and the solar system's other inner planets. These impacts may have provided the energy to jumpstart the chemistry of life.

Studies suggest that asteroid impacts may break down formamide – a molecule thought to be present in early Earth's atmosphere – into genetic building blocks of DNA and its cousin RNA, called nucleobases.

Chemist Svatopluk Civiš, of the Academy of Sciences of the Czech Republic, and his colleagues used a high-powered laser to break down ionized formamide gas, or plasma, to mimic an asteroid strike on early Earth. The reaction produced scalding temperatures of up to 4,230 degrees Celsius, sending out a shock wave and spewing intense ultraviolet and X-ray radiation. The chemical fireworks produced four of the nucleobases that collectively make up DNA and RNA: adenine, guanine, cytosine and uracil.

The Amino acids joinup to make various Proteins. These lead to microbes. Stromatolites produced Oxygen, and increased the Oxygen content in the atmosphere over Billion years. The Oxygen also made Iron oxide out of Iron dissolved in Water, which deposited as layers of Iron ore.

See about Trilobites at <https://research.amnh.org/paleontology/trilobite-website/twenty-trilobite-fast-facts>

http://www.fossilmuseum.net/Tree_of_Life/Stromatolites.htm

<http://jrscience.wcp.muohio.edu/fieldcourses01/PapersMarineEcologyArticles/Stromatolites-TheLongestI.html>

Dvorák and his colleagues utilised also a genome sequence of a new genus of cyanobacteria found in a peatbog in Slovakia. It was named Neosynechococcus. Algology (from algae) is a branch of biology studying algae and cyanobacteria. It deals with the systematisation, phylogenesis, and ecology of these organisms. It also includes physiology, biochemistry, and genetics.

See <https://www.youtube.com/watch?v=SOGwoFkPtT8>

The Miller-Urey experiment was a chemical experiment that simulated the conditions thought at the time to be present on the early Earth, and tested the chemical origin of life under those conditions. Earth favoured chemical reactions that synthesized more complex organic compounds from simpler inorganic precursors. Considered to be the classic experiment investigating abiogenesis, it was conducted in 1952 by Stanley Miller, with assistance from Harold Urey, at the University of Chicago and later the University of California, San Diego. Scientists examining sealed vials preserved from the original experiments (of Stanley Miller)

Newton 's Law of Cooling by Prof. Subhashish Chattopadhyay SKMClasses Bangalore Useful for IIT-JEE, CBSE, I.Sc. PU-II, Boards, CET, CEE, PET, IGCSE IB AP-Physics and other exams

Newton 's Law of Cooling by Prof. Subhashish Chattopadhyay SKMClasses Bangalore Useful for IIT-JEE, CBSE, I.Sc. PU-II, Boards, CET, CEE, PET, IGCSE IB AP-Physics and other exams

were able to show that there were actually well over 20 different amino acids produced in Miller's original experiments.

See <https://www.youtube.com/watch?v=57mertelsBc>

In 1961, Joan Oró found that the nucleotide base adenine could be made from hydrogen cyanide (HCN) and ammonia in a water solution. His experiment produced a large amount of adenine, the molecules of which were formed from 5 molecules of HCN. Also, many amino acids are formed from HCN and ammonia under these conditions. Experiments conducted later showed that the other RNA and DNA nucleobases could be obtained through simulated prebiotic chemistry with a reducing atmosphere.

See <https://www.youtube.com/watch?v=xyhZcEY5PCQ>

Next Study Evolution

- http://evolution.berkeley.edu/evolibrary/article/side_0_0/origsoflife_05

<https://www.youtube.com/watch?v=OqG01ihQjoo>

-

There are many near Earth Asteroids; that are being constantly monitored, since 1990s. This is to avoid any major impact that may wipeout life from Earth. International cooperation exists, to plan for destroying the Asteroid which is directed towards Earth. Near-Earth asteroids are in a different class than main belt asteroids, as they are much closer energetically to Earth.

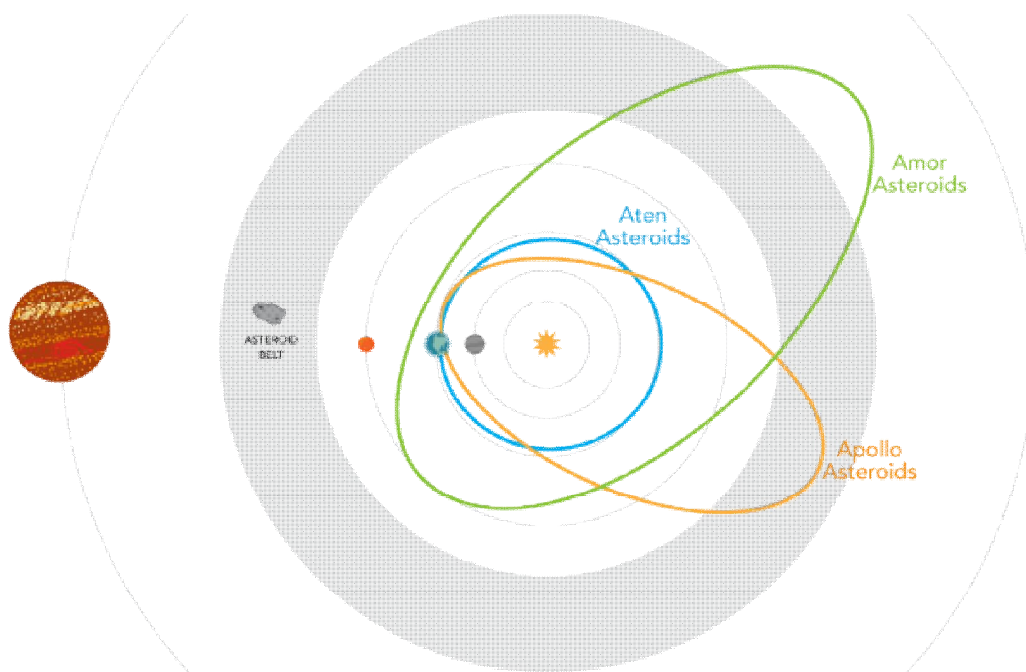

Newton 's Law of Cooling by Prof. Subhashish Chattopadhyay SKMClasses Bangalore Useful for IIT-JEE, CBSE, I.Sc. PU-II, Boards, CET, CEE, PET, IGCSE IB AP-Physics and other exams

Newton 's Law of Cooling by Prof. Subhashish Chattopadhyay SKMClasses Bangalore Useful for IIT-JEE, CBSE, I.Sc. PU-II, Boards, CET, CEE, PET, IGCSE IB AP-Physics and other exams

There are three main orbits of near-Earth asteroids: Amor, Aten, and Apollo.

Most intersect with the Earth's orbit at some point during their trip around the sun, making this the prime time to analyze them with a telescope, or even rendezvous with them on a prospecting mission with our Arkyd spacecraft.

See <http://www.planetaryresources.com/2015/10/studying-close-approaches-of-near-earth-asteroids/>

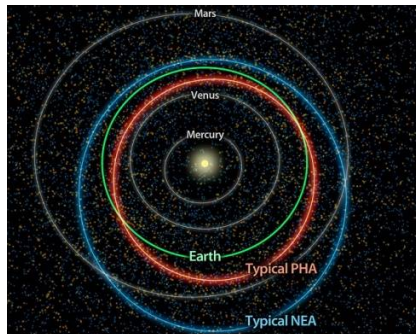

47,000 of the probable Asteroids have been listed.

<http://www.dailymail.co.uk/sciencetech/article-2145699/New-Nasa-sky-scan-reveals-47-000-hazardous-near-Earth-asteroids-330ft-wide--BIGGER.html>

Craig Venter and his team of Nobel Laureates, and other very smart Scientists, have been working on Artificial or Synthetic life for long.

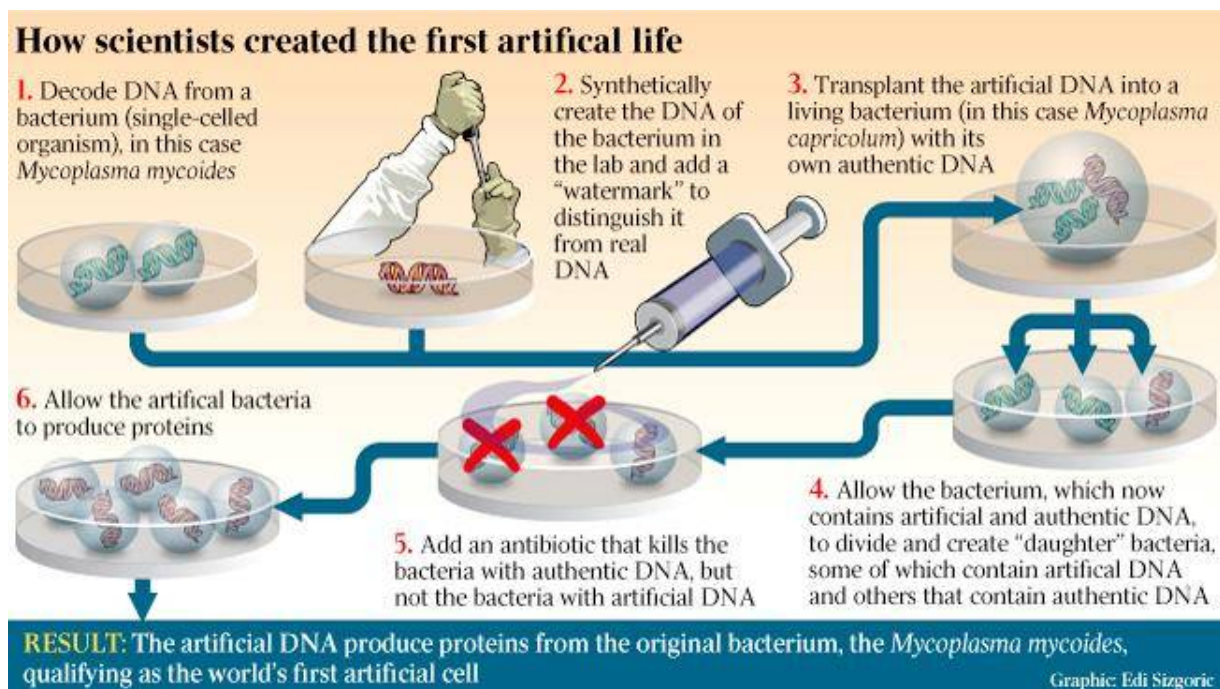

Newton 's Law of Cooling by Prof. Subhashish Chattopadhyay SKMClasses Bangalore Useful for IIT-JEE, CBSE, I.Sc. PU-II, Boards, CET, CEE, PET, IGCSE IB AP-Physics and other exams

HOW TO MAKE ARTIFICIAL LIFE

1 Entire DNA of *Mycoplasma mycoides*, a bug that usually infects goats, is decoded.

2 Researchers buy fragments of DNA from a mail order catalogue. Each of the four bottles of chemicals contains a section of the code.

3 The fragments are put into yeast, which 'stitches' them together, gradually building a synthetic copy of the original DNA.

4 The artificial DNA is put into a recipient bacterium, which then grows and divides, creating two daughter cells, one with the artificial DNA and one with the natural DNA.

5 Antibiotics in the petri dish kill the bacterium with the natural DNA, leaving the one with the synthetic DNA to multiply.

6 Within just a few hours, all traces of the recipient bug are wiped out and bugs with artificial DNA thrive. New life has been created.

7 Possible uses are bugs capable of producing clean fuels and sucking carbon dioxide out of the atmosphere. Also microbes capable of mopping up oil slicks (above) or generating drugs, including the flu vaccine.

Maverick: Dr Craig Venter

Graphic by John Lawson

Newton 's Law of Cooling by Prof. Subhashish Chattopadhyay SKMClasses Bangalore Useful for IIT-JEE, CBSE, I.Sc. PU-II, Boards, CET, CEE, PET, IGCSE IB AP-Physics and other exams

See <https://www.youtube.com/watch?v=ayfF1v7rifw>

-

Gordon Allport and S. Odbert - The OCEAN model of "Big Five personality traits", rather modern Psychology was started by these two Men. The Big Five personality traits, also known as the five factor model (FFM), is a model based on common language descriptors of personality (lexical hypothesis). These descriptors are grouped together using a statistical technique called factor analysis (i.e. this model is not based on experiments). This widely examined theory suggests five broad dimensions used by some psychologists to describe the human personality and psyche. The five factors have been defined as openness to experience, conscientiousness, extraversion, agreeableness, and neuroticism, often listed under the acronyms OCEAN or CANOE. Beneath each proposed global factor, a number of correlated and more specific primary factors are claimed. For example, extraversion is said to include such related qualities as gregariousness, assertiveness, excitement seeking, warmth, activity, and positive emotions.

In 1884, Sir Francis Galton was the first person who is known to have investigated the hypothesis that it is possible to derive a comprehensive taxonomy of human personality traits by sampling language: the lexical hypothesis. In 1936, Gordon Allport and S. Odbert put Sir Francis Galton's hypothesis into practice by extracting 4,504 adjectives which they believed were descriptive of observable and relatively permanent traits from the dictionaries at that time. In 1940, Raymond Cattell retained the adjectives, and eliminated synonyms to reduce the total to 171. He constructed a self-report instrument for the clusters of personality traits he found from the adjectives, which he called the Sixteen Personality Factor Questionnaire. Based on a subset of only 20 of the 36 dimensions that Cattell had originally discovered, Ernest Tupes and Raymond Christal claimed to have found just five broad factors which they labeled: "surgency", "agreeableness", "dependability", "emotional stability", and "culture". Warren Norman subsequently relabeled "dependability" as "conscientiousness".

After "**God, Puja & Prayer**", being the 1st ; the 2nd worst illusion, that hampers Science; is "**Gut feeling**". The Havoc or mayhem of "Gut feeling" is very prominently seen regarding Psychology, or People skills (of most people). Close to 99% people conduct interviews and take 'people decisions', without caring anything about Psychology.

Long back I wrote "**Millions of Interviews are being conducted every day, where the interviewer knows nothing about Psychology, while believes that her gut feeling is guiding for correct decisions**". [[the reader will have to agree with this, if he heard about OCEAN model for the first time, here](#)]

<https://zookeepersblog.wordpress.com/interview-techniques-and-the-things-you-cannot-find/>

<https://zookeepersblog.wordpress.com/are-people-very-logical-and-rational-then-why-should-we-be-polite-with-all/>

Newton 's Law of Cooling by Prof. Subhashish Chattopadhyay SKMClasses Bangalore Useful for IIT-JEE, CBSE, I.Sc. PU-II, Boards, CET, CEE, PET, IGCSE IB AP-Physics and other exams

Newton 's Law of Cooling by Prof. Subhashish Chattopadhyay SKMClasses Bangalore Useful for IIT-JEE, CBSE, I.Sc. PU-II, Boards, CET, CEE, PET, IGCSE IB AP-Physics and other exams

<https://zookeepersblog.wordpress.com/correlated-adjectives-this-personality-trait-predicts-your-tendency-to-lie-and-cheat/>

Psychology stands on the conclusions drawn after experiments. Some most important experiments being Milgram Experiment, Stanford Prison experiment, Hawthorne experiment, Bad Samaritan experiment, Attractiveness experiments, Evolutionary Psychology experiment, Decoy experiments, Equity theory of Motivation experiments, etc ...

The experiments that I used to talk about while teaching **Senior Corporate Managers** are listed at

<https://zookeepersblog.wordpress.com/psychology-experiments-and-summary-of-the-subject/>

-

Is Economics a Branch of Science ?

Not discussing about Economists here, as my personal opinion about, "works and contribution of Economists" is very poor. All of them argue and fancy in disagreeing with each and every thing told by someone. Economics has no consensus, no agreed rules, driven more by politics, and / or dynamic situations. No prediction by any Economist comes Correct or True; consistently. Media interviews thousands of these "strange foolish guys", and tries to "understand" an average. Randomly someone's prediction matches the actual outcome, and Predictions of 999 of the other **morons** deviate. These guys are always busy, analyzing and confirming that in past what had happened was "**inevitable**", while in the same breath, they accept that "no clue about the future". **None** had predicted the "**inevitable**" though. The stupidest of all the doomsters is Thomas Malthus. He has a "world record" of its kind, as ALL his predictions came wrong.

[The second record holder will be of course Sigmund Freud. All explanations given by Freud are wrong, and crap. Modern Psychologists, call Freud worst than a quack. See how Professor Bloom, from Yale laugh at Freud, (and I agree with Prof. Bloom), in the class...
<https://www.youtube.com/watch?v=P3FKHH2RzjI&list=PL6A08EB4EEFF3E91F>

even Aristotle did better than these stupids. See something what Aristotle said is true, given below in this book]

Personally I have read several books in Economics, and several thousand (may be more than 10,000) scholarly articles. All will call me a fool, for every prediction; I make on Economy, or anything in Economics. As usual no one will agree with me, I know. I never try to talk about Economics, as you all saw, here, just now! I agreed with Millions of others, **'to Not to** believe in anything an Economist says or predicts.

A very small "summary" of what these 'idiots' have done is at

<https://zookeepersblog.wordpress.com/a-butcher-makes-kima-of-economics/>

Newton 's Law of Cooling by Prof. Subhashish Chattopadhyay SKMClasses Bangalore Useful for IIT-JEE, CBSE, I.Sc. PU-II, Boards, CET, CEE, PET, IGCSE IB AP-Physics and other exams

Newton 's Law of Cooling by Prof. Subhashish Chattopadhyay SKMClasses Bangalore Useful for IIT-JEE, CBSE, I.Sc. PU-II, Boards, CET, CEE, PET, IGCSE IB AP-Physics and other exams

[My friends occasionally say ... "[even Russia has Russian economists](#)" ...]

Nassim Taleb has called for cancellation of the Nobel Prize in Economics, saying that the damage from economic theories can be devastating. (and I agree with him).

-

In contrast to economics, Finance Law/Rules and Marketing Tricks/Techniques are supreme. Very correctly Millions call these subjects as "Financial Science" and "Marketing Science".

The learning's here are generally not attributed to a particular person. There are many Key concepts, which are correct; and accurate! These enable people to take right decisions, to make money, be profitable, to generate employment, to avoid and reduce loss, to sale, and keep businesses going.

For whatever we do, we have to deal with people, and earn money or make profit. So the basic understanding of Psychology, the Laws of Finance, and the 'Tricks and trades' of Marketing (Science) are must for all. Human beings in general, harbor many limitations; which Economists disregard. One of the first assumptions of Economics, "The Rational Human beings" is wrong.

See the list of Biases at <http://skmclasses.kinja.com/bias-we-all-are-biased-1761664826>

Some of the key concepts of Finance are NPV (Net Present Value), ROI (Return on Investment), Risk/Return Tradeoff, Diversification, ROCE (Return on Capital Employed), Discounted Cash flow, Time value of Money, Liquidity, Budgeting etc. The list is big. It takes many months of correct studies, to understand and master these. Those who apply these rules and learning's well; are paid well. People in general do not disagree to fight with what Finance Gurus says.

It is extremely important for every student to know that everyone is not working or running after profit, or ROI. The world is full with Philanthropic acts. There are Billions of Altruists. Too much of priority towards money, makes people cold, cruel, isolated, un-helping, and in-human ...

See <https://zookeepersblog.wordpress.com/do-you-know-who-was-dashrath-manjhi/>

-

Marketing Science is **Art**. Successful Marketing gurus are paid very well. I have not seen insults and fights, towards Marketing Gurus. [People just do not hate them like Economists.](#) There are some key concepts.

See <https://zookeepersblog.wordpress.com/25-points-on-brand-and-marketing/>

Personally I will always remain a toddler, regarding Tricks and details of Marketing.

Newton 's Law of Cooling by Prof. Subhashish Chattopadhyay SKMClasses Bangalore Useful for IIT-JEE, CBSE, I.Sc. PU-II, Boards, CET, CEE, PET, IGCSE IB AP-Physics and other exams

Newton 's Law of Cooling by Prof. Subhashish Chattopadhyay SKMClasses Bangalore Useful for IIT-JEE, CBSE, I.Sc. PU-II, Boards, CET, CEE, PET, IGCSE IB AP-Physics and other exams

When I was in Standard 9, my Aunt (Cousin sister of my Mom), started a very small chemical business. She was staying in a different city, and I “managed” the business affairs, in Jamshedpur. I had to meet lot of people at various offices, advertise, give sale pitches, sale, follow-up with people, get payments, and generate profit etc.

This gave me very interesting exposure to human behavior, organizations, processes, human nature and follies, greed etc. Much later I managed my own IIT JEE coaching / Business.

With this background, I am adding “**a Pinch of Salt**” in the **Ocean of Management**.

[meaning, I do not think, my words are going to teach or contribute anything]



Regarding advertisement, I have observed that people are in silos, or islands. Mostly unaware what is going on in other islands. People expect advertisement in their own silo, or island. So advertisement is required to be done in multiple mediums / channels. If I advertise in newspaper, (say about Govt. of India, official Olympiads), some people will say ... “school did not tell anything” . If I advertise in Google adwords, guys in Facebook will not know. Any amount of “Radio Messages” done, will not stop people saying ... “the CSR (corporate Social responsibility) department did not send any mailer ! ...



It is extremely costly to advertise in every island. Small businesses just cannot afford such expenditures. So advertisement always remains insufficient, as per my perception. Effectiveness of the advertisements, and success is always unknown. As per my perception, the young MBA's handling the budget randomly try various things, playing randomly with “others money” . Randomly there is some result/response, that is termed / “show cased” as

Newton 's Law of Cooling by Prof. Subhashish Chattopadhyay SKMClasses Bangalore Useful for IIT-JEE, CBSE, I.Sc. PU-II, Boards, CET, CEE, PET, IGCSE IB AP-Physics and other exams

Newton 's Law of Cooling by Prof. Subhashish Chattopadhyay SKMClasses Bangalore Useful for IIT-JEE, CBSE, I.Sc. PU-II, Boards, CET, CEE, PET, IGCSE IB AP-Physics and other exams

success. Gurus handling crores of advertisement budget will have their own "correct" experience. 99.99% people / small businesses are not relevant in that.

[Google adwords in my experience or observation; is very costly, and not at all effective. Adwords is absolute waste of money. Facebook in contrast maintains lots of connections, the visitors repeat of their own, so much more persistent.]

As per my perception; Advertisement is not a communication, at all. It is an enabler, so that **if someone searches**, then can find the links / details quickly. Only those who search, if they get some details, of something; earlier than another; the former has higher chance being considered.

[Did you notice that top 50 or 100 Management Gurus, and / or "Best selling Management Books" are not Indian]

-

Science is closely related to Technology. I personally cannot distinguish.

3D Printing was started by Chuck Hull



As of 2016 (apart from Lakhs of Industrial Applications) Body-parts are being 3D printed

See <https://www.youtube.com/watch?v=a1lkv3yHs0w>

And https://www.youtube.com/watch?v=_RO5DSIB1GE

Newton 's Law of Cooling by Prof. Subhashish Chattopadhyay SKMClasses Bangalore Useful for IIT-JEE, CBSE, I.Sc. PU-II, Boards, CET, CEE, PET, IGCSE IB AP-Physics and other exams

Newton 's Law of Cooling by Prof. Subhashish Chattopadhyay SKMClasses Bangalore Useful for IIT-JEE, CBSE, I.Sc. PU-II, Boards, CET, CEE, PET, IGCSE IB AP-Physics and other exams

Xenotransplantation

<https://www.youtube.com/watch?v=6rKUBBjaa0g>

<https://www.youtube.com/watch?v=qFOo28AahAE>

-

Artificial Blood

Since 1990s various kinds of Artificial Blood has been made. I read many reports! Research to improve is always on.

<https://www.youtube.com/watch?v=9I7oUuZBG4c>

-

Artificial Photosynthesis or Chlorophyll

<https://www.youtube.com/watch?v=hU-T0ht2OdQ>

<https://www.youtube.com/watch?v=N8LHqoNber4>

-

Nanotechnology

<https://www.youtube.com/watch?v=xIYlex2TF5g>

<https://www.youtube.com/watch?v=7hRjhxi2uL0>

-

Metamaterials

<https://www.youtube.com/watch?v=taSfueSfmag>

https://www.youtube.com/watch?v=26J5n_8_6TQ

-

Molecular Motors

<https://www.youtube.com/watch?v=WH5rwsu5tzl>

-

Quantum Computer

<https://www.youtube.com/watch?v=0dXNmbiGPS4>

<https://www.youtube.com/watch?v=u9zx7QOKPno>

Newton 's Law of Cooling by Prof. Subhashish Chattopadhyay SKMClasses Bangalore Useful for IIT-JEE, CBSE, I.Sc. PU-II, Boards, CET, CEE, PET, IGCSE IB AP-Physics and other exams

Newton 's Law of Cooling by Prof. Subhashish Chattopadhyay SKMClasses Bangalore Useful for IIT-JEE, CBSE, I.Sc. PU-II, Boards, CET, CEE, PET, IGCSE IB AP-Physics and other exams

For list of emerging Technologies see

https://en.wikipedia.org/wiki/List_of_emerging_technologies

-

Bio-batteries: creating energy from bacteria (or Microbial Fuel Cell)

Research reported by Dr Tom Clarke's team at the University of East Anglia's Department of Biological Sciences has shown how thousands of tiny molecular wires embedded in the surface of a bacterium called *Shewanella oneidensis* can directly transmit an electric current to inorganic minerals such as iron and manganese oxides, or the surface of electrodes. The phenomenon, known as direct extracellular electron transfer (DEET), occurs because of the way that some bacteria living in environments lacking oxygen export electrons that are generated through their respiratory cycle. Examples include *Shewanella*, and some species of another bacterium known as *Geobacter*.

See <http://eandt.theiet.org/magazine/2013/07/growing-power.cfm>

Regarding Indian Scientists <https://journosdiary.com/2016/09/10/iisc-india-bacteria-power-tiny-engine/>

-

Communication in trees

Trees, it turns out, have a completely different way of communicating: they **use scent**. Four decades ago, scientists noticed something on the African savannah. The giraffes there were feeding on umbrella thorn acacias, and the trees didn't like this one bit. It took the acacias mere minutes to start pumping toxic substances into their leaves to rid themselves of the large herbivores. The giraffes got the message and moved on to other trees in the vicinity. But did they move on to trees close by? No, for the time being, they walked right by a few trees and resumed their meal only when they had moved about 100 yards away.

The acacia trees that were being eaten gave off a warning gas (specifically, ethylene) that signaled to neighbouring trees of the same species that a crisis was at hand. Right away, all the forewarned trees also pumped toxins into their leaves to prepare themselves. The giraffes were wise to this game and therefore moved farther away to a part of the savannah where they could find trees that were oblivious to what was going on. Or else they moved upwind. For the scent messages were carried to nearby trees on the breeze, and if the animals walked upwind, they could find acacias close by that had no idea the giraffes were there.

This ability to produce different compounds is another feature that helps trees fend off attack for a while. When it comes to some species of insects, trees can accurately identify which bad guys they are up against. The saliva of each species is different, and the tree can match the saliva to the insect. Indeed, the match can be so precise that the tree can release pheromones that summon specific beneficial predators. The beneficial predators help the

Newton 's Law of Cooling by Prof. Subhashish Chattopadhyay SKMClasses Bangalore Useful for IIT-JEE, CBSE, I.Sc. PU-II, Boards, CET, CEE, PET, IGCSE IB AP-Physics and other exams

Newton 's Law of Cooling by Prof. Subhashish Chattopadhyay SKMClasses Bangalore Useful for IIT-JEE, CBSE, I.Sc. PU-II, Boards, CET, CEE, PET, IGCSE IB AP-Physics and other exams

tree by eagerly devouring the insects that are bothering them. For example, elms and pines call on small parasitic wasps that lay their eggs inside leaf-eating caterpillars. As the wasp larvae develop, they devour the larger caterpillars bit by bit from the inside out. Not a nice way to die. The result, however, is that the trees are saved from bothersome pests and can keep growing with no further damage. The fact that trees can recognize saliva is, incidentally, evidence for yet another skill they must have. For if they can identify saliva, they must also have a sense of taste.

A drawback of scent compounds is that they disperse quickly in the air. Often they can only be detected within a range of about 100 yards. Quick dispersal, however, also has advantages. As the transmission of signals inside the tree is very slow, a tree can cover long distances much more quickly through the air if it wants to warn distant parts of its own structure that danger lurks. A specialized distress call is not always necessary when a tree needs to mount a defence against insects. The animal world simply registers the tree's basic **chemical alarm call**. It then knows some kind of attack is taking place and predatory species should mobilize. Whoever is hungry for the kinds of critters that attack trees just can't stay away.

Trees can also mount their own defence. **Oaks, for example, carry bitter, toxic tannins in their bark and leaves**. These either kill chewing insects outright or at least affect the leaves' taste to such an extent that instead of being deliciously crunchy, they become biliously bitter. Willows produce the defensive compound salicylic acid, which works in much the same way. But not on us. Salicylic acid is a precursor of aspirin, and tea made from willow bark can relieve headaches and bring down fevers. Such defence mechanisms, of course, take time. Therefore, a combined approach is crucially important for arboreal early-warning systems.

Trees also warn each other using chemical signals sent through the fungal networks around their root tips. which operate no matter what the weather. Surprisingly, news bulletins are sent via the roots not only by means of chemical compounds but also by means of electrical impulses that travel at the speed of a third of an inch per second. In comparison with our bodies, it is, admittedly, extremely slow. However, there are species in the animal kingdom, such as jellyfish and worms, whose nervous systems conduct impulses at a similar speed. Once the latest news has been broadcast, all oaks in the area promptly pump tannins through their veins.

Tree roots extend a long way, more than twice the spread of the crown. So the root systems of neighbouring trees inevitably intersect and grow into one another—though there are always some exceptions. Even in a forest, there are loners, would-be hermits who want little to do with others. Can such antisocial trees block alarm calls simply by not participating? Luckily, they can't. For usually **there are fungi present that act as intermediaries to guarantee quick dissemination of news**. These fungi operate like fibre-optic Internet cables. Their thin filaments penetrate the ground, weaving through it in almost unbelievable density. One teaspoon of forest soil contains many miles of these 'hyphae'. Over centuries, a single fungus can cover many square miles and network an entire forest. The fungal connections transmit signals from one tree to the next, helping the trees exchange news about insects, drought,

Newton 's Law of Cooling by Prof. Subhashish Chattopadhyay SKMClasses Bangalore Useful for IIT-JEE, CBSE, I.Sc. PU-II, Boards, CET, CEE, PET, IGCSE IB AP-Physics and other exams

Newton 's Law of Cooling by Prof. Subhashish Chattopadhyay SKMClasses Bangalore Useful for IIT-JEE, CBSE, I.Sc. PU-II, Boards, CET, CEE, PET, IGCSE IB AP-Physics and other exams

and other dangers. Science has adopted a term first coined by the journal Nature for **Simard**'s discovery of the 'wood wide web' pervading our forests. What and how much information is exchanged are subjects we have only just begun to research. For instance, **Suzzane Simard** discovered that [different tree species are in contact with one another](#), even when they regard each other as competitors. And the fungi are pursuing their own agendas and appear to be very much in favour of conciliation and equitable distribution of information and resources.

If trees are weakened, it could be that they lose their conversational skills along with their ability to defend themselves. Otherwise, it's difficult to explain why insect pests specifically seek out trees whose health is already compromised. It's conceivable that to do this, insects listen to trees' urgent chemical warnings, and then test trees that don't pass the message on by taking a bite out of their leaves or bark. A tree's silence could be because of a serious illness or, perhaps, the loss of its fungal network, which would leave the tree completely cut off from the latest news. The tree no longer registers approaching disaster, and the doors are open for the caterpillar and beetle buffet. The loners I just mentioned are similarly susceptible—they might look healthy, but they have no idea what is going on around them.

In the symbiotic community of the forest, not only trees but also shrubs and grasses—and possibly all plant species—exchange information this way. However, when we step into farm fields, the vegetation becomes very quiet. Thanks to selective breeding, our cultivated plants have, for the most part, lost their ability to communicate above or below ground—you could say they are deaf and dumb—and therefore they are easy prey for insect pests. That is one reason why modern agriculture uses so many pesticides. Perhaps farmers can learn from the forests and breed a little more wildness back into their grain and potatoes so that they'll be more talkative in the future...

To decide if trees are silent ... researchers substitute grain seedlings because they are easier to handle. They started listening, and it didn't take them long to discover that their measuring apparatus was registering roots crackling quietly at a frequency of 220 hertz. Crackling roots? That doesn't necessarily mean anything. After all, even dead wood crackles when it's burned in a stove. But the noises discovered in the laboratory caused the researchers to sit up and pay attention. For the roots of seedlings not directly involved in the experiment reacted. Whenever the seedlings' roots were exposed to a crackling at 220 hertz, they oriented their tips in that direction. That means the grasses were registering this frequency, so it makes sense to say they 'heard' it.

[It is well known that Music Played near trees help them grow faster. There are many commercial products claiming quicker growth in farms.](#)

After reading all these some may imagine that this is what is happening in jungles

Newton 's Law of Cooling by Prof. Subhashish Chattopadhyay SKMClasses Bangalore Useful for IIT-JEE, CBSE, I.Sc. PU-II, Boards, CET, CEE, PET, IGCSE IB AP-Physics and other exams

How trees are made



-

The list can go on forever. Students can read and learn more of their own...

-

Newton 's Law of Cooling by Prof. Subhashish Chattopadhyay SKMClasses Bangalore Useful for IIT-JEE, CBSE, I.Sc. PU-II, Boards, CET, CEE, PET, IGCSE IB AP-Physics and other exams

Even though Indian Rocket could send 20 Satellites to space in one go, Indian prefer to do the following ...



Every Puja is remnant of "Caste System". Think ... Who are performing the Pujas ? What is the Qualification of the Pujari ? What is his effectiveness ? How are the Pujaris chosen ?

Russian Dnepr rocket had sent **37 satellites** to Space, without Pujas !

I have met lot of people who think, that "Global Warming" is happening due to Cars, or because of burning Plastics ...

In our atmosphere close to 1% is Argon, while only 0.04% in CO₂

Half of the world's oxygen is produced via phytoplankton photosynthesis. The other half is produced via photosynthesis on land by trees, shrubs, grasses, and other plants.

See http://news.nationalgeographic.com/news/2004/06/0607_040607_phytoplankton.html

See <http://skmclasses.kinja.com/global-warming-is-not-due-to-human-activity-1761784651>

My students and the readers of this book must know that; over the past 250 years, humans have added just one part of CO₂ in 10,000 to the atmosphere. One volcanic cough can do this in a day. <https://www.skepticalscience.com/print.php?r=50>

<http://time.com/3698572/science-maya-tolstoy-geophysical-research-letters-volcanoes-climate-change/>

Temperature-Sea Levels-CO₂-etc always have been fluctuating over ages - Global Warming

See

<https://archive.org/details/TemperatureSeaLevelsCO2EtcAlwaysHaveBeenFluctuatingOverAgesGlobalWarming>

Newton 's Law of Cooling by Prof. Subhashish Chattopadhyay SKMClasses Bangalore Useful for IIT-JEE, CBSE, I.Sc. PU-II, Boards, CET, CEE, PET, IGCSE IB AP-Physics and other exams

Newton 's Law of Cooling by Prof. Subhashish Chattopadhyay SKMClasses Bangalore Useful for IIT-JEE, CBSE, I.Sc. PU-II, Boards, CET, CEE, PET, IGCSE IB AP-Physics and other exams

Know about the Giants of Science from Videos

<https://archive.org/details/CasimirPolderDaviesUnruhBELLAspectGalileoMosleyChadwickFeynmanSchrodinger>

<https://www.youtube.com/watch?v=ecQazN9Z24w>

Long back a Professor had advised me, to read all issues of Scientific American; say from 1920s, or as old as possible; to learn Physics. I did listen to him and read all old copies, that were available in the Library. Now in the net it is much easier for Students, to get the copies.

See [https://archive.org/search.php?query="Scientific%20American"](https://archive.org/search.php?query=)

In 1999 there was a Special Issue on Men

See <https://archive.org/stream/ScientificAmericanspEd-Vol10No2-Men-1999#page/n1/mode/2up>



Newton 's Law of Cooling by Prof. Subhashish Chattopadhyay SKMClasses Bangalore Useful for IIT-JEE, CBSE, I.Sc. PU-II, Boards, CET, CEE, PET, IGCSE IB AP-Physics and other exams

Newton 's Law of Cooling by Prof. Subhashish Chattopadhyay SKMClasses Bangalore Useful for IIT-JEE, CBSE, I.Sc. PU-II, Boards, CET, CEE, PET, IGCSE IB AP-Physics and other exams

Preface for Physics

Professor H. C. Verma wrote amazing books in Physics. There are many other good books for IIT JEE and other exams. [Krishna's Guides](#), Books by Professor [N. N. Ghosh](#), Professor D. C. Pandey, GRB Publications Physics Guides etc are very good. For numerical s the Irodov's books remain the King !

"Concepts of Physics" by Professor H C Verma have been available since 1991. (and did not change or updated since). Previous to that, past papers of IIT JEE, and other exams, were the source for preparation. I was in High School in 1980s. I had 6-7 Russian books apart from Irodov. All these were very good. Resnick and Halliday 's (Walker and Krane came in subsequently) book was also well known. There were too many " uncles " who used to advice that " only Resnick and Halliday 's book was enough " !

Well I agreed and disagreed. There were many IIT JEE questions which were ditto or verbatim picked-up from Resnick Halliday ! **But, something more was always needed.** Brilliant Tutorials, Agarwal Coaching etc, were famous those days. (1980s 90 s). They were giving **several new questions**, which enabled more practice. **People slowly realized that " every type " of questions are NOT there in Resnick & Halliday, or say Irodov.**

Uncles saying " only Resnick and Halliday 's book was enough " ! were wrong. "Concepts of Physics" by Professor H C Verma sold so much because of very good step by step explanations, new solved examples, new exercises. Several gaps were filled-up.

The word Physics is derived from Latin **physica**, from Greek (ta) **phusika**, **(the things) of nature**, from neuter plural of phusikos.

So, why am I writing "another book" in Physics ? (The description of nature)

I wish to answer this most important question, first !

There are many kind of Questions which are **not** covered in " Concepts of Physics " of Professor H. C. Verma. Also Irodov, in his books, **does not** explain or cover several kinds of Problems or Questions. The " Coaching Institutes " very rightly thrived on these gaps. Almost 100% students benefit more **with more examples**. **As Coaching Institutes discuss, cover and repeat several more examples in each chapter compared to School or Text books; explains the reason of their popularity.**

Newton 's Law of Cooling by Prof. Subhashish Chattopadhyay SKMClasses Bangalore Useful for IIT-JEE, CBSE, I.Sc. PU-II, Boards, CET, CEE, PET, IGCSE IB AP-Physics and other exams

Let me list a few examples to explain all this.

Optics - 1) The expression for deviation of a ray passing through a slab

Refraction through a transparent slab (lateral shift)

Consider a transparent slab of thickness t , and refractive index n . A monochromatic beam of light falls on one side at an angle of incidence i as shown in Fig. Emergent ray will be parallel to incident ray, but there will be a lateral shift S of the incident ray. At the first interface,

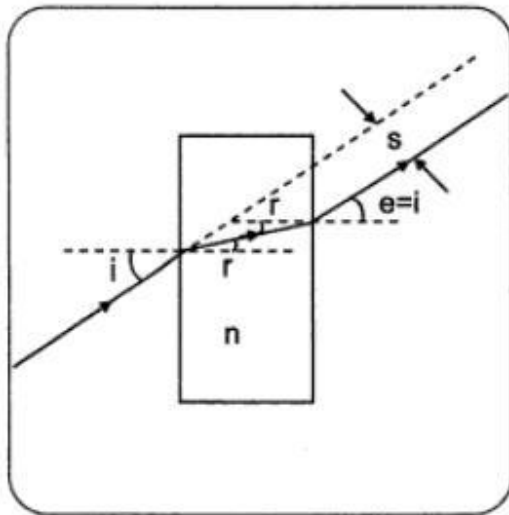

$1 \sin i = n \sin r$ and at the second interface

$n \sin r = 1 \sin e$

where, r is the angle of refraction at the first interface and e , the angle of refraction at the second interface. $\therefore e = i$

Newton 's Law of Cooling by Prof. Subhashish Chattopadhyay SKMClasses Bangalore Useful for IIT-JEE, CBSE, I.Sc. PU-II, Boards, CET, CEE, PET, IGCSE IB AP-Physics and other exams

From Fig. lateral shift is calculated as follows:

$$AD = t; AB = \frac{AD}{\cos r} = \frac{t}{\cos r}$$

$$\text{Lateral shift } S = BC = AB \sin (i - r) = \frac{t \sin(i - r)}{\cos r}$$

$$\text{i.e., } S = \frac{t \sin(i - r)}{\cos r}$$

It may be noted that $S_{\max} = t$ for $i = 90^\circ$ (grazing incidence) and $S_{\min} = 0$ for $i = 0$ (normal incidence)

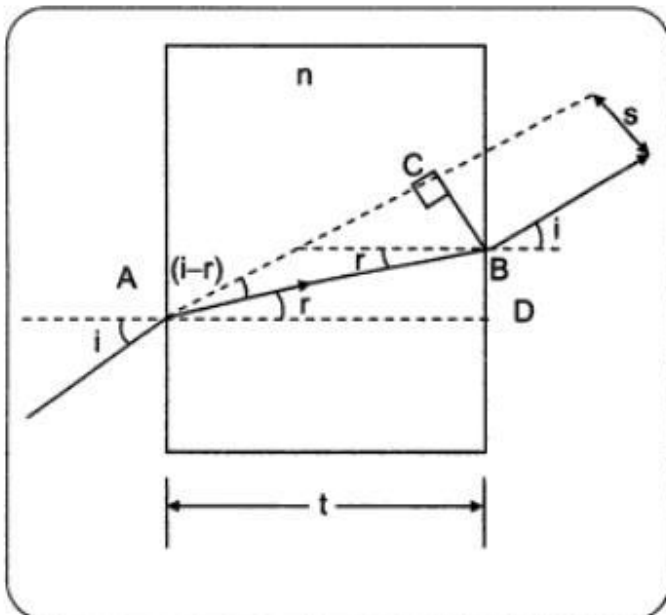

Newton 's Law of Cooling by Prof. Subhashish Chattopadhyay SKMClasses Bangalore Useful for IIT-JEE, CBSE, I.Sc. PU-II, Boards, CET, CEE, PET, IGCSE IB AP-Physics and other exams

Special case:

(i) **small i**

$$t \frac{\sin(i - r)}{\cos r} = \frac{t[\sin i \cos r - \cos i \sin r]}{\cos r}$$

$$[r \text{ small} \Rightarrow \cos r \approx 1] ; i \text{ small} \Rightarrow \cos i \approx 1]$$

$$\therefore S = t(\sin i - \sin r) = t \sin i \left[1 - \frac{\sin r}{\sin i} \right]$$

$$\Rightarrow S = t \sin i \left[1 - \frac{1}{n} \right] = t i \left(1 - \frac{1}{n} \right) [i \text{ small} \Rightarrow \sin i = i]$$

$$\Rightarrow S = t i \frac{(n - 1)}{n}$$

(Note: use formula $S = t \frac{\sin(i - r)}{\cos r}$ unless it is given that $i = \text{small}$)

(ii) When i is not small, it can be shown that

$$S = \frac{t \sin(i - r)}{\cos r} = t \sin i \left[1 - \frac{\cos i}{\sqrt{n^2 - \sin^2 i}} \right] \text{ or}$$

$$S = t \sin i \left[1 - \sqrt{\frac{1 - \sin^2 i}{n^2 - \sin^2 i}} \right]$$

See again

Lateral Shift

In the following figure, ray MA is parallel to ray BN . But the emergent ray is displaced laterally by a distance d which depends upon μ , t and i and its value is given by

$$d = t \left(1 - \frac{\cos i}{\sqrt{\mu^2 - \sin^2 i}} \right) \sin i.$$

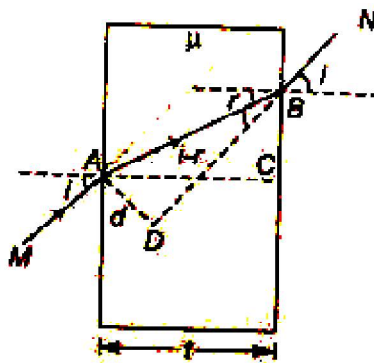

From the figure, $AB = \frac{AC}{\cos r} = \frac{t}{\cos r}$ (as, $AC = t$)

Since,

$$d = AB \sin(i - r)$$

$$= \frac{t}{\cos r} [\sin i \cos r - \cos i \sin r]$$

Further,

$$\mu = \frac{\sin i}{\sin r} \text{ or } \sin r = \frac{\sin i}{\mu}$$

\therefore

$$\tan r = \frac{\sin i}{\sqrt{\mu^2 - \sin^2 i}}$$

The expression for d now is

$$d = \left(\sqrt{1 - \frac{\cos^2 i}{\mu^2 - \sin^2 i}} \right) t \sin i$$

Note For small angles of incidence $d = t \left(\frac{\mu - 1}{\mu} \right)$

A white light is incident at 20° on a material of silicate flint glass slab as shown. $\mu_{\text{violet}} = 1.66$ and $\mu_r = 1.6$. For what value of d will the separation be 1 mm in red and violet rays.

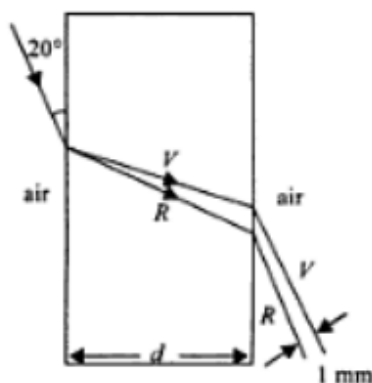

- (a) $\frac{5}{3}$ cm (b) $\frac{10}{3}$ cm
 (c) 5 cm (d) $\frac{20}{3}$ cm

Solution (b) $\sin r_1 = \frac{\sin 70}{1.66} = \frac{.9397}{1.66}$ or $r_1 = 34^\circ 30'$

$$\sin r_2 = \frac{\sin 70}{1.6} = \frac{.9397}{1.6} \text{ or } r_2 = 36^\circ$$

Using $y = \frac{t \sin(i-r)}{\cos r}$

$$y_1 - y_2 = d \left[\frac{\sin(i-r_1)}{\cos r_1} - \frac{\sin(i-r_2)}{\cos r_2} \right]$$

$$0.1 = d \left[\frac{\sin 35^\circ 30'}{\cos 34^\circ 30'} - \frac{\sin 34^\circ}{\cos 36^\circ} \right]$$

Newton's Law of Cooling by Prof. Subhashish Chattopadhyay SKMClasses Bangalore Useful for IIT-JEE, CBSE, I.Sc. PU-II, Boards, CET, CEE, PET, IGCSE IB AP-Physics and other exams

$$\text{or } 0.1 = d \left[\frac{0.5807}{0.8241} - \frac{0.5592}{0.8090} \right] = d[0.71 - 0.68]$$

$$\text{or } d = \frac{0.1}{0.03} = \frac{10}{3} \text{ cm}$$

Optics - 2) Fresnel's Biprism

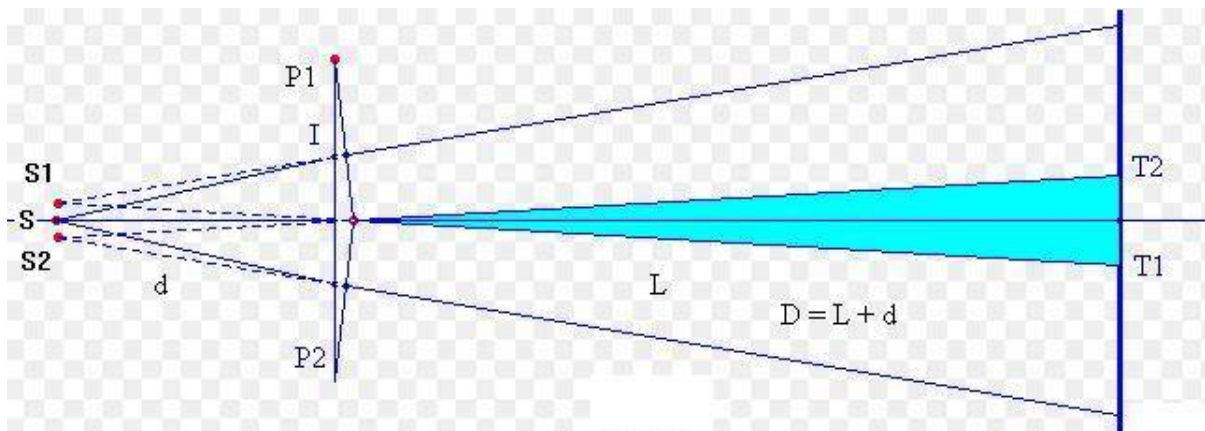
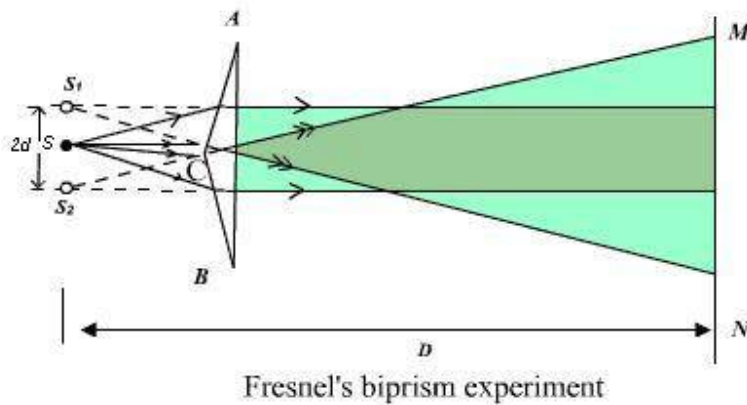
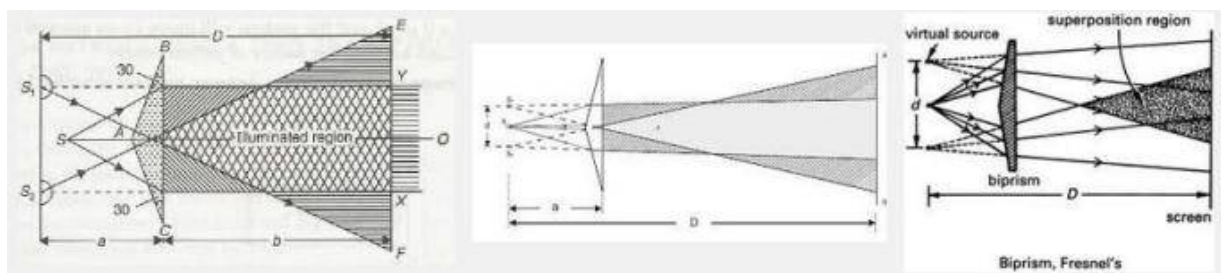

Newton's Law of Cooling by Prof. Subhashish Chattopadhyay SKMClasses Bangalore Useful for IIT-JEE, CBSE, I.Sc. PU-II, Boards, CET, CEE, PET, IGCSE IB AP-Physics and other exams

very small refracting angle α , is given by

$$\delta = (\mu - 1)\alpha,$$
 where μ is the refractive index of the material of prism. Note that α is in radian
 It is clear from Fig. that

$$\delta = \frac{d}{a}$$

$$\therefore (\mu - 1)\alpha = \frac{d}{a} \quad \text{or} \quad d = (\mu - 1)\alpha a$$

$$\therefore \boxed{2d = 2(\mu - 1)\alpha a}$$

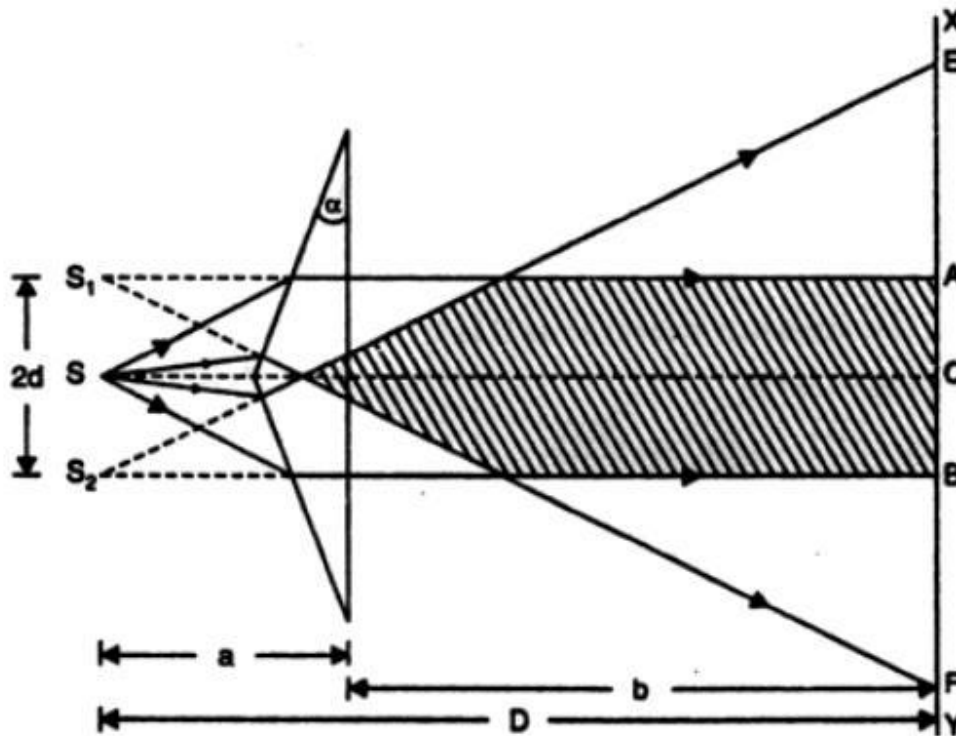
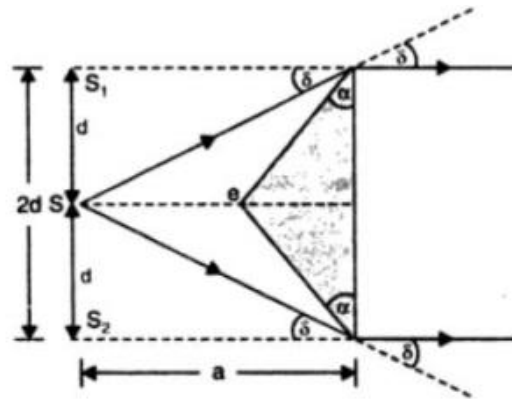

In a biprism experiment, the eye-piece was placed at a distance of 120 cm from the source. The distance between two virtual images was found equal to 0.075 cm. Find the wavelength of light of source if eye-piece is moved through a distance of 1.888 cm for 20 fringes to cross the field of view.

$$D = 120 \text{ cm,}$$

$$2d = 0.075 \text{ cm, } \lambda = ?$$

$$\beta = \frac{1.888}{20} \text{ cm}$$

$$\beta = \frac{\lambda D}{2d} \quad \text{or} \quad \lambda = \frac{\beta(2d)}{D} \text{ cm}$$

$$\lambda = \frac{1.888}{20} \times 0.075 \text{ cm}$$

$$= \frac{1.888}{120} \text{ cm}$$
$$= 5900 \times 10^{-8} \text{ cm} = \mathbf{5900 \text{ \AA}}$$

The inclined faces of a glass prism ($\mu = 1.5$) make an angle of 1° with the base of the prism. The slit is 10 cm from the biprism and is illuminated by light of $\lambda = 5900 \text{ \AA}$. Find the fringe width observed at a distance of 1m from the biprism.

Solution. $\alpha = 1^\circ = \frac{\pi}{180}$ radian,

$$\mu = 1.5,$$

$$D = 10 \text{ cm} + 100 \text{ cm} = 110 \text{ cm,}$$

$$\lambda = 5900 \times 10^{-8} \text{ cm}$$

$$\beta = \frac{D\lambda}{2d} = \frac{D\lambda}{2(\mu - 1) \alpha a}$$

or
$$\beta = \frac{110 \times 5900 \times 10^{-8} \times 7 \times 180}{2(1.5 - 1) 22 \times 10} \text{ cm}$$

$$= \mathbf{0.037 \text{ cm.}}$$

A biprism is placed 5 cm from a slit illuminated by sodium light ($\lambda = 5890 \text{ \AA}$). The width of the fringes obtained on a screen 75 cm from the biprism is $9.424 \times 10^{-2} \text{ cm}$. What is the distance between the two coherent sources ?

Solution. $D = 5 \text{ cm} + 75 \text{ cm} = 80 \text{ cm}$
 $\beta = 9.424 \times 10^{-2} \text{ cm}$
 $2d = ?$

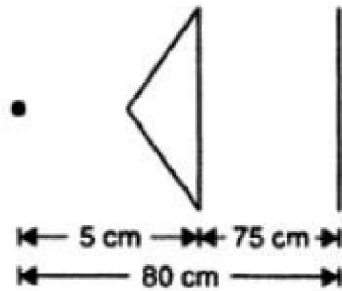

Fig. 2.25

$$\lambda = 5890 \text{ \AA} = 5890 \times 10^{-8} \text{ cm}$$

We know that $\beta = \frac{\lambda D}{2d}$

or
$$2d = \frac{\lambda D}{\beta} = \frac{5890 \times 10^{-8} \times 80}{9.424 \times 10^{-2}} \text{ cm}$$

$$= 0.05 \text{ cm.}$$

In a Fresnel's biprism experiment, the fringe width is observed to be 0.087 mm. What will it become if the slit to biprism distance is reduced to $\frac{3}{4}$ of the original distance ? (all else remaining unchanged).

Solution. $2d = 2(\mu - 1) \alpha a$... (1)

$$2d' = 2(\mu - 1) \alpha \left(\frac{3}{4} a \right) \quad \dots (2)$$

Dividing (2) by (1), $\frac{2d'}{2d} = \frac{3}{4}$

Again, we know that $\beta = \frac{D\lambda}{2d}$

$$\frac{\beta'}{\beta} = \frac{2d}{2d'} = \frac{4}{3}$$

or $\beta' = \frac{4}{3} \beta = \frac{4}{3} \times 0.087 \text{ mm} = \mathbf{0.116 \text{ mm.}}$

The inclined faces of biprism of refractive index 1.50 make angles of 2° with its base. A slit illuminated by monochromatic light is placed at a distance of 10 cm from the biprism. If

distance between two dark fringes observed at a distance of 1 metre from biprism is 0.18 mm, find the wavelength of light used.

Solution. $\mu = 1.50,$

$$\alpha = 2^\circ = 2 \times \frac{\pi}{180} = \frac{\pi}{90} \text{ radian,}$$

$$a = 10 \text{ cm, } b = 1 \text{ m} = 100 \text{ cm,}$$

$$\beta = 0.18 \text{ mm} = 0.018 \text{ cm, } \lambda = ?$$

We know that

$$\beta = \frac{D\lambda}{2d}, D = a + b \text{ and } 2d = 2(\mu - 1)\alpha a$$

$$\therefore \beta = \frac{\lambda(a + b)}{2(\mu - 1)\alpha a}$$

$$\therefore \lambda = \frac{2\beta(b - 1)\alpha a}{a + b}$$

$$\begin{aligned} &= \frac{2 \times 0.018 \times (1.50 - 1) \frac{\pi}{90} \times 10}{10 + 100} \text{ cm} \\ &= 5714 \times 10^{-8} \text{ cm} = \mathbf{5714 \text{ \AA}.} \end{aligned}$$

If Fresnel biprism is immersed in a liquid of refractive index μ' , then

$$\beta_{new} = \frac{\frac{\lambda}{\mu'}(a + b)}{2a\left(\frac{\mu}{\mu'} - 1\right)\alpha} = \frac{\lambda(a + b)}{2a(\mu - \mu')\alpha}$$

Newton 's Law of Cooling by Prof. Subhashish Chattopadhyay SKMClasses Bangalore Useful for IIT-JEE, CBSE, I.Sc. PU-II, Boards, CET, CEE, PET, IGCSE IB AP-Physics and other exams

Optics - 3) Negative Refractive Index. For meta-materials we can have Negative Refractive index. So " Refractive Index " is a ' rare ' scalar which can be negative. [Recall most scalars are positive, such as volume, mass, pressure, viscosity, resistance, inductance, capacitance etc. **Can you think of a few scalars which can be negative also apart from charge or current ?**]

Negative refractive index question was asked in 2012 IIT JEE

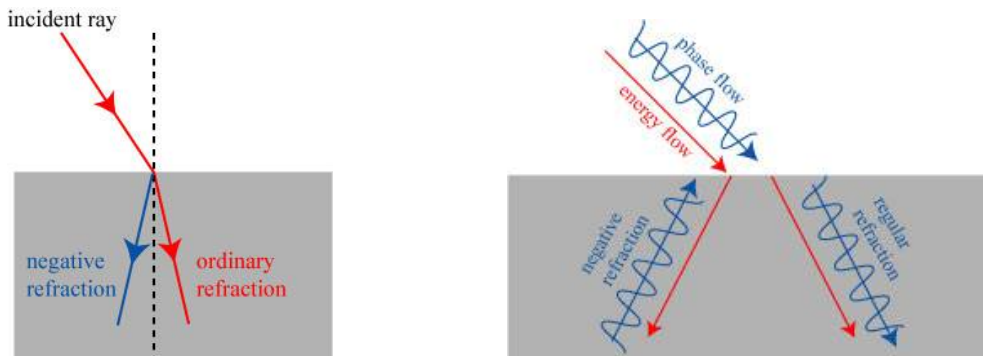

Optics - 4) Combination of Prism and Mirror problems

Find the co-ordinates of image of the point object 'O' formed after reflection from concave mirror as shown in figure assuming prism to be thin and small in size of prism angle 2° . Refractive index of the prism material is $3/2$.

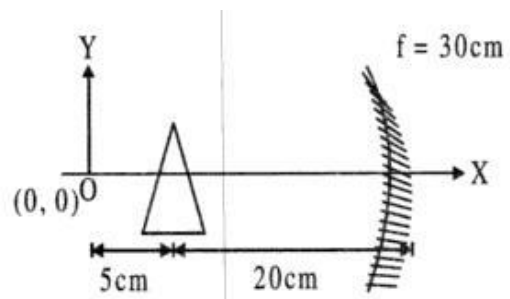

Newton 's Law of Cooling by Prof. Subhashish Chattopadhyay SKMClasses Bangalore Useful for IIT-JEE, CBSE, I.Sc. PU-II, Boards, CET, CEE, PET, IGCSE IB AP-Physics and other exams

Consider image formation through prism. All incident rays will be deviated by

$$\delta = (\mu - 1)A = \left(\frac{3}{2} - 1\right)2^\circ = 1^\circ = \frac{\pi}{180} \text{ rad}$$

As prism is thin, object and image will be in the same plane as shown in figure.

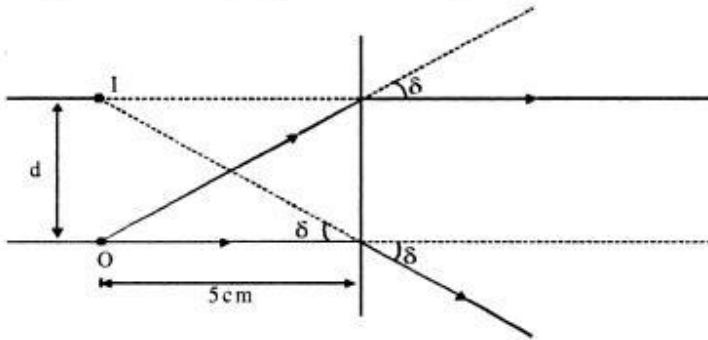

It is clear $\frac{d}{5} = \tan \delta \approx \delta$ ($\because \delta$ is very small) or $d = \frac{\pi}{36} \text{ cm}$

Now this image will act as an object for concave mirror.

$$u = -25 \text{ cm}, f = -30 \text{ cm}, \therefore v = \frac{uf}{u-f} = 150 \text{ cm}, \text{ Also, } m = \frac{-v}{u} = +6$$

$$\therefore \text{Distance of image from principal axis} = \frac{\pi}{36} \times 6 = \frac{\pi}{6} \text{ cm}$$

Hence, co-ordinates of image formed after reflection from concave mirror are

$$\left(175 \text{ cm}, \frac{\pi}{6} \text{ cm}\right)$$

A prism having an apex

angle 4° and refractive index 1.5 is located in front of a vertical plane mirror as shown in figure. Through what total angle is the ray deviated after reflection from the mirror?

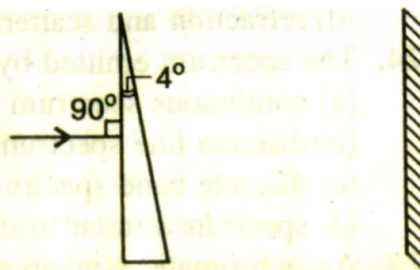

- (a) 176° (b) 4°
(c) 178° (d) 2°

$$\delta_{\text{prism}} = (\mu - 1)A = (1.5 - 1)4^\circ = 2^\circ$$

$$\begin{aligned} \therefore \delta_{\text{total}} &= \delta_{\text{prism}} + \delta_{\text{mirror}} \\ &= (\mu - 1)A + (180 - 2i) \\ &= (1.5 - 1)4^\circ + (180 - 2 \times 2^\circ) \\ &= 2^\circ + 176^\circ = 178^\circ \end{aligned}$$

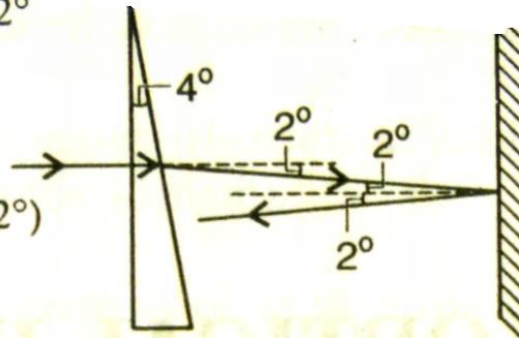

The ray diagram is shown in figure.

Optics - 5) How do we find focal length of a lens ?

Focal length of convex lens by displacement method:

- (i) When the distance between object and screen d , is greater than $4f$, then there are two positions of the lens for which the image of the object on the screen is distinct and clear. In these two positions of lens, the distances of object and image from the lens are interchanged.

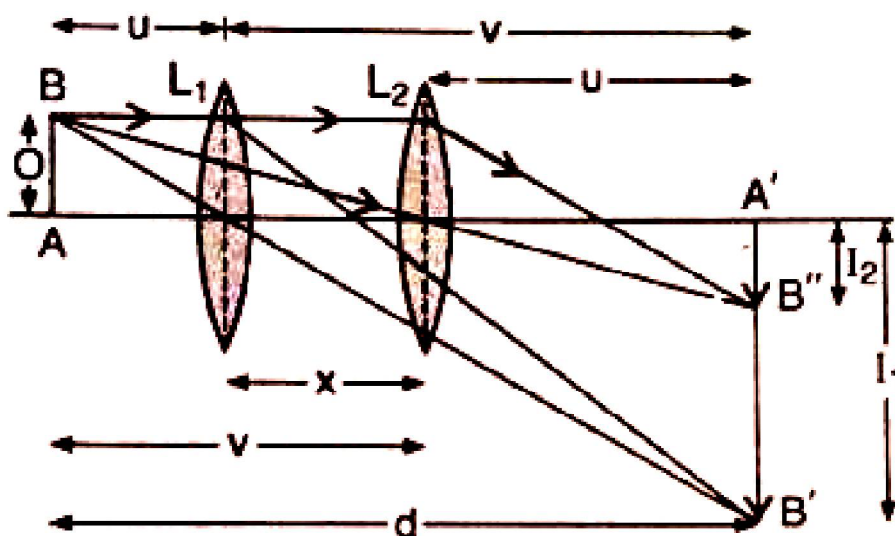

- (ii) Here, I_1 and I_2 are the lengths of images in first and second position of lens L . O is the length of the object. In first position of lens,

$$m_1 = \frac{v}{u} = \frac{I_1}{O}$$

In second position, the magnification of the lens is

given by:
$$m_2 = \frac{u}{v} = \frac{I_2}{O}$$

$$\therefore m_1 m_2 = \frac{I_1 I_2}{O^2} = 1$$

$$\therefore O = \sqrt{I_1 I_2}$$

(iii) Further,
$$\frac{m_1}{m_2} = \frac{v^2}{u^2}$$

From figure, $u + x + u = d$ or $u = \frac{d-x}{2}$

According to sign convention, $u = -(d-x)/2$

Similarly, $v = d - u = (d+x)/2$

Using lens formula, $\frac{1}{v} - \frac{1}{u} = \frac{1}{f}$, we get;

$$f = \left(\frac{d^2 - x^2}{4d} \right)$$

In the displacement method, a convex lens is placed in between an object and a screen. If the magnifications in the two positions are m_1 and m_2 and the displacement of the lens between the two positions is x , then the focal length of the lens is:

(a)
$$\frac{x}{(m_1 + m_2)}$$

(b)
$$\frac{x}{(m_1 - m_2)}$$

(c)
$$\frac{x}{(m_1 + m_2)^2}$$

(d)
$$\frac{x}{(m_1 - m_2)^2}$$

Newton 's Law of Cooling by Prof. Subhashish Chattopadhyay SKMClasses Bangalore Useful for IIT-JEE, CBSE, I.Sc. PU-II, Boards, CET, CEE, PET, IGCSE IB AP-Physics and other exams

$$m_1 = \frac{v}{u}, m_2 = \frac{u}{v}$$

$$m_1 - m_2 = \frac{v}{u} - \frac{u}{v}$$

$$m_1 - m_2 = \frac{v^2 - u^2}{uv} = \frac{(v - u)(v + u)}{uv}$$

$$\text{Now } v - u = x, \frac{1}{f} = \frac{1}{v} + \frac{1}{u} \quad \text{or} \quad \frac{1}{f} = \frac{u + v}{uv}$$

$$\therefore m_1 - m_2 = \frac{x}{f} \quad \text{or} \quad f = \frac{x}{m_1 - m_2}$$

Optics - 6) Circle of least confusion

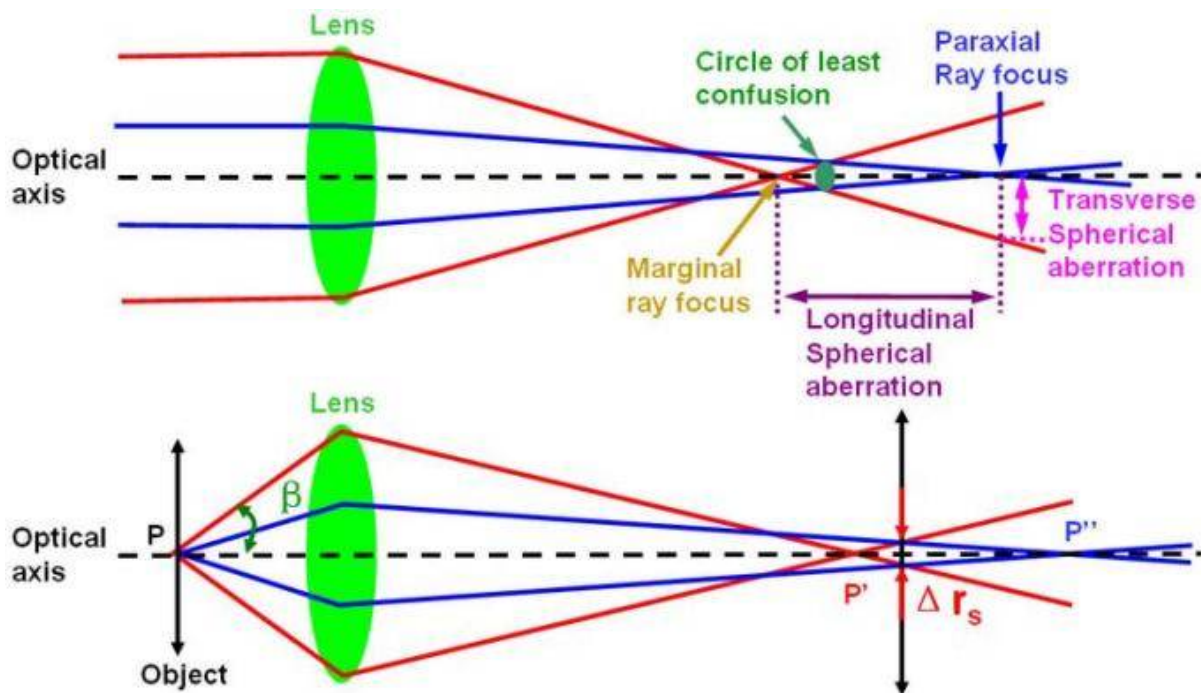

Newton 's Law of Cooling by Prof. Subhashish Chattopadhyay SKMClasses Bangalore Useful for IIT-JEE, CBSE, I.Sc. PU-II, Boards, CET, CEE, PET, IGCSE IB AP-Physics and other exams

Newton 's Law of Cooling by Prof. Subhashish Chattopadhyay SKMClasses Bangalore Useful for IIT-JEE, CBSE, I.Sc. PU-II, Boards, CET, CEE, PET, IGCSE IB AP-Physics and other exams

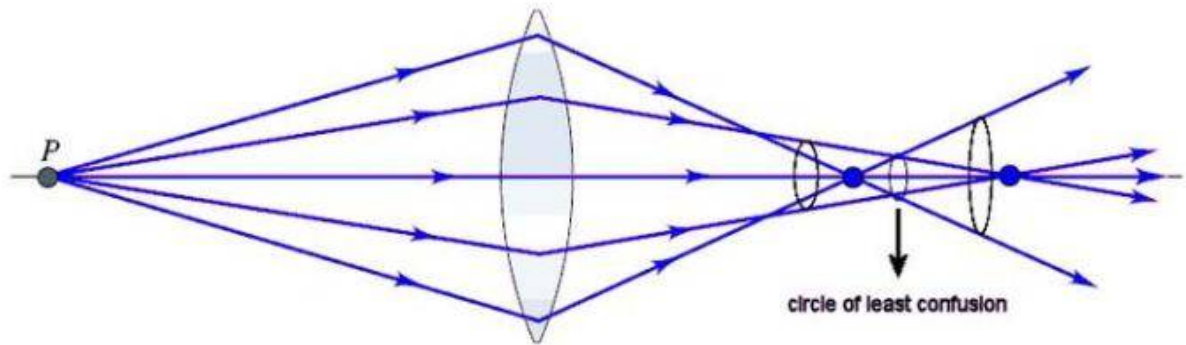

Optics - 7)



Deviation diagrams

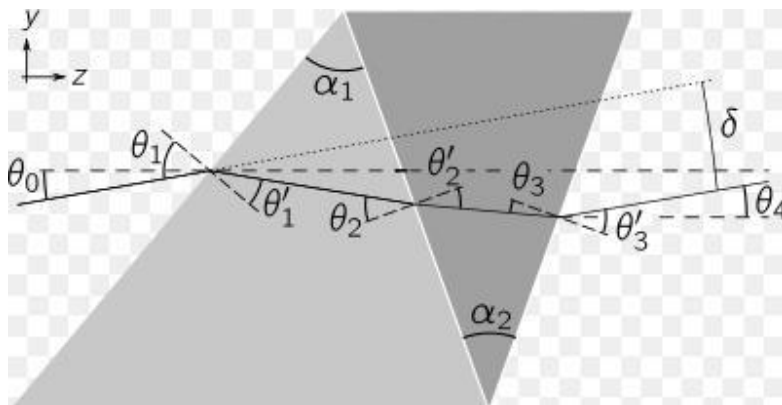

Newton 's Law of Cooling by Prof. Subhashish Chattopadhyay SKMClasses Bangalore Useful for IIT-JEE, CBSE, I.Sc. PU-II, Boards, CET, CEE, PET, IGCSE IB AP-Physics and other exams

Newton's Law of Cooling by Prof. Subhashish Chattopadhyay SKMClasses Bangalore Useful for IIT-JEE, CBSE, I.Sc. PU-II, Boards, CET, CEE, PET, IGCSE IB AP-Physics and other exams

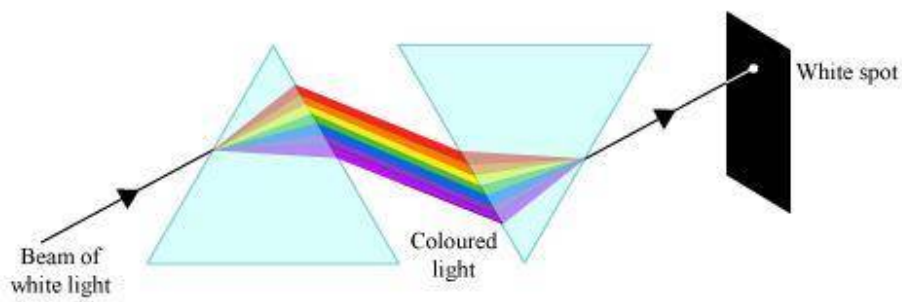
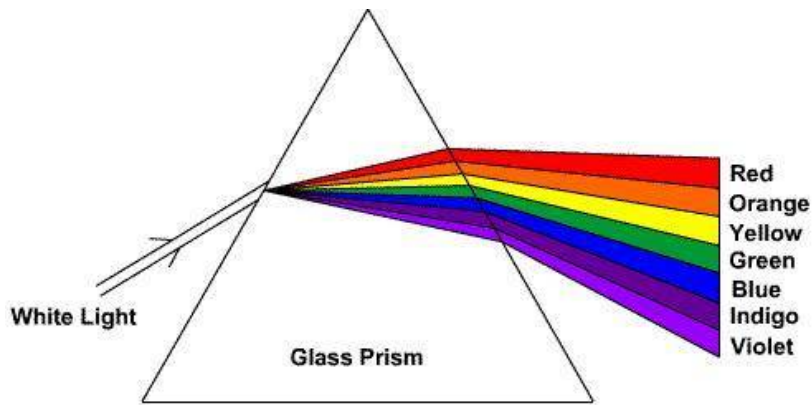

Newton's Law of Cooling by Prof. Subhashish Chattopadhyay SKMClasses Bangalore Useful for IIT-JEE, CBSE, I.Sc. PU-II, Boards, CET, CEE, PET, IGCSE IB AP-Physics and other exams

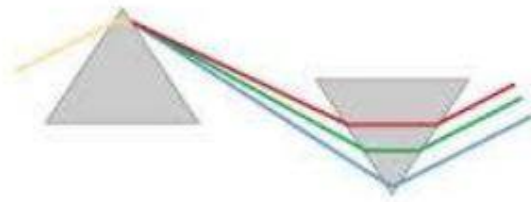

Prisms with equal vertex angle (= light deviation power) and same glass type (= equal dispersion) can exactly cancel out color that is between them.

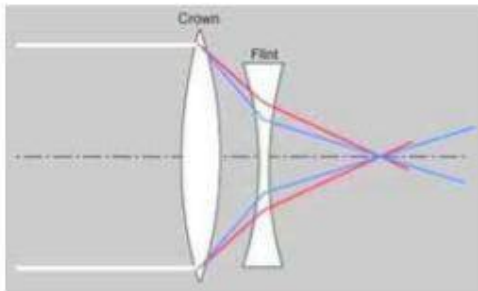

The color of a positive lens can be cancelled by an equal power negative lens of the same glass, but then the focal length of the lens pair would be zero, if they were in contact. Instead we want the negative lens to be a more dispersive glass than the positive lens, so that a weaker power negative lens can still cancel out the color and give a total power of the lens pair that is not zero. When the red and blue light rays come to the same focus primary color has been corrected.

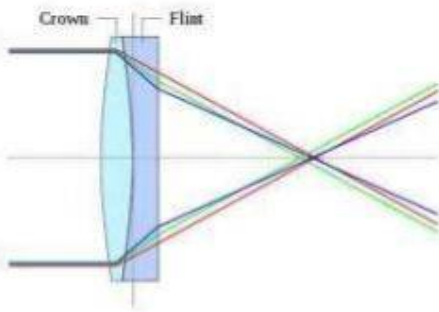

In a typical contact doublet the negative lens glass is about 1.5X to 2X more dispersive than the positive lens glass.

Newton 's Law of Cooling by Prof. Subhashish Chattopadhyay SKMClasses Bangalore Useful for IIT-JEE, CBSE, I.Sc. PU-II, Boards, CET, CEE, PET, IGCSE IB AP-Physics and other exams

Chromatic aberration

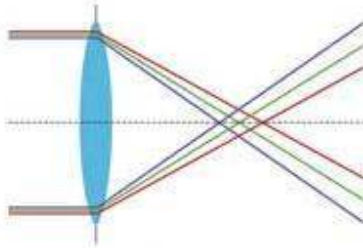

An achromatic lens

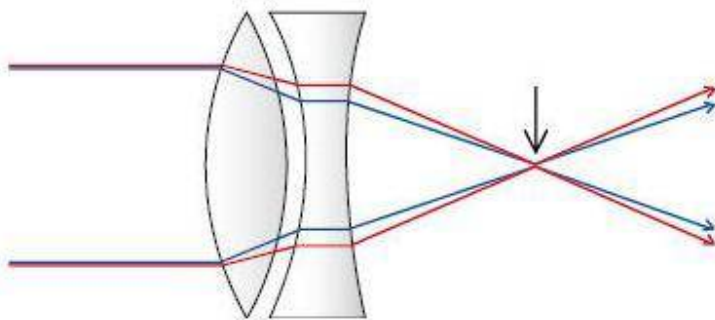
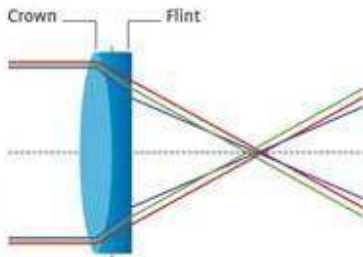

While this combination will also have a circle of least confusion

Longitudinal and Transverse Spherical Aberration

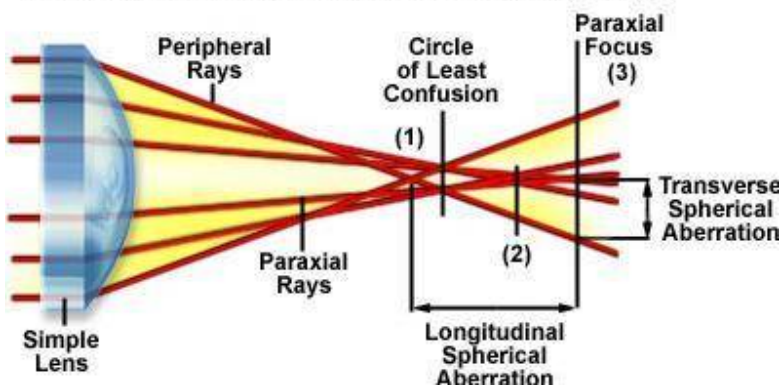

Newton 's Law of Cooling by Prof. Subhashish Chattopadhyay SKMClasses Bangalore Useful for IIT-JEE, CBSE, I.Sc. PU-II, Boards, CET, CEE, PET, IGCSE IB AP-Physics and other exams

Optics - 8) Aspherical lenses can be used to reduce axial spread (of paraxial rays), apart from stoppers or rather with combinations of stoppers.

Aspherical Lens

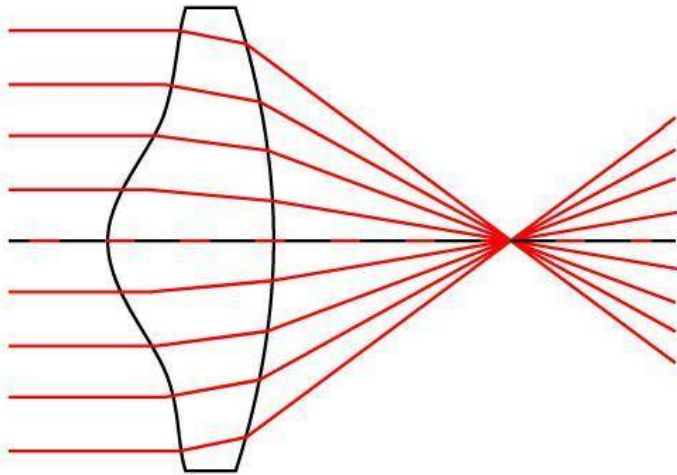

Remember more curved surface should face the light first. In plano-convex lens the convex part should face the light for better utilization of refraction properties. Also this minimizes the errors.

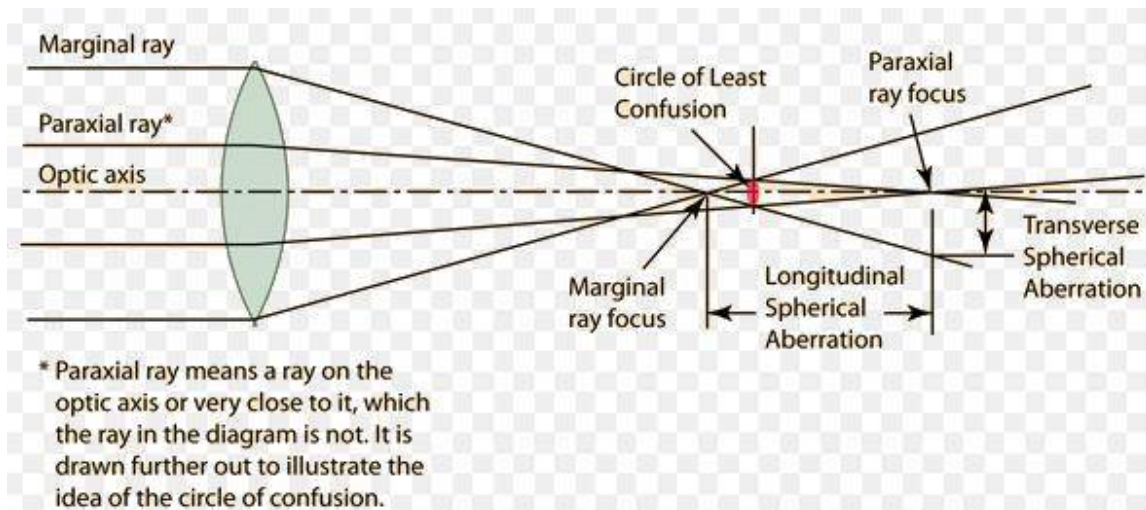

Optics - 9) The conical image of a point

Looking at only red and blue light:

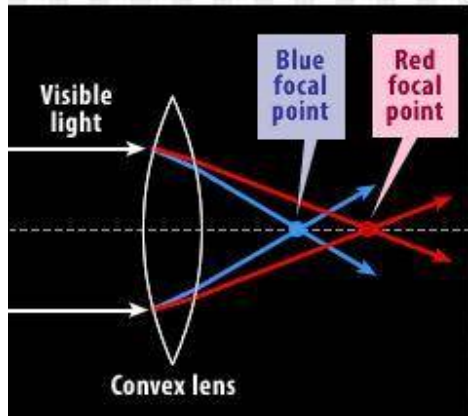

Result: A fringe of color may appear around bright objects seen through the lens:



A star, as seen through a telescope without chromatic aberration



A star, as seen through a telescope with chromatic aberration (exaggerated)

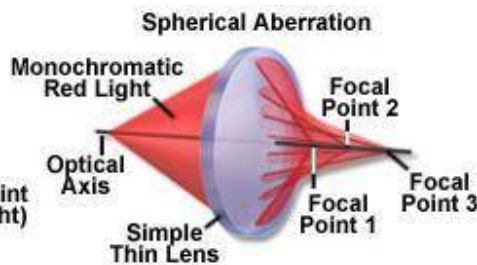
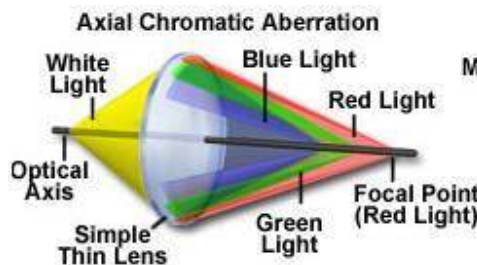

Optics - 10) Split lenses

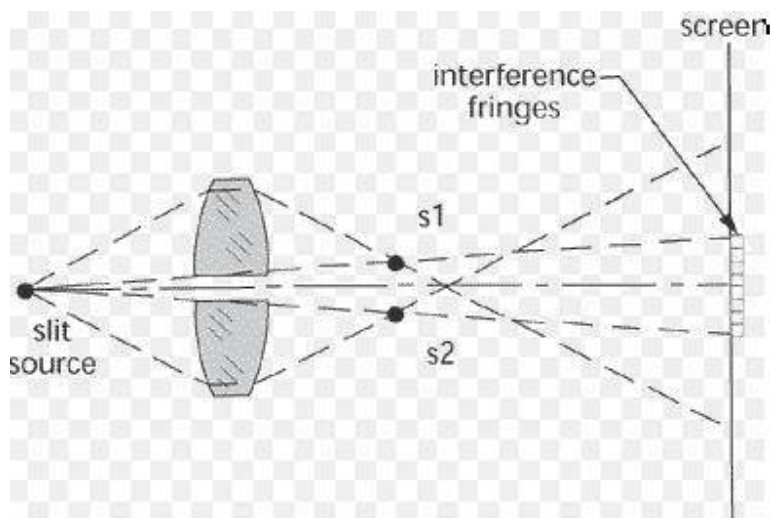

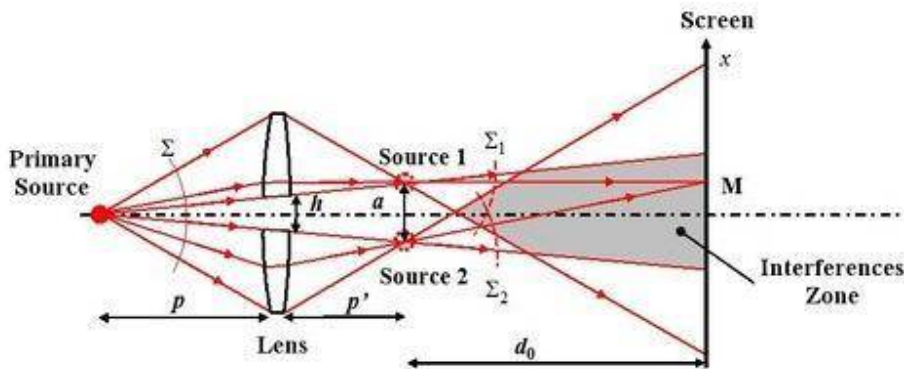

- Was asked in Physics Olympiad before being asked in IIT JEE

A thin plano-convex lens of focal length f is split into two halves. One of the halves is shifted along the optical axis. The

separation between object and image planes is 1.8 m. The magnification of the image formed by one of the half lens is 2. Find the focal length of the lens and separation between the halves. Draw the ray diagram for image formation. (1996, 5M)

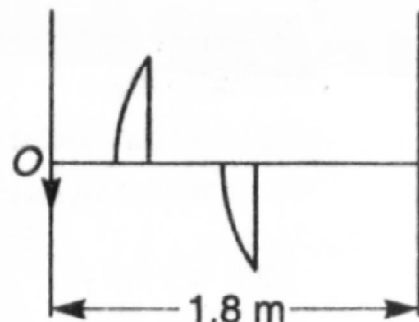

Solution

For both the halves, position of object and image is same. Only difference is of magnification. Magnification for one of the halves is given as $2 (> 1)$. This can be for the first one, because for this, $|v| > |u|$. Therefore, magnification, $|m| = |v/u| > 1$

So, for the first half

$$|v/u| = 2 \quad \text{or} \quad |v| = 2|u|$$

Let $u = -x$ then $v = +2x$ and $|u| + |v| = 1.8\text{m}$

$$\text{i.e., } 3x = 1.8 \text{ m} \quad \text{or} \quad x = 0.6 \text{ m}$$

Hence, $u = -0.6 \text{ m}$ and $v = +1.2 \text{ m}$.

$$\text{Using, } \frac{1}{f} = \frac{1}{v} - \frac{1}{u} = \frac{1}{1.2} - \frac{1}{-0.6} = \frac{1}{0.4}$$

$$\therefore f = 0.4 \text{ m}$$

For the second half

$$\frac{1}{f} = \frac{1}{1.2 - d} - \frac{1}{-(0.6 + d)}$$

$$\text{or } \frac{1}{0.4} = \frac{1}{1.2 - d} + \frac{1}{0.6 + d}$$

Solving this, we get $d = 0.6 \text{ m}$.

Magnification for the second half will be

$$m_2 = \frac{v}{u} = \frac{0.6}{-(1.2)} = -\frac{1}{2}$$

and magnification for the first half is

$$m_1 = \frac{v}{u} = \frac{1.2}{-(0.6)} = -2$$

The ray diagram is as follows :

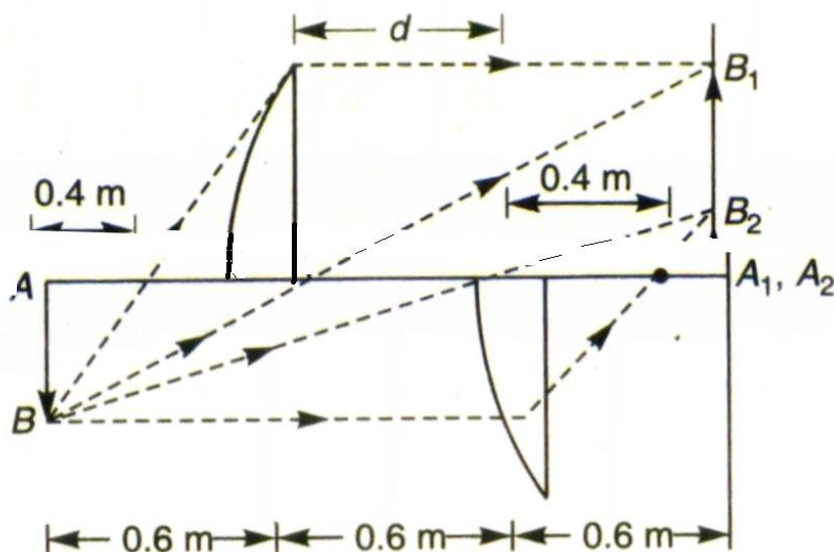

In given figure, S is a monochromatic point source emitting light of wavelength $\lambda = 500\text{ nm}$. A thin lens of circular shape and focal length 0.10 m is cut into two identical halves L_1 and L_2 by a plane passing through a diameter. The two halves are placed symmetrically about the central axis SO with a gap of 0.5 mm . The distance along the axis from S to L_1 and L_2 is 0.15 m while that from L_1 and L_2 to O is 1.30 m . The screen at O is normal to SO . **(1993, 5+1M)**

Solution

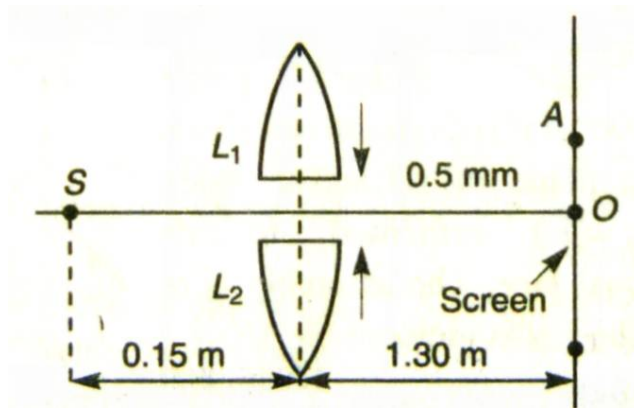

If the third intensity maximum occurs at the point A on the screen, find the distance OA .

If the gap between L_1 and L_2 is reduced from its original value of 0.5 mm , will the distance OA increase, decrease, or remain the same.

(a) For the lens, $u = -0.15 \text{ m}$; $f = +0.10 \text{ m}$

Therefore, using $\frac{1}{v} - \frac{1}{u} = \frac{1}{f}$ we have

$$\frac{1}{v} = \frac{1}{u} + \frac{1}{f}$$

$$= \frac{1}{(-0.15)} + \frac{1}{(0.10)}$$

or $v = 0.3 \text{ m}$

Linear magnification, $m = \frac{v}{u} = \frac{0.3}{-0.15} = -2$

Hence, two images S_1 and S_2 of S will be formed at 0.3 m from the lens as shown in figure. Image S_1 due to part 1

will be formed at 0.5 mm above its optic axis ($m = -2$). Similarly, S_2 due to part 2 is formed 0.5 mm below the optic axis of this part as shown.

Hence, $d =$ distance between S_1 and $S_2 = 1.5 \text{ mm}$

$$D = 1.30 - 0.30 = 1.0 \text{ m} = 10^3 \text{ mm}$$

$$\lambda = 500 \text{ nm} = 5 \times 10^{-4} \text{ mm}$$

Therefore, fringe width,

$$\omega = \frac{\lambda D}{d} = \frac{(5 \times 10^{-4})(10^3)}{(1.5)} = \frac{1}{3} \text{ mm}$$

Now, as the point A is at the third maxima

$$OA = 3\omega = 3(1/3) \text{ mm}$$

or $OA = 1 \text{ mm}$

- (b) If the gap between L_1 and L_2 is reduced, d will decrease. Hence, the fringe width ω will increase or the distance OA will increase.

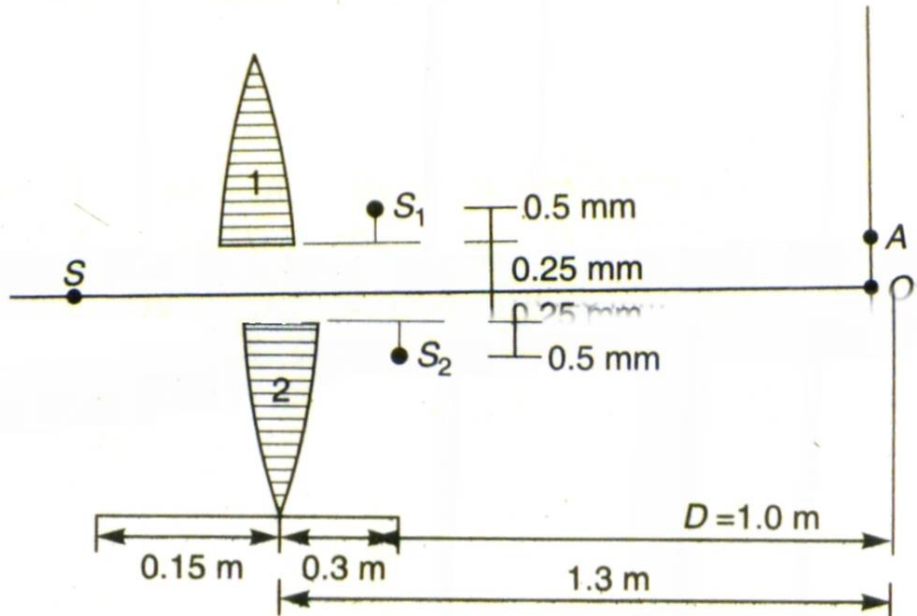

Optics - 11) Lloyd's Mirror

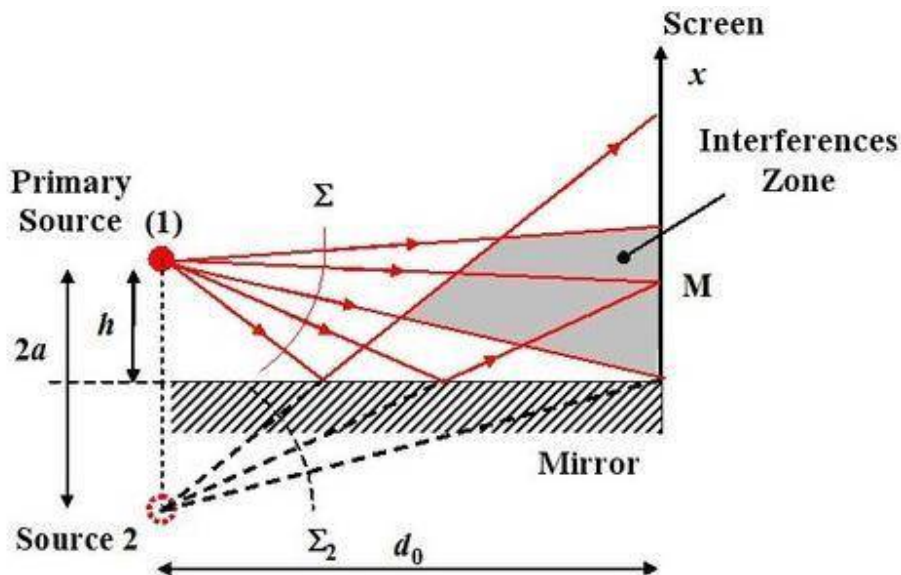

Newton's Law of Cooling by Prof. Subhashish Chattopadhyay SKMClasses Bangalore Useful for IIT-JEE, CBSE, I.Sc. PU-II, Boards, CET, CEE, PET, IGCSE IB AP-Physics and other exams

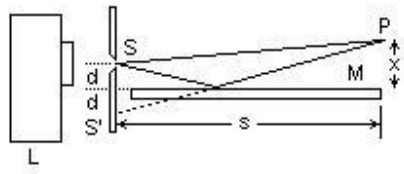

Lloyd's Mirror

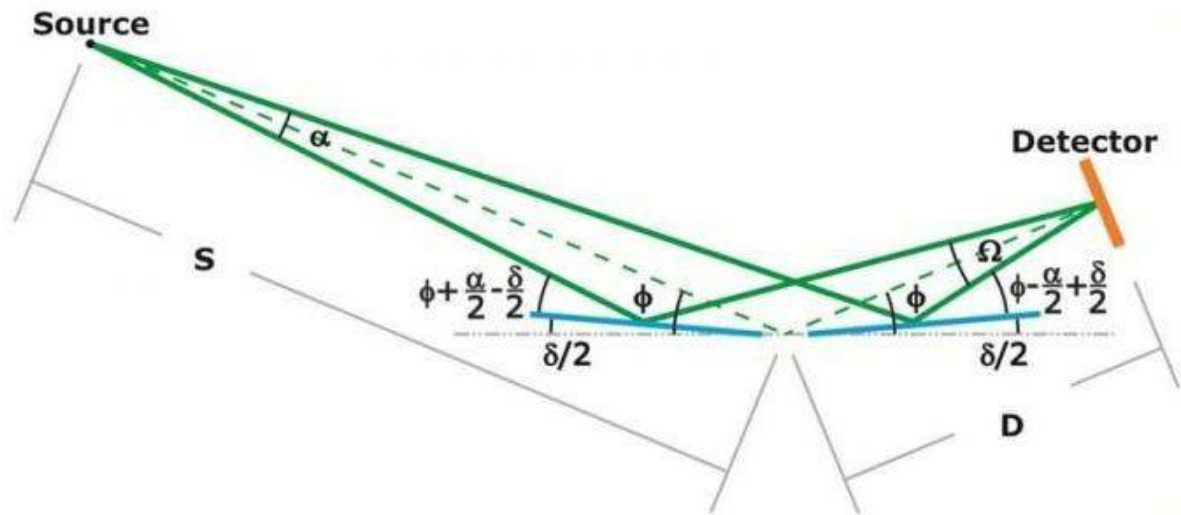

Optics - 12) Newton's Rings

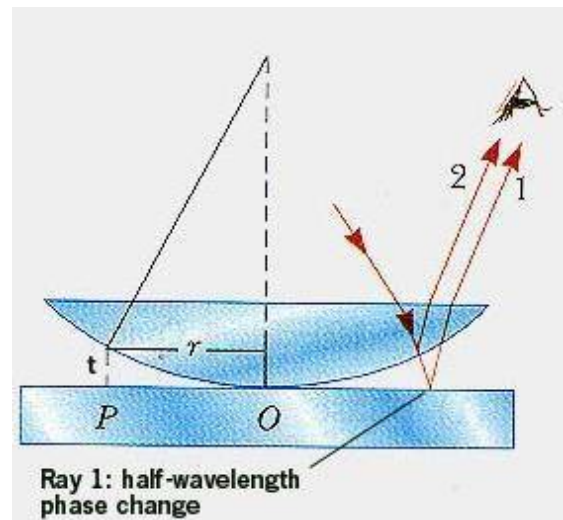
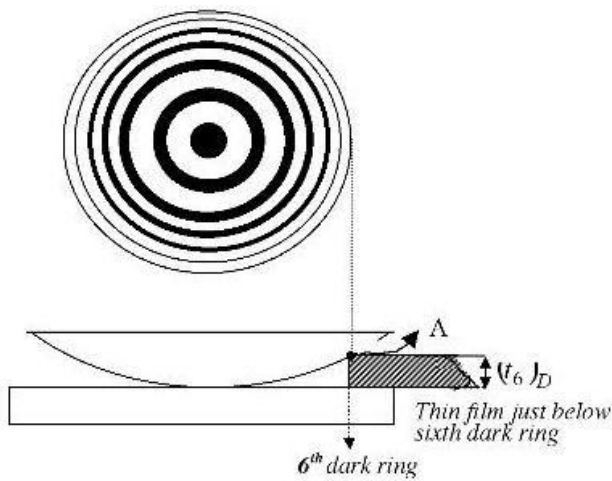

Newton's Law of Cooling by Prof. Subhashish Chattopadhyay SKMClasses Bangalore Useful for IIT-JEE, CBSE, I.Sc. PU-II, Boards, CET, CEE, PET, IGCSE IB AP-Physics and other exams

film thickness t .

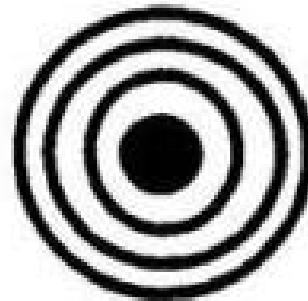
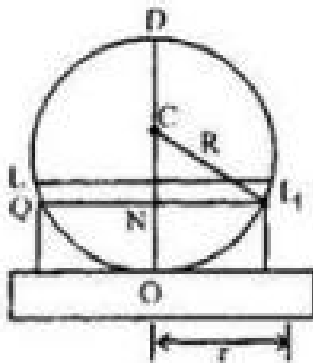

Fig. Newton Rings in Reflected Light

$$2t + \frac{\lambda}{2} = n\lambda$$

$$2t = \frac{(2n-1)\lambda}{2} \text{ for a bright ring } n = 1, 2, 3, \dots$$

&

$$2t = n\lambda \text{ for dark ring } n = 0, 1, 2, 3, \dots$$

From the property of the circle,

$$NP \times NQ = NO \times ND$$

Substituting values,

$$r \times r = t \times (2R - t) = 2Rt - t^2 \approx 2Rt \text{ approximately.}$$

\therefore

$$t = \frac{r^2}{2R}$$

Thus, for bright ring,

$$2 \cdot \frac{r^2}{2R} = \frac{(2n-1)\lambda}{2}$$

$$r = \frac{D}{2} \text{ where } D \text{ is diameter}$$

$$\frac{D^2}{4} = \frac{(2n-1)\lambda R}{2}$$

$$D_n = \sqrt{2(2n-1)\lambda R}$$

$$D_n \propto \sqrt{(2n-1)}$$

i.e., diameter of n^{th} bright ring is proportional to square root of odd natural number.

Optics - 13) Plano-Convex lens problems

The apparent thickness of a thick plano-convex lens is measured once with the plane face upward and then with the convex face upwards. The value will be :

- (a) More in the first case.
- (b) Same in the two cases
- (c) More in the II case
- (d) Can be any of the above depending on the value of its actual thickness

The apparent thickness in case (a)

$$OA' = \frac{\text{real } (OA)}{\mu} = \frac{t}{\mu}$$

In case (b) when the convex surface is placed down then refraction takes place through curved surface.

Object is in denser medium, then $\mu_2 = 1, \mu_1 = \mu$

$$\therefore \text{ by } \frac{\mu_2}{v} - \frac{\mu_1}{u} = \frac{\mu_2 - \mu_1}{R}$$

$$\frac{1}{v} + \frac{\mu}{t} = \frac{1 - \mu}{-R}$$

$$\frac{1}{v} = \frac{(\mu - 1)}{R} - \frac{\mu}{t}$$

$$v = \frac{Rt}{(\mu - 1)t - \mu R}$$

Clearly in the second case the apparent thickness is more.

Optics - 14) Lens problems with graphs

The graph shows how the magnification m produced by a thin convex lens varies with image distance v . What was the focal length of the lens used ?

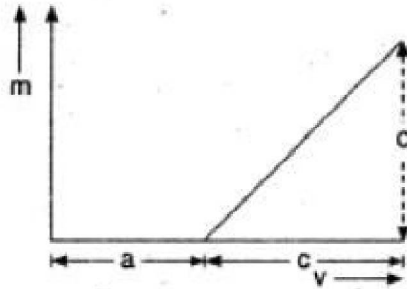

- (a) b/c (b) b/ca (c) bc/a (d) c/b

For point B, $m = b$ or $\frac{v}{u} = b$

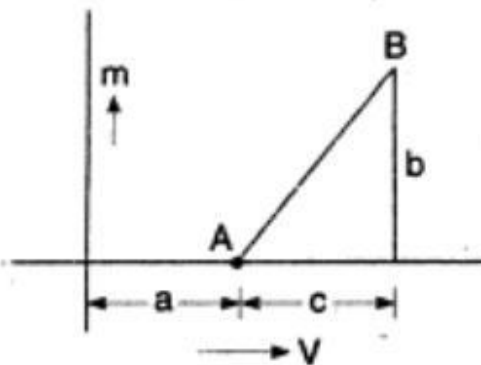

$$\frac{(a+c)}{u} = b \text{ or } u = \left(\frac{a+c}{b}\right)$$

$$\frac{1}{f} = \frac{1}{(a+c)} + \frac{b}{(a+c)} = \frac{(1+b)}{(a+c)} \text{ or } f = \left(\frac{a+c}{1+b}\right) \dots(1)$$

Again for point A, $m = 0$

Newton's Law of Cooling by Prof. Subhashish Chattopadhyay SKMClasses Bangalore Useful for IIT-JEE, CBSE, I.Sc. PU-II, Boards, CET, CEE, PET, IGCSE IB AP-Physics and other exams

$$v = a, m = 0 = \frac{v}{u} = \frac{a}{u}$$

$$u = \infty \therefore v = a = f$$

Putting in (1)

$$f = \frac{f+c}{1+b}, f+fb = f+c \text{ or } f = \frac{c}{b}$$

IIT JEE 2011

A light ray traveling in glass medium is incident on glass-air interface at an angle of incidence θ . The reflected (R) and transmitted (T) intensities, both as function of θ , are plotted. The correct sketch is

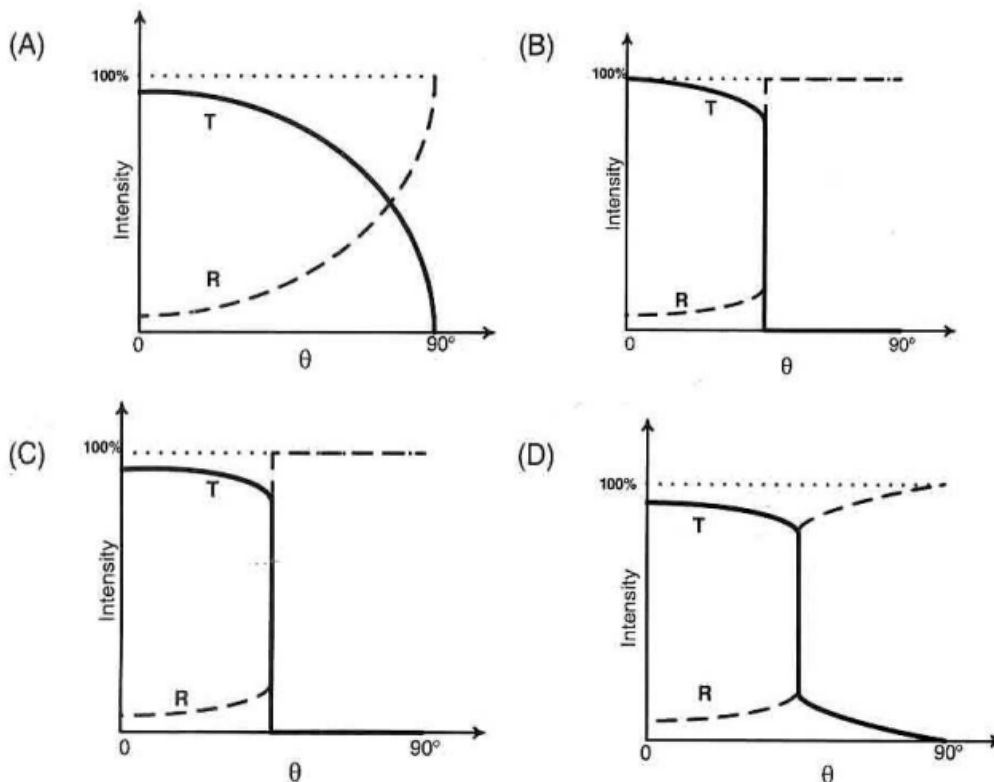

Answer [c]

Newton's Law of Cooling by Prof. Subhashish Chattopadhyay SKMClasses Bangalore Useful for IIT-JEE, CBSE, I.Sc. PU-II, Boards, CET, CEE, PET, IGCSE IB AP-Physics and other exams

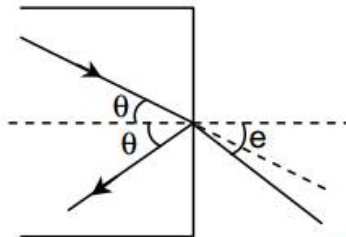

When $\theta > \theta_c$, no ray will transmit
 $\Rightarrow T = 0, T + R = 100\%$ and $R > 0$

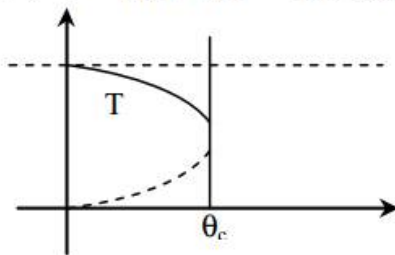

A ray of light travels from a medium of refractive index μ to air. Its angle of incidence in the medium is θ , measured from the normal to the boundary and its angle of deviation is δ . δ is plotted against θ which of the following best represents the resulting curve?

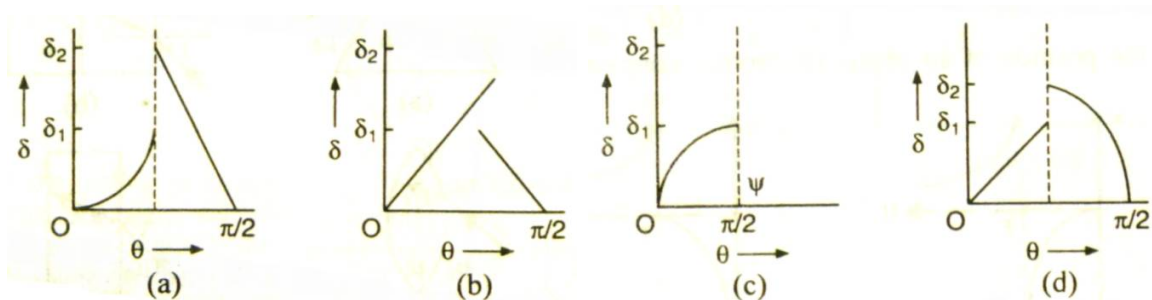

Answer (a)

In the above problem which of the following relations are correct

(a) $\psi = \sin^{-1} \left(\frac{1}{\mu} \right)$

(b) $\psi = \frac{\pi}{2} - \sin^{-1} \left(\frac{1}{\mu} \right)$

(c) $\frac{\delta_2}{\delta_1} = \mu$

(d) $\frac{\delta_2}{\delta_1} = 2$

Answer (a) and (d)

For which of the following cases $(\sin i/\sin r)$ is equal to (μ/μ_0) ?

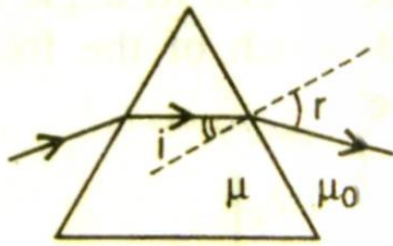

(a)

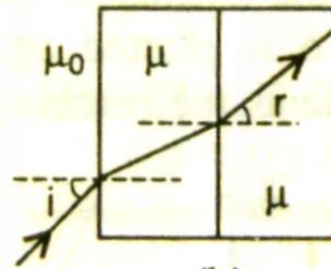

(b)

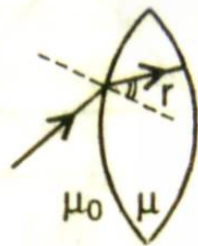

(c)



(d)

Answer - b, c, d

As the position of an object (u) from a concave mirror is varied, the position of the image (v) also varies. By letting u change from 0 to ∞ the graph between v and u will be ?

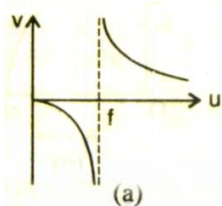

(a)

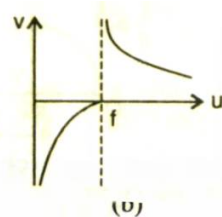

(b)

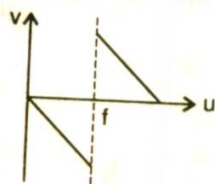

(c)

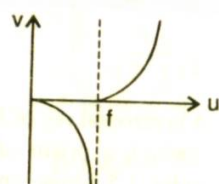

(d)

Answer - (a)

A reflecting surface is represented by the equation $x^2 + y^2 = a^2$. A ray travelling in negative x -direction is directed towards positive y -direction after reflection from the surface at some point P . Then the co-ordinates of point P are:

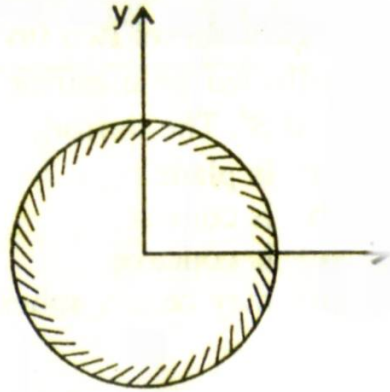

- (a) $(0.8a, 0.6a)$
- (b) $(0.6a, 0.8a)$
- (c) $(a, 0)$
- (d) none of the above

The ray diagram is shown in the figure.

$$x = \frac{a}{\sqrt{2}} \quad \text{and} \quad y = \frac{a}{\sqrt{2}}$$

$$\therefore P = \left(\frac{a}{\sqrt{2}}, \frac{a}{\sqrt{2}} \right)$$

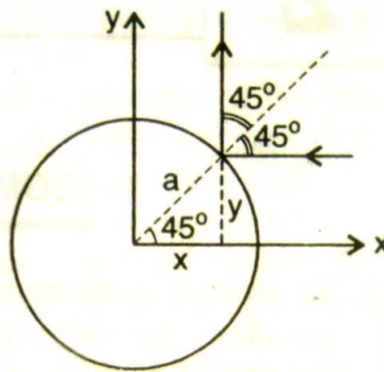

So Answer - (d)

Optics - 15) Lens immersed in a liquid

The focal length of lens of refractive index 1.5 in air is 30 cm. When it is immersed in a liquid of refractive index $\frac{4}{3}$, then its focal length in liquid will be

- (a) 30 cm
 - (b) 60 cm
 - (c) 120 cm
 - (d) 240 cm
- (BHU 2002)

We know that focal length in liquid

$$(f_m) = \left[\frac{\mu_g - 1}{(\mu_g / \mu_m) - 1} \right] \times f_a = \left[\frac{1.5 - 1}{(1.5 / 1.33) - 1} \right] \times 30$$

$$= \left[\frac{1.5 - 1}{1.125 - 1} \right] \times 30 = 120 \text{ cm.}$$

A bi-convex lens ($\mu = 1.5$) of focal length 0.2 m acts as a divergent lens of power one dioptre when immersed in a liquid. The refractive index of the liquid is :

- (a) 1.33 (b) 1.67 (c) 1.25 (d) 1.2

$$f_a = 20 \text{ cm, } f_w = -100 \text{ cm.}$$

$$\therefore \frac{f_w}{f_a} = \frac{(a\mu_g - 1)}{\left(\frac{a\mu_g}{a\mu_w} - 1 \right)} \quad \text{or} \quad -\frac{100}{20} = \frac{(1.5 - 1)}{\left(\frac{1.5}{a\mu_w} - 1 \right)}$$

$$\text{or } \frac{1.5}{a\mu_w} - 1 = -\frac{0.5}{5} = -\frac{1}{10}$$

$$\therefore \frac{1.5}{a\mu_w} = 1 - \frac{1}{10} = \frac{9}{10}$$

$$a\mu_w = \frac{15}{9} = 1.67$$

Karnataka CET 1996 problem - Lens put in Slab with liquid

Shown in the figure is a convergent lens placed inside a cell filled with a liquid. The lens has a focal length +20 cm. when in air and its material has a refractive index 1.50. If the liquid has a refractive index 1.60, the focal length of the system is: (II-U-1-3)

- 1) -24 cm 2) -100 cm
3) +80 cm 4) -80 cm

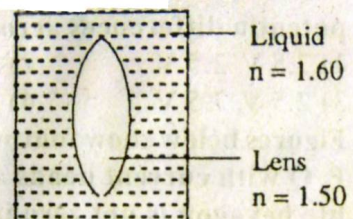

$$\begin{aligned} \text{In air } \frac{1}{f} &= (n_g - 1) \left(\frac{1}{R_1} + \frac{1}{R_2} \right) \\ \frac{1}{20} &= 0.5 \left(\frac{1}{R_1} + \frac{1}{R_2} \right) \rightarrow \left(\frac{1}{R_1} + \frac{1}{R_2} \right) = \frac{1}{20 \times 0.5} = \frac{1}{10} \\ \text{In the liquid} \\ \frac{1}{f^l} &= \left(\frac{n_g}{n_e} - 1 \right) \left(\frac{1}{R_1} + \frac{1}{R_2} \right) = \left(\frac{1.5}{1.6} - 1 \right) \times \frac{1}{10} \\ &= -\frac{1}{16} \times \frac{1}{10} = -\frac{1}{160} \quad \text{or} \quad f = -160 \text{ cm} \end{aligned}$$

If the formula was printed as +ve, then the absolute values of Radius will be taken.

Given ${}^a\mu_g = 3/2$ and ${}^a\mu_w = 4/3$. There is an equiconvex lens with radius of each surface equal to 20 cm. There is air in the object space and water in the image space. The focal length of lens is:

- (a) 80 cm (b) 40 cm (c) 20 cm (d) 10 cm

Solution :

$$\begin{aligned} \frac{{}^a\mu_w}{f} &= \frac{({}^a\mu_g - 1)}{R_1} - \frac{({}^a\mu_g - {}^a\mu_w)}{R_2} \\ &= \frac{\left(\frac{3}{2} - 1 \right)}{20} - \frac{\left(\frac{3}{2} - \frac{4}{3} \right)}{-20} = \frac{1}{40} + \frac{1}{120} = \frac{1}{30} \\ f &= \frac{4}{3} \times 30 = 40 \text{ cm} \end{aligned}$$

There can be problems with lens and different transparent materials on either side or both sides

A hollow double concave lens is made of very thin transparent material. It can be filled with air or either of two liquids L_1 or L_2 having refractive indices n_1 and n_2 respectively ($n_2 > n_1 > 1$). The lens will diverge a parallel beam of light if it is filled with: **(IIT 2000)**

- (a) air and placed in air (b) air and immersed in L_1
(c) L_1 and immersed in L_2 (d) L_2 and immersed in L_1

Solution : (d)

The lens maker's formula is:

$$\frac{1}{f} = \left(\frac{n_L}{n_m} - 1 \right) \left(\frac{1}{R_1} - \frac{1}{R_2} \right)$$

Where n_L = refractive index of lens material

n_m = refractive index of medium

In case of double concave lens R_1 is -ve and R_2 is +ve. Therefore

$\left(\frac{1}{R_1} - \frac{1}{R_2} \right)$ will be -ve.

For the lens to be diverging in nature, focal length f should be

negative or $\left(\frac{n_L}{n_m} - 1 \right)$ should be positive or $n_L > n_m$; but since

$n_2 > n_1$ (given), therefore the lens should be filled with L_2 and immersed in L_1 .

Optics - 16) Trick questions with distance of object, Image, focal length of lenses

The focal length of a convex lens is f . An object is placed at a distance x from its first focal point. The ratio of the size of the real image to that of the object is :

- (a) f/x^2 (b) x^2/f (c) f/x (d) x/f

$$u = f + x, \frac{1}{f} = \frac{1}{v} - \frac{1}{-u} = \frac{1}{v} + \frac{1}{u}$$

$$\frac{1}{f} = \frac{1}{v} + \frac{1}{f+x} \quad \text{or} \quad \frac{1}{v} = \frac{1}{f} - \frac{1}{f+x}$$

$$\frac{1}{v} = \frac{f+x-f}{f(f+x)} = \frac{x}{f(f+x)} \quad \text{or} \quad v = \frac{f(f+x)}{x}$$

$$\frac{v}{u} = \frac{f(f+x)}{x(f+x)} = \frac{f}{x}$$

An object is placed at a point distant x from the focus of a convex lens and its image is formed at I as shown in the figure. The distances x, x' satisfy the relation :

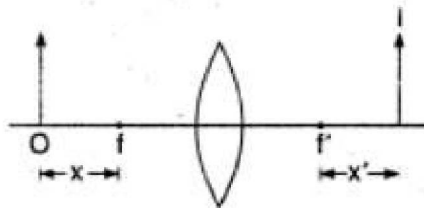

- (a) $\frac{x \times x'}{2} = f$ (b) $f^2 = xx'$
 (c) $x + x' = 2f$ (d) $x - x' = 2f$

the magnification is :

- (a) $\frac{f}{x+x'}$ (b) $\frac{x'}{x}$
 (c) $\frac{f}{x}$ (d) None of these

$$xx' = f^2, \text{ Newton's formula.}$$

$$u = f + x, v = f + x'$$

$$m = \frac{v}{u} = \frac{f + x'}{f + x}$$

$$x' = \frac{f^2}{x} \therefore m = \frac{f + f^2/x}{f + x}$$

$$m = \frac{f(x + f)}{x(x + f)} = \frac{f}{x}$$

A convex lens of focal length f is placed somewhere in between an object and a screen. The distance between the object and the screen is x . If the numerical value of the magnification produced by the lens is m , the focal length of the lens is:

(a) $\frac{mx}{(m+1)^2}$ (b) $\frac{mx}{(m-1)^2}$ (c) $\frac{(m+1)^2}{m}x$ (d) $\frac{(m-1)^2}{m}x$

Here,

$$x = u + v$$

$$m = \frac{f}{f+u} = \frac{f-v}{f}$$

For real image, m is -ve.

$$\therefore -m = f/(f+u) \quad \text{or} \quad u = \frac{-(m+1)}{m}f$$

$$\text{and} \quad -m = \frac{f-v}{f} \quad \text{or} \quad v = (m+1)f$$

$$\therefore x = (m+1)f + \frac{(m+1)}{m}f \quad \text{or} \quad f = \frac{mx}{(m+1)^2}$$

The distance between object and the screen is D . Real images of an object are formed on the screen for two positions of a lens separated by a distance d . The ratio between the sizes of two images will be:

- (a) D/d (b) D^2/d^2
 (c) $(D-d)^2/(D+d)^2$ (d) $\sqrt{D/d}$

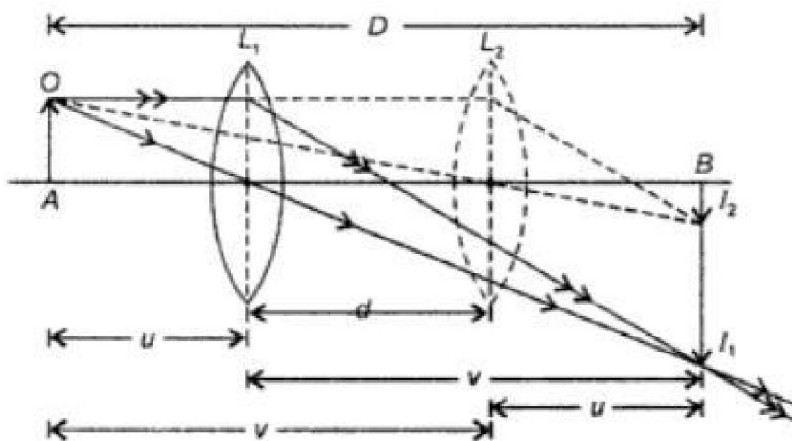

Let O be the size of object held perpendicular to the principal axis of the lens. A real, inverted and magnified image of size I_1 is formed when the lens is at position L_1 . When the lens is shifted to position L_2 after moving to a distance d , a diminished image of size I_2 is formed.

The magnification produced by lens, when image size is I_1 .

$$m_1 = \frac{I_1}{O} = \frac{v}{u} \quad \dots(i)$$

The magnification produced by lens, when image size is I_2 .

$$m_2 = \frac{I_2}{O} = \frac{u}{v} \quad \dots(ii)$$

(By the principle of conjugate focii we can assume position of image as object position and vice-versa)

From equation (i) and (ii), we get

$$m_1 m_2 = \frac{I_1}{O} \times \frac{I_2}{O} = \frac{v}{u} \times \frac{u}{v}$$

or $m_1 m_2 = 1$

and $O = \sqrt{I_1 I_2}$

Again, from equation (i) and (ii)

$$\frac{m_1}{m_2} = \frac{I_1}{I_2} = \frac{v^2}{u^2}$$

From the figure, $D = u + v$

and $d = v - u$

Then $v = \frac{D + d}{2}$ and $u = \frac{D - d}{2}$

Hence, $\frac{m_1}{m_2} = \frac{I_1}{I_2} = \left(\frac{D + d}{D - d} \right)^2$

Using lens formula $\frac{1}{f} = \frac{1}{v} - \frac{1}{u}$ and putting the value of

$$u = -\left(\frac{D - d}{2} \right) \text{ and } v = +\left(\frac{D + d}{2} \right), \text{ we get}$$

$$f = \frac{D^2 - d^2}{4D}$$

The focal length of lens can also be calculated by relation

$$f = \frac{d}{m_1 - m_2}$$

Thus

- (i) The minimum distance between the object and its real image is $4f$.
- (ii) If the distance between object and screen is greater than $4f$. There will be two positions separated by d for the lens which gives sharp image on the screen.
- (iii) As the lens is moved away from the source, the diminished image is formed.

(iv) Power of lens can also be calculated by the relation

$$P = \frac{4D}{D^2 - d^2}$$

A convex lens produces an image of real object

on a screen with magnification $\frac{1}{2}$ when the

lens is moved 30 cm towards the object, the magnification of the image on the screen is 2.

Find the focal length of the lens.

Solution : Since, $f = \frac{d}{m_1 - m_2}$

Here $d = 30$ cm, $m_1 = 2$ and $m_2 = \frac{1}{2}$

So, $f = \frac{30}{2 - \frac{1}{2}} = 20$ cm.

A short linear object of length L lies on the axis of a spherical mirror of focal length f at a distance u from the mirror. Its image has an axial length L' equal to ?

(a) $L \left[\frac{f}{(u-f)} \right]^{1/2}$

(b) $L \left[\frac{(u+f)}{f} \right]^{1/2}$

(c) $L \left[\frac{(u-f)}{f} \right]^2$

(d) $L \left[\frac{f}{(u-f)} \right]^2$

Solution :

$$\frac{1}{v} + \frac{1}{u} = \frac{1}{f} \quad \text{or} \quad -\frac{dv}{v^2} - \frac{du}{u^2} = 0$$

i.e., $dv = -du[v/u]^2$

But $v = \frac{uf}{(u-f)}$ or $\frac{v}{u} = \frac{f}{(u-f)}$

So $dv = -du \left[\frac{f}{(u-f)} \right]^2$

Hence, $|dv| = L \left[\frac{f}{(u-f)} \right]^2$

A concave mirror of focal length f produces an image n times the size of the object. If the image is real, then the distance of the object from the mirror is:

- (a) $(n - 1)f$ (b) $[(n - 1)/n]f$
(c) $[(n + 1)f/n]$ (d) $(n + 1)f$

As the image is real it will be inverted and so

$$m = -(v/u) = -n, \quad \text{i.e.,} \quad v = nu$$

$$\therefore \quad \frac{1}{v} + \frac{1}{u} = \frac{1}{f} \quad \text{or} \quad \frac{1}{nu} + \frac{1}{u} = \frac{1}{-f}$$

$$\text{or} \quad \frac{(1+n)}{nu} = -\frac{1}{f} \quad \text{or} \quad u = -\frac{(n+1)}{n}f$$

i.e., object is in front of mirror at a distance $[(n + 1)f/n]$.

A convex mirror of focal length f produces an image $(1/n)$ th of the size of the object. The distance of the object from the mirror is:

- (a) nf (b) f/n (c) $(n + 1)f$ (d) $(n - 1)f$

Solution :

As the image formed by a convex mirror is always virtual or erect, so

$$m = -(v/u) = + (1/n) \quad \text{or} \quad v = -\frac{u}{n}$$

$$\therefore \quad \frac{1}{v} + \frac{1}{u} = \frac{1}{f} \quad \text{or} \quad -\frac{n}{u} + \frac{1}{u} = \frac{1}{+f}$$

$$\text{or} \quad \frac{-(n-1)}{u} = \frac{1}{f} \quad \text{or} \quad u = -(n-1)f$$

i.e., object is in front of mirror at a distance $(n - 1)f$.

Optics - 17) Application of Geometry in sphere to understand a plano-convex lens problem

Diameter of a plano-convex lens is 6 cm and thickness at the centre is 3 mm. If the speed of light in the material of the lens is 2×10^8 metres per sec, the focal length of the lens is :

- (a) 15 cm (b) 20 cm (c) 30 cm (d) 10 cm

Application of Sagitta Theorem

$$\text{R.I. of material of lens } \mu = \frac{c}{v} = \frac{3 \times 10^8}{2 \times 10^8} = 1.5$$

by Sagitta theorem

$$0.3 (2R - 0.3) = 3 \times 3$$

$$0.6R = 9 \quad (\text{neglecting } 0.09)$$

$$R = 15 \text{ cm}$$

$$\frac{1}{f} = (\mu - 1) \left(\frac{1}{R} + \frac{1}{\infty} \right)$$

$$\frac{1}{f} = (1.5 - 1) \left(\frac{1}{15} \right) = \frac{1}{30}$$

$$\text{or } f = 30 \text{ cm.}$$

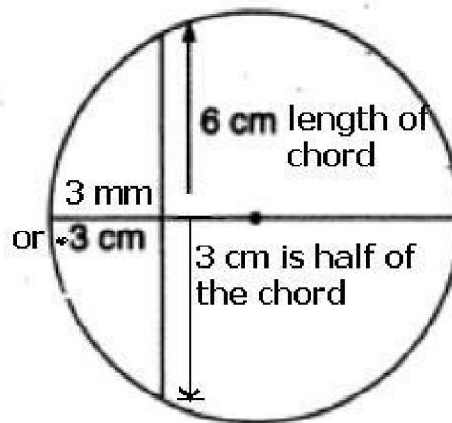

Optics - 18) Spherical lens

A ray of light falls on the surface of a spherical glass paper weight making an angle α with the normal and is refracted in the medium at an angle β . The angle of deviation of the emergent ray from the direction of the incident ray is :

- (a) $(\alpha - \beta)$ (b) $2(\alpha - \beta)$
 (c) $(\alpha - \beta) / 2$ (d) $(\beta - \alpha)$

Newton's Law of Cooling by Prof. Subhashish Chattopadhyay SKMClasses Bangalore Useful for IIT-JEE, CBSE, I.Sc. PU-II, Boards, CET, CEE, PET, IGCSE IB AP-Physics and other exams

$\angle CAB = \angle CBA = \beta$ because in ΔABC

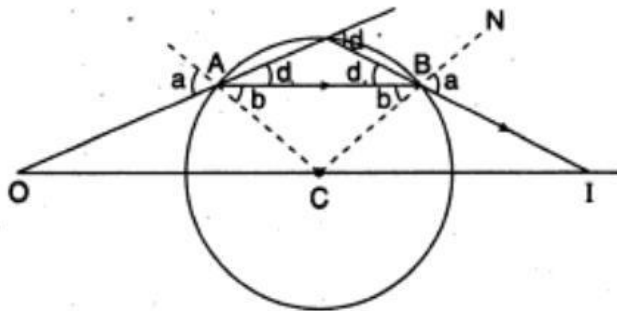

$AC = BC = \text{radius}$
 Naturally $\angle IBN = \alpha$
 $\delta_1 = \alpha - \beta, \delta_2 = \alpha - \beta$
 $\therefore \delta = \delta_1 + \delta_2 = 2(\alpha - \beta)$

A ray is incident on a sphere, with incidence angle of 60° . Refractive Index of the sphere is $\sqrt{3}$. The ray is reflected and refracted on the further surface. The angle between the reflected and refracted surface is ?

Answer 90°

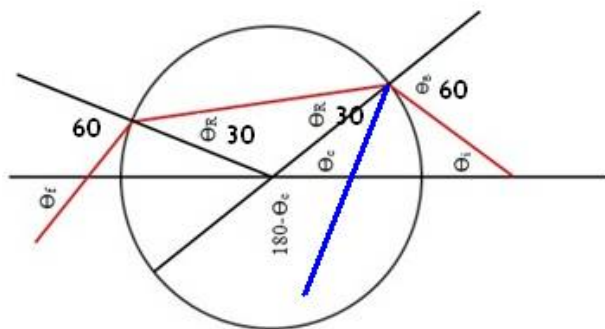

$\sin 60 / \sin r_1 = \sqrt{3} \Rightarrow \sin r_1 = 1/2 \Rightarrow r_1 = 30^\circ$
 $\sin i_2 / \sin r_2 = \sqrt{3} \Rightarrow i_2 = 60^\circ$ as $r_1 = r_2 = 30^\circ$
 Angle of deviation $180 - (r_2 + i_2) = 180 - 90 = 90$

Newton's Law of Cooling by Prof. Subhashish Chattopadhyay SKMClasses Bangalore Useful for IIT-JEE, CBSE, I.Sc. PU-II, Boards, CET, CEE, PET, IGCSE IB AP-Physics and other exams

Optics - 19) Thick lenses

Refraction through Thick Lens

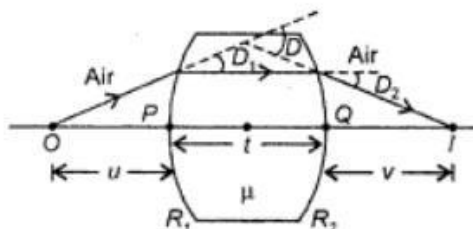

- The focal length of thick lens,

$$\frac{1}{f} = (\mu - 1) \left[\frac{1}{R_1} - \frac{1}{R_2} + \frac{(\mu - 1)t}{\mu R_1 R_2} \right]$$

- Power of thick lens,

$$P = P_1 + P_2 - \frac{P_1 P_2 t}{\mu}$$

Where, P_1 = Power of first refracting surface

$$P_1 = \frac{\mu - 1}{R_1}$$

and P_2 = Power of second refracting surface

$$P_2 = \frac{1 - \mu}{R_2}$$

A convergent thick lens has radii of curvature 10.0 cm and - 6.0 cm, $\mu = 1.60$ and thickness $t = 5.0$ cm. Deduce its focal length.

Solution : Focal length of a lens of thickness t is given by

$$\frac{1}{f} = (\mu - 1) \left[\frac{1}{R_1} - \frac{1}{R_2} + \frac{(\mu - 1)t}{\mu R_1 R_2} \right]$$

Here, $\mu = 1.60$, $R_1 = + 10.0$ cm, $R_2 = - 6.0$ cm and $t = 5.0$ cm.

$$\therefore \frac{1}{f} = (1.60 - 1) \left[\frac{1}{10.0} + \frac{1}{6.0} + \frac{(1.60 - 1) \times 5.0}{1.60 \times 10.0 \times (- 6.0)} \right]$$

$$\text{or} \quad \frac{1}{f} = 0.60 \left[\frac{1}{10} + \frac{1}{6} - \frac{1}{32} \right]$$

$$\Rightarrow \quad f = + 7.14 \text{ cm.}$$

Newton's Law of Cooling by Prof. Subhashish Chattopadhyay SKMClasses Bangalore Useful for IIT-JEE, CBSE, I.Sc. PU-II, Boards, CET, CEE, PET, IGCSE IB AP-Physics and other exams

Optics - 20) Cauchy's formula for Refractive Index

$$n_{25^\circ\text{C}} = A + \frac{B}{\lambda^2} + \frac{C}{\lambda^4}$$

Cauchy's formula for μ

$$n(\lambda) = B + \frac{C}{\lambda^2},$$

Material	B	C (μm^2)
Fused silica	1.4580	0.00354
Borosilicate glass BK7	1.5046	0.00420
Hard crown glass K5	1.5220	0.00459
Barium crown glass BaK4	1.5690	0.00531
Barium flint glass BaF10	1.6700	0.00743
Dense flint glass SF10	1.7280	0.01342

-

Optics - 21) Reflection images in inclined mirrors

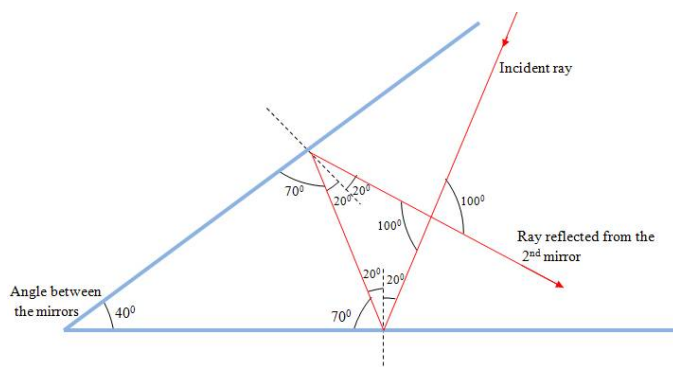
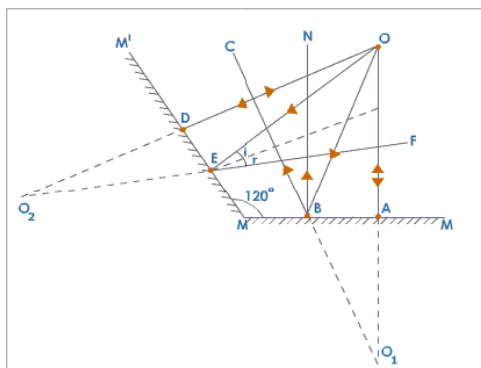

Number of images is given as greatest integer of $[(360/\theta) - 1]$

-

Newton's Law of Cooling by Prof. Subhashish Chattopadhyay SKMClasses Bangalore Useful for IIT-JEE, CBSE, I.Sc. PU-II, Boards, CET, CEE, PET, IGCSE IB AP-Physics and other exams

Optics - 22) Optics problems with vectors, 3D imagination

The x - y plane is boundary between two transparent media. Medium-1 with $z \geq 0$ has a refractive index $\sqrt{2}$ and medium 2 with $z \leq 0$ has refractive index $\sqrt{3}$. A ray of light in medium-1 given by vector $\vec{A} = 6\sqrt{3} \hat{i} + 8\sqrt{3} \hat{j} - 10\hat{k}$ is incident on the plane of separation, find the unit vector in the direction of the refracted ray in medium-2.

Solution: Let refracted ray be $\vec{r} = a\hat{i} + b\hat{j} - c\hat{k}$

$$\text{Normal to plane of incident and normal} = \begin{vmatrix} \hat{i} & \hat{j} & \hat{k} \\ 6\sqrt{3} & 8\sqrt{3} & -10 \\ 0 & 0 & 1 \end{vmatrix}$$

$$= 8\sqrt{3} \hat{i} - 6\sqrt{3} \hat{j}$$

it must also be normal to refracted ray

$$\begin{aligned} \therefore \vec{r} \cdot \vec{n} &= 0 \\ \Rightarrow 8\sqrt{3} a - 6\sqrt{3} b &= 0 \Rightarrow 4a = 3b \\ \Rightarrow b &= \frac{4a}{3} \end{aligned}$$

$$\begin{aligned} \therefore \cos(\pi - i) &= \frac{(6\sqrt{3} \hat{i} + 8\sqrt{3} \hat{j} - 10\hat{k}) \cdot \hat{k}}{\left| 6\sqrt{3} \hat{i} + 8\sqrt{3} \hat{j} - 10\hat{k} \right| \left| \hat{k} \right|} \\ &= \frac{-10}{20} = \cos 120^\circ \\ \therefore i &= 60^\circ \end{aligned}$$

$$\sqrt{3} \sin r = \sqrt{2} \sin i = \sqrt{2} \times \frac{\sqrt{3}}{2} \Rightarrow \sin r = \frac{1}{\sqrt{2}}$$

Newton 's Law of Cooling by Prof. Subhashish Chattopadhyay SKMClasses Bangalore Useful for IIT-JEE, CBSE, I.Sc. PU-II, Boards, CET, CEE, PET, IGCSE IB AP-Physics and other exams

$$r = 45^\circ$$

Now since angle between refracted ray and Normal = 45°

$$\therefore \cos 45^\circ = \frac{(a\hat{i} + b\hat{j} + c\hat{k}) \cdot \hat{k}}{\sqrt{a^2 + b^2 + c^2}} = \frac{1}{\sqrt{2}}$$

$$\Rightarrow \sqrt{2} c = \sqrt{a^2 + b^2 + c^2}$$

$$\Rightarrow c^2 = a^2 + b^2 = a^2 + \frac{16a^2}{a} = \frac{25a^2}{a}$$

$$\Rightarrow c = \frac{\pm 5a}{3}$$

$$\therefore c = \frac{-5a}{3}$$

$$\therefore r = a\hat{i} + \frac{4a}{3}\hat{j} - \frac{5a}{3}\hat{k} = \frac{a}{3}(3\hat{i} + 4\hat{j} - 5\hat{k})$$

$$r = \frac{3\hat{i} + 4\hat{j} - 5\hat{k}}{\sqrt{50}} = \frac{1}{5\sqrt{2}}(3\hat{i} + 4\hat{j} - 5\hat{k})$$

Optics - 23) Problems with continuously varying refractive index (First asked in IPhO and then in IIT JEE)

A ray of light in air is incident at grazing angle ($i = 90^\circ$) on a long rectangular slab of a transparent medium of thickness $t = 1.0$ m. The point of incidence is the origin $A(0, 0)$.

The medium has a variable index of refraction $n(y)$ given by $n(y) = \sqrt{ky^{3/2} + 1}$ where $k = 1.0 \text{ m}^{-3/2}$.

The refractive index of air is 1. (i) Obtain a relation between the slope of the trajectory of the ray at a point $B(x, y)$ in the point. (ii) Obtain an equation for trajectory $y(x)$ of the ray in

Newton 's Law of Cooling by Prof. Subhashish Chattopadhyay SKMClasses Bangalore Useful for IIT-JEE, CBSE, I.Sc. PU-II, Boards, CET, CEE, PET, IGCSE IB AP-Physics and other exams

Newton's Law of Cooling by Prof. Subhashish Chattopadhyay SKMClasses Bangalore Useful for IIT-JEE, CBSE, I.Sc. PU-II, Boards, CET, CEE, PET, IGCSE IB AP-Physics and other exams

the point. (iii) Determine the co-ordinates (x, y_1) of the point P where the ray intersects the upper surface of the slab-air boundary. (d) Indicate the path of the ray subsequently.

Solution:

Taking on arbitrary point P(x, y) refractive index at this point $n = \left(y^{3/2} + 1\right)^{1/2}$

from Snell's law $n \sin \theta = \text{constant}$ applying this for initial pt. (when ray is entering medium B) and at point.

$$1 \times \sin 90^\circ = \sqrt{\left(y^{3/2} + 1\right)} \sin i$$

$$\Rightarrow \sin i = \frac{1}{\sqrt{y^{3/2} + 1}} \quad \text{it can be seen that } i = \frac{\pi}{2} - \theta$$

$$\therefore \text{Slope} = \tan \theta = \cot i = \frac{dy}{dx}$$

$$(ii) \frac{dy}{dx} = \cot i = \frac{y^{3/4}}{1}$$

$$\Rightarrow \int y^{-3/4} dy = \int dx$$

$$\Rightarrow x = 4y^{1/4} + C$$

it passes through origin $\therefore C = 0$

$\therefore x = 4y^{1/4}$ is the equation of trajectory

when ray comes out of the mediums

then $x = 4 \times 1 = 4$

\therefore Co-ordinate of pt- is (4, 1)

If medium on both sides are same, then angle with which the ray enters the medium = angle with which the ray comes out.

\therefore Ray will be parallel to x-axis.

Newton's Law of Cooling by Prof. Subhashish Chattopadhyay SKMClasses Bangalore Useful for IIT-JEE, CBSE, I.Sc. PU-II, Boards, CET, CEE, PET, IGCSE IB AP-Physics and other exams

A cubic container is filled with a liquid whose refractive index increases linearly from top to bottom. Which of the following represents the path of a ray of light inside the liquid?

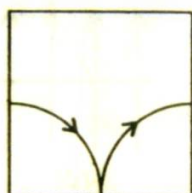

(a)

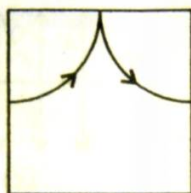

(b)

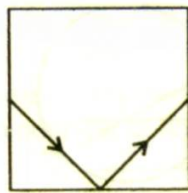

(c)

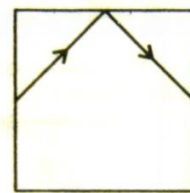

(d)

Since the refractive index is changing, the light cannot travel in a straight line in the liquid as shown in options (c) and (d). Initially, it will bend towards normal and after reflecting from the bottom it will bend away from the normal as shown in the figure.

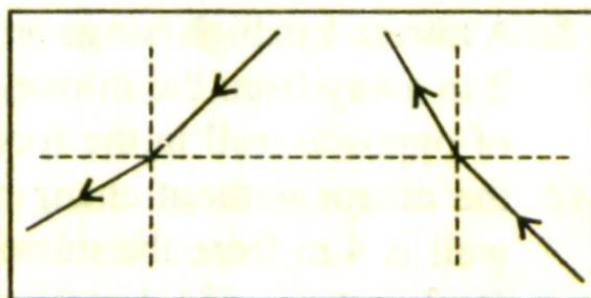

Optics - 24) Cylindrical lens (IIT JEE 1999)

A thin slice is cut out of a glass cylinder along a plane parallel to its axis. The slice is placed on a flat plate . The observed interference fringes from this combination shall be

1. Straight
2. Circular
3. Equally spaced
4. Having fringe spacing which increases as we go outwards

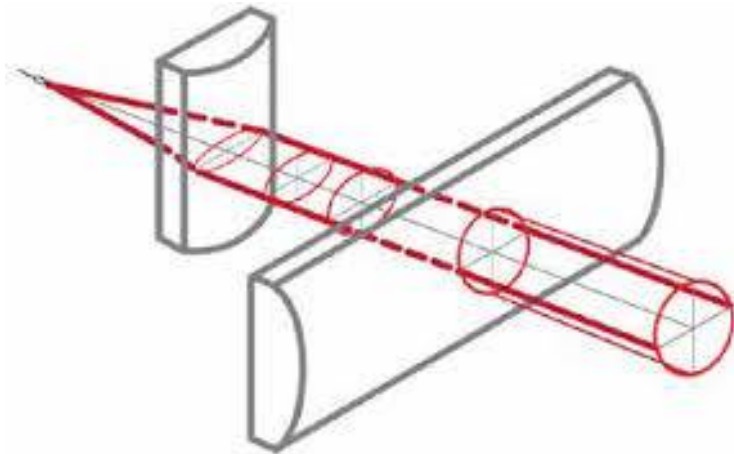

Cylindrical Lens: Cylindrical lens is a section of a cylindrical rod. One surface is cylindrical while the opposite is plane.

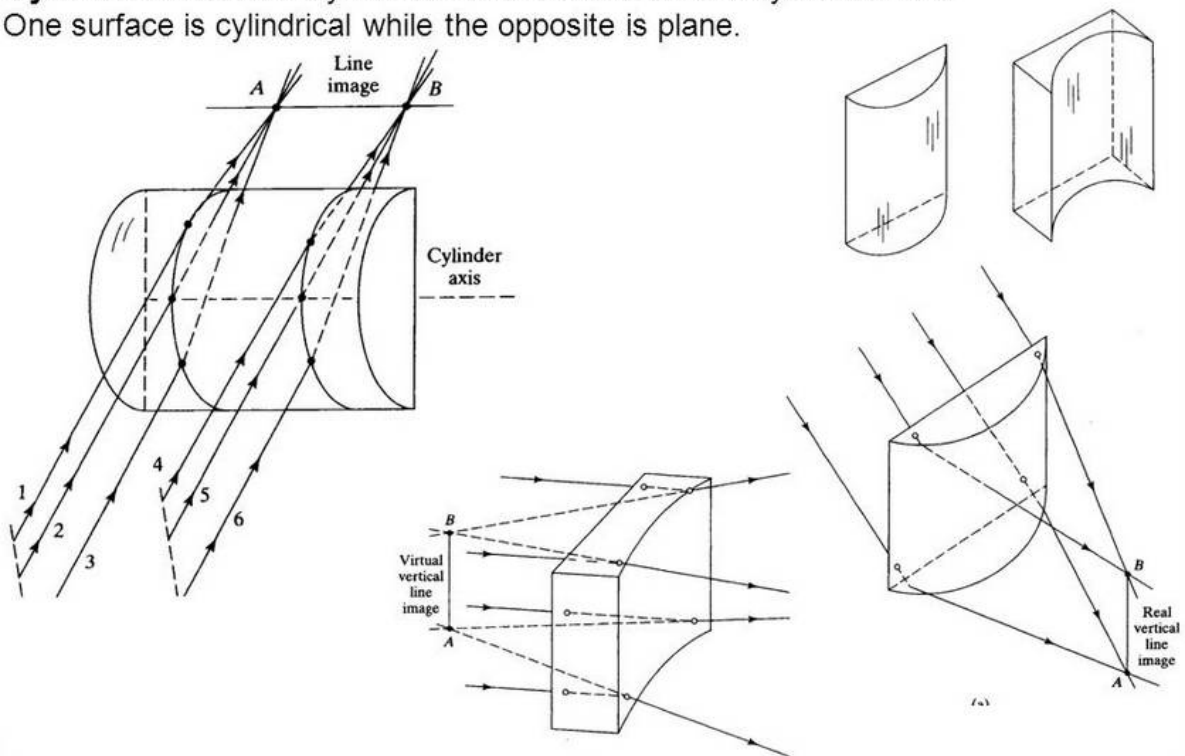

Optics - 25) Two lenses or mirrors whose axis is not coinciding (IIT JEE 1993) Shifted lenses or mirrors

Two thin convex lenses of focal lengths f_1 and f_2 are separated by a horizontal distance d (where $d < f_1, d < f_2$) and their centres are displaced by a vertical separation Δ as shown in the figure. (1993)

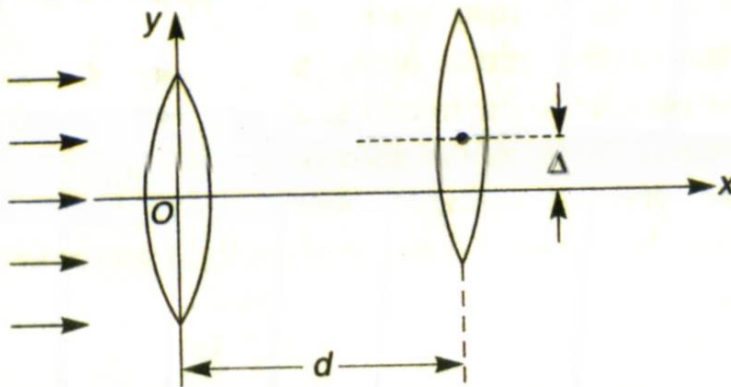

Taking the origin of coordinates, O , at the centre of the first lens, the x and y -coordinates of the focal point of this lens system, for a parallel beam of rays coming from the left, are given by (1993; 2M)

(a) $x = \frac{f_1 f_2}{f_1 + f_2}, y = \Delta$

(b) $x = \frac{f_1(f_2 + d)}{f_1 + f_2 - d}, y = \frac{\Delta}{f_1 + f_2}$

(c) $x = \frac{f_1 f_2 + d(f_1 - d)}{f_1 + f_2 - d}, y = \frac{\Delta(f_1 - d)}{f_1 + f_2 - d}$

(d) $x = \frac{f_1 f_2 + d(f_1 - d)}{f_1 + f_2 - d}, y = 0$

Solution

From the first lens parallel beam of light is focused at its focus *i.e.*, at a distance f_1 from it. This image I_1 acts as virtual object for second lens L_2 . Therefore, for L_2

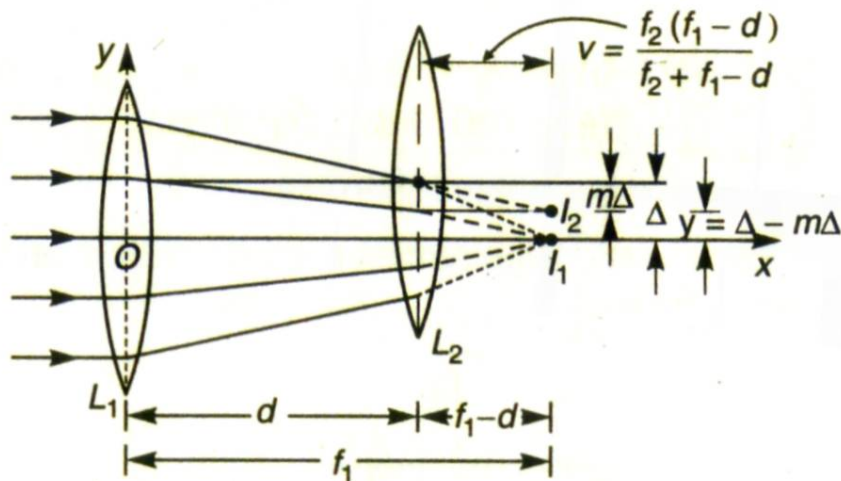

$$u = + (f_1 - d), f = + f_2$$

$$\therefore \frac{1}{v} = \frac{1}{f} + \frac{1}{u} = \frac{1}{f_2} + \frac{1}{f_1 - d}$$

<https://archive.org/details/IITJEE1993OpticsInterestingShiftedLensImageMagnificationAndPosition>

Find the co-ordinates of image of point object P formed after two successive reflection in situation as shown in fig. considering first reflection at concave mirror and then at convex mirror.

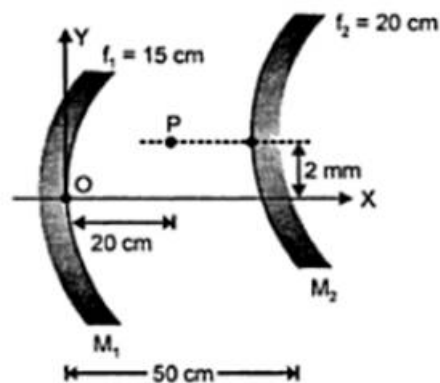

So $f_1 = -15$ cm

$$v_1 = \frac{u \cdot f_1}{u - f_1} = \frac{(-20)(-15)}{-20 + 15}$$

or

$$v_1 = -60 \text{ cm}$$

$$\text{Magnification } (m_1) = -\frac{v_1}{u} = -\frac{-60}{-20} = -3 \quad (\text{Inverted})$$

$$\therefore A'P' = m_1 (AP) = 3 \times 2 = 6 \text{ mm}$$

For reflection at convex mirror M_2

$$u = +10 \text{ cm}$$

$$f_2 = +20 \text{ cm}$$

$$v_2 = \frac{u \cdot f_2}{u - f_2} = \frac{(10)(20)}{10 - 20} = -20 \text{ cm}$$

$$\text{Magnification } m_2 = -\frac{v_2}{u} \Rightarrow -\frac{-20}{10} \Rightarrow 2$$

$$\therefore C'P' = m_2 (C'P) = 2 \times 8 = 16 \text{ mm}$$

So, the co-ordinate of image of point object P (30 cm, -14 mm).

Optics - 26) Painted lens or Combination of lenses where the last one is painted (silvered)

If I am recalling correctly IIT JEE and other exams (till 2016) had more than 10 questions of this kind. Most books do not discuss the easy formula of $-1/F = 2/f_{L1} + 2/f_{L2} - 1/f_m$

(In 1990 I had derived this formula of my own for quick solving of this kind of problems)

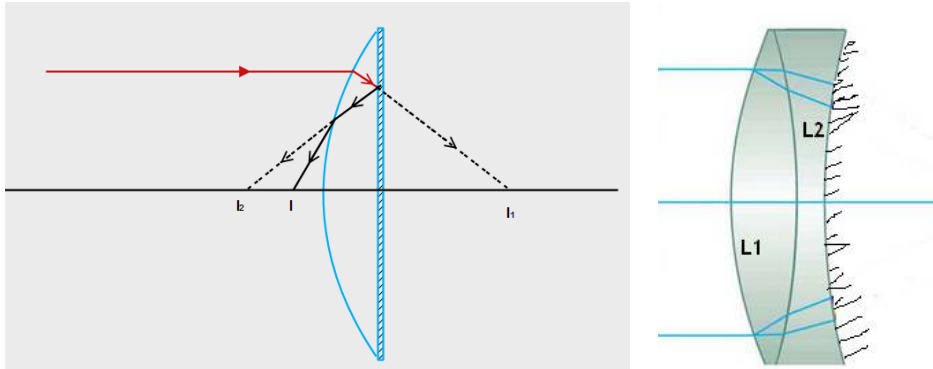

F_m is focal length of the mirror as $R/2$ +ve or -ve as per conditions

The plane face of a plano-convex lens is silvered. If μ be the refractive index and R , the radius of curvature of curved surface, then the system will behave like a concave mirror of radius of curvature:

- (a) μR (b) $R/(\mu - 1)$
 (c) R^2/μ (d) $[(\mu + 1)/(\mu - 1)]R$

Solution :

Focal length of planar side is $f_m = R/2 = -\infty$

$\frac{1}{f_l} = (\mu - 1) \left(\frac{1}{R} \right)$ by lens makers formula. R is positive because center of curvature is on right side

Use $-1/F = 2/f_{L1} - 1/f_m$ or $1/F = -\frac{2(\mu - 1)}{R}$ or $F = \frac{-R}{2(\mu - 1)}$

R (equivalent) = $2F = \frac{-R}{(\mu - 1)}$

We don't have to use the formula $-1/F = 2/f_{L1} + 2/f_{L2} - 1/f_m$ for every problem

See a Karnataka CET problem of 2004 (Was also asked in IIT JEE and solved in "Concepts of Physics by Professor H C Verma)

A thin plano-convex lens acts like a concave mirror of focal length 0.2 m, when silvered on its plane surface. The refractive index of the material of lens is 1.5. The radius of curvature of the convex surface of the lens will be:

[CET (Karnataka) 2004]

- (a) 0.1 m (b) 0.2 m (c) 0.4 m (d) 0.8 m

Solution :

Given focal length of mirror when its plane surface is silvered (f_m) = 0.2 m. Radius of curvature of curved surface (R_1) = R ; radius of curvature of plane side (R_2) = ∞ ; refractive index of the material of lens (μ) = 1.5.

Since a thin plano-convex lens acts like a concave mirror when silvered on its plane surface, therefore focal length of lens (f) = $2 \times f_m = 2 \times 0.2 = 0.4$ m.

We know that

$$\frac{1}{f} = (\mu - 1) \left(\frac{1}{R_1} - \frac{1}{R_2} \right)$$

or

$$\frac{1}{0.4} = (1.5 - 1) \left(\frac{1}{R} - \frac{1}{\infty} \right) = \frac{0.5}{R}$$

\therefore $R = 0.2 \text{ m}$

IIT JEE 2006

A point object is placed at a distance of 20 cm from a thin planoconvex lens of focal length 15 cm. The plane surface of the lens is now silvered. The image created by the system is at (2006, 3M)

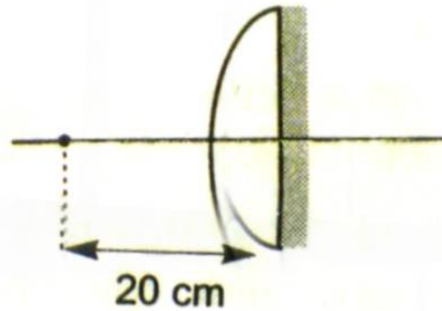

- (a) 60 cm to the left of the system
- (b) 60 cm to the right of the system
- (c) 12 cm to the left of the system
- (d) 12 cm to the right of the system

Solution :

Long method

$$\text{Refraction from lens : } \frac{1}{v_1} - \frac{1}{-20} = \frac{1}{15}$$

$$\therefore v = 60 \text{ cm} \quad \xrightarrow{\text{+ ve direction}}$$

ie, first image is formed at 60 cm to the right of lens system.

Reflection from mirror

After reflection from the mirror, the second image will be formed at a distance of 60 cm to the left of lens system.

Refraction from lens

$$\frac{1}{v_3} - \frac{1}{60} = \frac{1}{15} \quad \xleftarrow{\text{+ ve direction}}$$

or $v_3 = 12 \text{ cm}$

Therefore, the final image is formed at 12 cm to the left of the lens system.

Shorter Method

$$\frac{1}{f} = (\mu - 1) \left(\frac{1}{R_1} - \frac{1}{R_2} \right)$$

$$\text{Use } F = \frac{-R}{2(\mu - 1)} \quad \text{and} \quad (1.5 - 1) \left(\frac{1}{R} - \frac{1}{\infty} \right) = \frac{0.5}{R} = 1/(2R)$$

$$1/15 = 1/2R \Rightarrow 15 = 2R \Rightarrow R = 7.5 \text{ cm}$$

$$F = -7.5 / (2 \times 0.5) = -7.5 = -15/2$$

Using $1/v + 1/u = 1/F$ for equivalent mirror

$$1/v + 1/(-20) = 1/(-7.5)$$

$$\Rightarrow 1/v = 1/20 - 2/15 = (3 - 8)/60 = -5/60 = -1/12$$

$$\Rightarrow v = -12 \text{ cm}$$

Even more shorter method

If I am appearing for an exam I would have done $-1/F = 2/f_{L1} - 1/f_m$

$$\text{So } -1/F = 2/(15) - 1/(\infty) = 1/7.5 - 0 \Rightarrow F = -7.5 \text{ cm}$$

Then Using $1/v + 1/u = 1/F$ for equivalent mirror

$$1/v + 1/(-20) = 1/(-7.5)$$

$$\Rightarrow 1/v = 1/20 - 2/15 = (3 - 8)/60 = -5/60 = -1/12$$

$$\Rightarrow v = -12 \text{ cm}$$

-

IIT JEE 1978

A pin is placed 10 cm in front of a convex lens of focal length 20 cm and made of a material of refractive index 1.5. The convex surface of the lens farther away from the pin is silvered and has a radius of curvature of 22 cm. Determine the position of the final image. Is the image real or virtual ? (1978)

Let us use $-1/F = 2/f_{L1} - 1/f_m$

And $\frac{1}{f} = (\mu - 1) \left(\frac{1}{R_1} - \frac{1}{R_2} \right)$ giving $1/20 = 0.5 (1/R_1 - 1/(-22))$ or $R_1 = 55/3$

R_1 actually is not required. We can find f_m as $R_2 / 2 = - 11$ cm

So $- 1/F = 2/20 - 1/(-11) = 1/10 + 1/11 = 21/110$

or $F = - 110/21$ (not required ! $1/F = -21/110$ is enough)

Using mirror formula $1/v + 1/u = 1/F$

So $1/v + 1 / (-10) = -21/110$

$\Rightarrow 1/v = 1/10 - 21/110 = (11 - 21)/110 = -10/110 = -1/11$

$\Rightarrow v = -11$ cm

virtual image on left at 11 cm

(Now do you guys see that even though we got problems of this kind since 1978 and before, but yet the formula is not there in every book !)

-

IIT JEE 1979

The radius of curvature of the convex face of a planoconvex lens is 12 cm and its $\mu = 1.5$.

- (a) Find the focal length of the lens. The plane face of the lens is now silvered.**
 - (b) At what distance from the lens will parallel rays incident on the convex surface converge ?**
 - (c) Sketch the ray diagram to locate the image, when a point object is placed on the axis 20 cm from the lens.**
 - (d) Calculate the image distance when the object is placed as in (c)**
- (1979)**

Now you know that this problem can be solved by 3 different ways.

The longest method being successive image method. Meaning find the first image due to lens, then 2nd image due to silvered surface as mirror. The 3rd and final image is due to light travelling from right to left through the lens again.

I will discuss the shorter methods

$$\begin{aligned} \text{(a)} \quad \frac{1}{f} &= (\mu - 1) \left(\frac{1}{R_1} - \frac{1}{R_2} \right) \\ &= (1.5 - 1) \left(\frac{1}{12} - \frac{1}{\infty} \right) \\ &= \frac{1}{24} \\ \therefore f &= +24 \text{ cm} \end{aligned}$$

(b) use $-1/F = 2/f_L$ so $F = -12$ cm

The system will act as a concave mirror of focal length 12 cm. The parallel rays will converge at 12 cm left of this silvered lens.

(c)

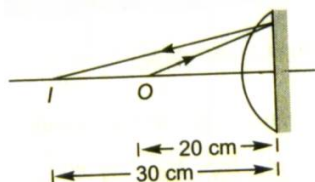

(d)

Using mirror formula

$$\frac{1}{v} - \frac{1}{20} = \frac{-1}{12}$$

Solving we get $v = -30$ cm.

Therefore the image will be formed at a distance of 30 cm to the left of system.

IIT JEE 1981

The convex surface of a thin concavo-convex lens of glass of refractive index 1.5 has a radius of curvature

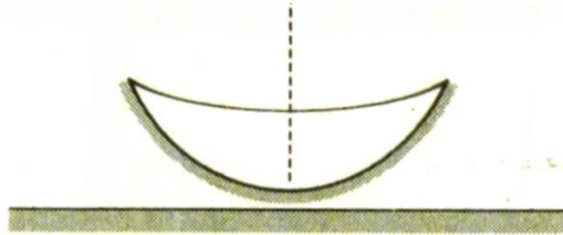

20 cm. The concave surface has a radius of curvature 60 cm. The convex side is silvered and placed on a horizontal surface. **(1981, 2M)**

- (a) Where should a pin be placed on the optic axis such that its image is formed at the same place?
- (b) If the concave part is filled with water of refractive index $\frac{4}{3}$, find the distance through which the pin should be moved, so that the image of the pin again coincides with the pin.

I will prefer to solve this by $-1/F = 2/f_{L1} + 2/f_{L2} - 1/f_m$ (note it was a 2 marks problem)

While for practice and to know how successive image method of solving works see ...

Image of object will coincide with it if ray of light after refraction from the concave surface fall normally on concave mirror so formed by silvering the convex surface. Or image after refraction from concave surface should form at centre of curvature of concave mirror or at a distance of 20 cm on same side of the combination. Let x be the distance of pin from the given optical system.

Applying.

$$\frac{\mu_2}{v} - \frac{\mu_1}{u} = \frac{\mu_2 - \mu_1}{R}$$

With proper signs

$$\frac{1.5}{-20} - \frac{1}{-x} = \frac{1.5 - 1}{-60}$$

or
$$\frac{1}{x} = \frac{3}{40} - \frac{1}{120} = \frac{8}{120}$$

$\therefore x = \frac{120}{8} = 15 \text{ cm}$

(b)

Now, before striking with the concave surface, the ray is first refracted from a plane surface. So, let x be the distance of pin, then the plane surface will form its image at a distance $\frac{4}{3}x$ ($h_{\text{app.}} = \mu h$) from it.

Now, using $\frac{\mu_2}{v} - \frac{\mu_1}{u} = \frac{\mu_2 - \mu_1}{R}$ with proper signs,

we have
$$\frac{1.5}{-20} - \frac{4/3}{-4x} = \frac{1.5 - 4/3}{-60}$$

or
$$\frac{1}{x} = \frac{3}{40} - \frac{1}{360}$$

or
$$x = 13.84 \text{ cm}$$

$\therefore \Delta x = x_1 - x_2$
 $= 15 \text{ cm} - 13.84 \text{ cm}$
 $= 1.16 \text{ cm} \quad \text{(downwards)}$

Now can you guys check the results using $-1/F = 2/f_{L1} + 2/f_{L2} - 1/f_m$

A plano-convex lens of refractive index 1.5 and radius of curvature 30 cm is silvered at the curved surface. Now this lens has been used to form the image of an object. At what distance from this lens an object be placed in order to have a real image of the size of the object? (AIEEE 2004)

- (a) 20 cm (b) 30 cm
(c) 60 cm (d) 80 cm

Solution :

To obtain the real image of the size of the object, the object must be placed at the centre of curvature of the equivalent mirror formed as a result of silvering

$$\frac{1}{F} = \frac{2}{f_l} + \frac{1}{f_m}$$

$$\text{and } \frac{1}{f_l} = (1.5 - 1) \left(\frac{1}{\infty} - \frac{1}{-30} \right) = \frac{1}{60}$$

$$\text{and } f_m = 15 \text{ cm}$$

$$\therefore F = 10 \text{ cm}$$

Hence, object should be placed at 20 cm from the lens because radius of curvature of equivalent mirror = $2F = 2 \times 10 = 20$ cm. Hence, option (a) is correct.

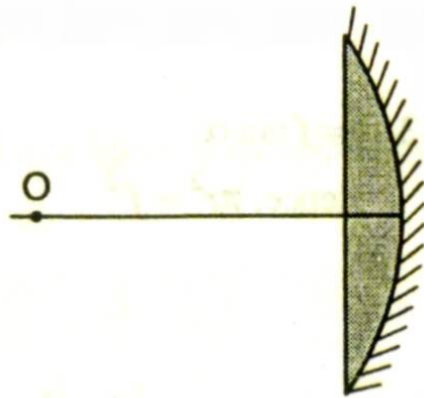

Video explanations of Painted or Silvered lenses

<https://archive.org/details/PaintedLensIITJEEProblemImageNeedsToCoincideWithObjectHCVPof.HCVermaPart1>

Optics - 27) Image speed when object is moving as seen from various mirrors and lenses

(concave, convex, silvered etc)

Mirror formula ($1/v + 1/u = 1/f$) or Lens formula ($1/v - 1/u = 1/f$) have to be differentiated to find du/dt or dv/dt

A luminous point is moving at speed v_0 towards a spherical mirror, along its axis. Then the speed at which the image of this point object is moving is given by: (with R = radius of curvature and u = object distance)

(a) $v_i = -v_0$ (b) $v_i = -v_0 \left(\frac{R}{2u - R} \right)$
(c) $v_i = -v_0 \left(\frac{2u - R}{R} \right)$ (d) $v_i = -v_0 \left(\frac{R}{2u - R} \right)^2$

$$\frac{1}{v} + \frac{1}{u} = \frac{1}{f} \quad \text{or} \quad -\frac{1}{v^2} \frac{dv}{dt} - \frac{1}{u^2} \frac{du}{dt} = 0$$

$$\therefore \quad \frac{dv}{dt} = v_i = -\left(\frac{v}{u}\right)^2 \frac{du}{dt} = -\left(\frac{v}{u}\right)^2 v_0$$

Now, $\frac{1}{v} = \frac{1}{f} - \frac{1}{u} = \frac{2}{R} - \frac{1}{u} = \frac{2u - R}{Ru}$

$$\therefore \quad v = \frac{uR}{2u - R}$$

$$\therefore \quad v_i = -\left(\frac{v}{u}\right)^2 v_0 = -v_0 \left(\frac{R}{2u - R}\right)^2$$

Optics - 28) Slab with a hole or gap, then may be filled with liquid etc

Given ${}^a\mu_g = 3/2$ and ${}^a\mu_w = 4/3$. There is an equiconvex lens with radius of each surface equal to 20 cm. There is air in the object space and water in the image space. The focal length of lens is:

- (a) 80 cm (b) 40 cm (c) 20 cm (d) 10 cm

Solution :

$$\begin{aligned}\frac{{}^a\mu_w}{f} &= \frac{({}^a\mu_g - 1)}{R_1} - \frac{({}^a\mu_g - {}^a\mu_w)}{R_2} \\ &= \frac{\left(\frac{3}{2} - 1\right)}{20} - \frac{\left(\frac{3}{2} - \frac{4}{3}\right)}{-20} = \frac{1}{40} + \frac{1}{120} = \frac{1}{30} \\ f &= \frac{4}{3} \times 30 = 40 \text{ cm}\end{aligned}$$

Optics - 29) Constraint in interference conditions

Two identical coherent sources are placed on a diameter of a circle of radius R at separation x ($\ll R$) symmetrically about the centre of the circle. The sources emit identical wavelength λ each. The number of points on the circle with maximum intensity is: ($x = 5\lambda$)

- (a) 20 (b) 22 (c) 24 (d) 26

Solution :

Path difference at P is

$$\Delta x = 2 \left(\frac{x}{2} \cos \theta \right) = x \cos \theta$$

For intensity to be maximum,

$$\Delta x = n\lambda$$

$$(n = 0, 1, 2, \dots)$$

$$\therefore x \cos \theta = n\lambda$$

$$\cos \theta = \frac{n\lambda}{x}$$

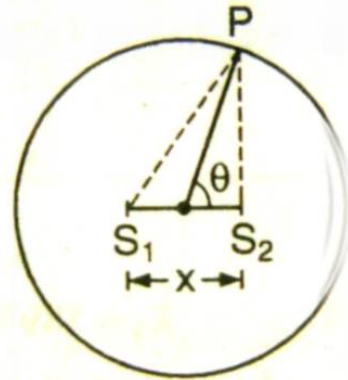

$$\cos \theta \neq 1$$

$$\therefore \frac{n\lambda}{x} \neq 1$$

$$\therefore n \neq \frac{x}{\lambda}$$

Putting $x = 5\lambda$, $n \neq 5$

or $n = 1, 2, 3, 4, 5$

Therefore in all four quadrants there can be 20 maximas. There are

more maximas at $\theta = 0^\circ$ and $\theta = 180^\circ$.

But $n = 5$ corresponds to $\theta = 90^\circ$ and $\theta = 270^\circ$ which are coming only twice while we have multiplied it four times. Therefore, total number of maximas are still 20, i.e., $n = 1$ to 4 in four quadrants (total 16) plus four more at $\theta = 0^\circ, 90^\circ, 180^\circ$ and 270° .

If two coherent sources are placed at a distance 3λ from each other symmetric to the centre of the circle shown in the figure, then number of fringes shown on the screen placed along the circumference is: **(UPSEAT 2002)**

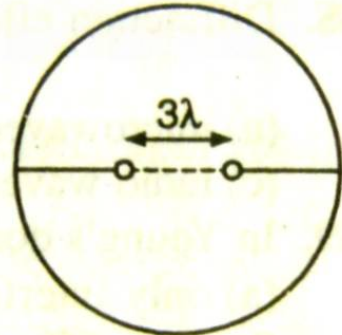

- (a) 16
- (b) 12
- (c) 8
- (d) 4

Answer (b) See above Solution

White light is used to illuminate the two slits in a Young's double slit experiment. The separation between the slits is b and the screen is at a distance $d (\gg b)$ from the slits. At a point on the screen directly in front of one of the slits, certain wavelengths are missing. Some of these missing wavelengths are: **[CET (J&K) 2003; PET (Kerala) 2006]**

- (a) $\lambda = 3b^2/d$
- (b) $\lambda = 2b^2/d$
- (c) $\lambda = b^2/3d$
- (d) $\lambda = 2b^2/3d$

Solution :

$$\text{Path difference} = (S_2P - S_1P)$$

$$\text{From figure, } (S_2P)^2 - (S_1P)^2 = b^2$$

$$\text{or } (S_2P - S_1P)(S_2P + S_1P) = b^2$$

$$\text{or } (S_2P - S_1P) = \frac{b^2}{2d}$$

$$\text{For dark fringes, } \frac{b^2}{2d} = (2n + 1) \frac{\lambda}{2}$$

$$\text{For } n = 0, \quad \frac{b^2}{2d} = \frac{\lambda}{2} \quad \text{or } \lambda = \frac{b^2}{d}$$

$$\text{For } n = 1, \quad \frac{b^2}{2d} = \frac{3\lambda}{2} \quad \text{or } \lambda = \frac{b^2}{3d}$$

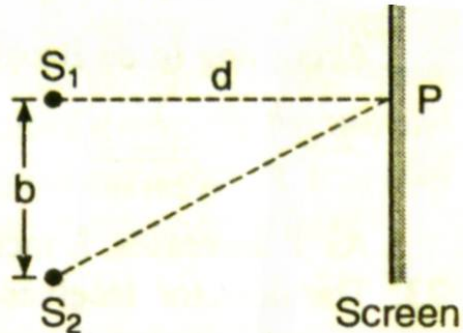

Optics - 30) Silvered Prisms or Painted Prisms

If one face of a prism of prism angle 30° and $\mu = \sqrt{2}$ is silvered, the incident ray retraces its initial path. The angle of incidence is:

- (a) 60° (b) 30° (c) 45° (d) 90°

Solution : (c)

It is clear from the figure that the ray will retrace the path when the refracted ray QR is incident normally on the polished surface AC . Thus, angle of refraction $r = 30^\circ$.

We know that $\mu = \sin i / \sin r$

$$\therefore \sin i = \mu \sin r$$

$$= \sqrt{2} \times \sin 30^\circ = \sqrt{2} \times \frac{1}{2}$$

$$= (1/\sqrt{2})$$

$$\therefore i = 45^\circ$$

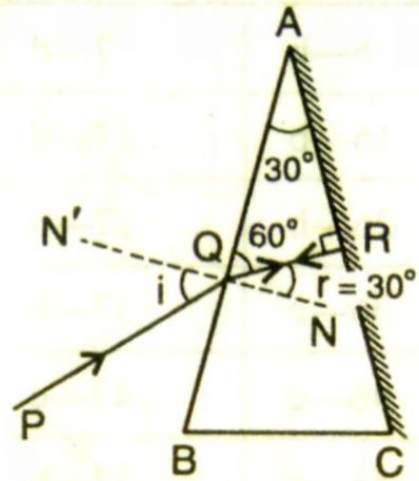

Optics - 31) A slab is silvered on one side or Painted on one side

A plane mirror is made of a glass slab ($\mu_g = 1.5$) 2.5 cm thick and silvered on its back. A point object is placed 5 cm in front of the unsilvered face of the mirror. What will be the position of the final image?

- (a) 12 cm from unsilvered face
- (b) 14.6 cm from unsilvered face
- (c) 5.67 cm from unsilvered face
- (d) 8.33 cm from unsilvered face

Solution : (d)

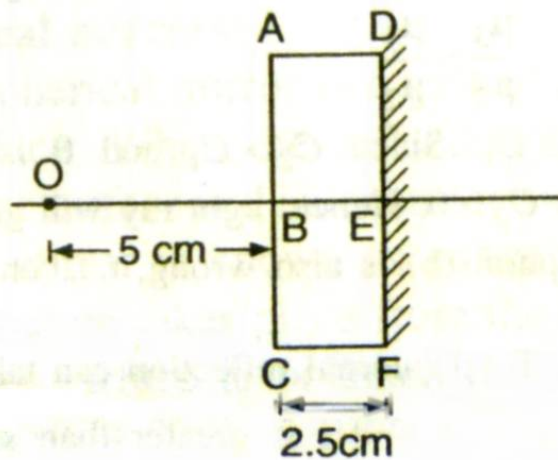

Let I_1 , I_2 and I_3 be the images formed by

- (i) refraction from ABC
- (ii) reflection from DEF and
- (iii) again refraction from ABC

Then $BI_1 = (5)\mu_g = 5 \times 1.5 = 7.5 \text{ cm}$

Now $EI_1 = 7.5 + 2.5 = 10 \text{ cm}$

$\therefore EI_2 = 10 \text{ cm}$ behind the mirror

Now, $BI_2 = (10 + 2.5) = 12.5 \text{ cm}$

$\therefore BI_3 = \frac{12.5}{\mu_g} = \frac{12.5}{1.5} = 8.33 \text{ cm}$

Real and apparent depth:

- (i) When one looks into a pool of water, it does not appear to be as deep as it really is. Also when one looks into a slab of glass, the material does not appear to be as thick as it really is. This all happens due to refraction of light.
- ii) If a beaker is filled with water and a point lying at its bottom is observed by someone located in air, then the bottom point appears raised. The apparent depth t_{ap} is less than the actual depth t_{ac} . It can be shown that

$$\text{apparent depth } (t_{ap}) = \frac{\text{actual depth } (t_{ac})}{\text{refractive index } (n)}$$

iii)

If there is an ink spot at the bottom of a glass slab, it appears to be raised by a distance

$$d = t_{ac} - t_{ap} = t - \frac{t}{n} = t \left(1 - \frac{1}{n} \right)$$

where t is the thickness of the glass slab and n is its refractive index.

A beaker containing liquid is placed on a table, underneath a microscope which can be moved along a vertical scale. The microscope is focussed through the liquid on to a mark on

the table when the reading on the scale is a . It is next focussed on the upper surface of the liquid and the reading is b . More liquid is added and the observations are repeated, the corresponding readings are c and d . The refractive index of the liquid is:

(a) $\frac{d-b}{d-c-b+a}$

(b) $\frac{b-d}{d-c-b+a}$

(c) $\frac{d-c-b+a}{d-b}$

(d) $\frac{d-b}{a+b-c-d}$

Solution : (a)

The real depth = R.I. \times apparent depth

In first case,

The real depth $h_1 = n(b - a)$

Similarly, in the second case, the real depth $h_2 = n(d - c)$

Since, $h_2 > h_1$, the difference of real depths

$$= h_2 - h_1 = n(d - c - b + a)$$

Since the liquid is added in second case,

$$h_2 - h_1 = d - b$$

$$\therefore n = \frac{d - b}{d - c - b + a}$$

Optics - 32) In YDSE experiment the light falls at an angle on 2 slits

Example: Recalculate the angular spread to the above problem if the incidence is at an angle of 15° with the normal to the plane of the slit.

Solution. (a) Let us first consider a point P (above centre O of the screen) on the screen as shown in Fig. From B, drop a perpendicular BN' . From A, drop a perpendicular AN on BP. If first minimum is formed at P, then the corresponding path difference is given by

$$BN - AN' = \lambda$$

$$BN - AN' = \lambda$$

or $d \sin \theta_1 - d \sin 15^\circ = \lambda$

or $\sin \theta_1 - \sin 15^\circ = \frac{\lambda}{d} = \frac{2 \text{ cm}}{5 \text{ cm}} = 0.4$

or $\sin \theta_1 = 0.4 + \sin 15^\circ = 0.4 + 0.2588 = 0.6588$

or $\theta_1 = \sin^{-1}(0.6588) = 41^\circ 13'$ (from tables of natural sines)

(b) Let us now consider a point P' below O. Let the first minimum be at P'. Then, the corresponding path difference is given by

$$N'A + AN = \lambda \quad \text{or} \quad d \sin 15^\circ + d \sin \theta_2 = \lambda$$

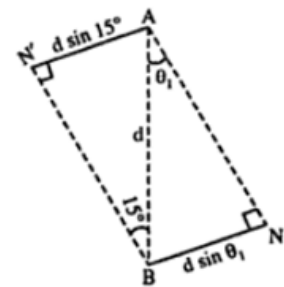
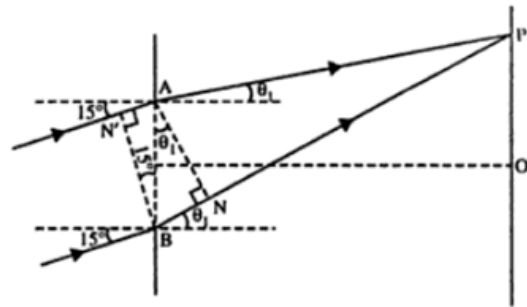

Optics - 33) Diffraction Grating

Example A diffraction grating one cm wide has 1000 lines and is used in third order. What are the diffraction angles for violet and orange light? What is the angular size of the diffraction maximum for monochromatic light? The wavelengths for violet and orange are 400 nm and 600 nm respectively.

Solution. For third order, $n = 3$, $\theta_v = \frac{3 \times 4 \times 10^{-7}}{10^{-5}} \text{ rad} = 12 \times 10^{-2} \text{ rad} = 6.9^\circ$
 $\theta_o = 18 \times 10^{-2} \text{ rad} = 10.3^\circ$

The spectrum is thus spread over an angle of nearly 3.4° .

At a maximum, we have $\theta = \frac{3\lambda}{d}$

The path difference between the first and the last slit in the grating is an integral number of wavelengths. Let us increase θ so that an extra path difference of λ is introduced across the width w . The change in θ required to do this is denoted by $\Delta\theta$.

$$\Delta\theta = \frac{\lambda}{w}$$

Because of the 360° extra phase across the grating, we can again divide it into two halves so that there is a 180° phase difference between slits separated by $w/2$. So, we get zero intensity at

$$\Delta\theta = \frac{\lambda}{w} = \frac{4 \times 10^{-7}}{10^{-2}} \text{ rad} = 4 \times 10^{-5} \text{ rad} = 2.3 \times 10^{-3} \text{ degrees for violet light}$$

The maximum is sufficiently sharp

Optics - 34) Interference with equations

Two coherent waves are described by the expressions.

$$E_1 = E_{0\sin}\left(\frac{2\pi x_1}{\lambda} - 2\pi ft + \frac{\pi}{6}\right) ; \quad E_2 = E_{0\sin}\left(\frac{2\pi x_2}{\lambda} - 2\pi ft + \frac{\pi}{8}\right)$$

Determine the relationship between x_1 and x_2 that produces constructive interference when the two waves are superposed?

Sol. In interference, $E_r = E_1 + E_2$ (by superposition principle)

$$\phi_1 = \frac{2\pi x_1}{\lambda} - 2\pi ft + \frac{\pi}{6} \quad ; \quad \phi_2 = \frac{2\pi x_2}{\lambda} - 2\pi ft + \frac{\pi}{8}$$

$$\text{Phase difference at } t=0, \quad \Delta\phi = \left(\frac{2\pi x_1}{\lambda} + \frac{\pi}{6}\right) - \left(\frac{2\pi x_2}{\lambda} + \frac{\pi}{8}\right)$$

$$\text{For constructive interference, } \Delta\phi = \pm 2n\pi \quad (\text{where } n = 0, 1, 2, 3, \dots)$$

$$\Rightarrow \pm 2n\pi = \frac{2\pi}{\lambda}(x_1 - x_2) + \frac{\pi}{24} \Rightarrow \pm \left(n - \frac{1}{48}\right)\lambda = (x_1 - x_2)$$

$$\text{[Ans. } \left(n - \frac{1}{48}\right)\lambda = x_1 - x_2]$$

Optics - 35) f number of a camera

Focal number of the lens of a camera is $5f$ and that of another is $2.5f$. The time of exposure for the second

is..... if that for the first is $\frac{1}{200} s$

$$\left(\text{Given } f = \frac{\text{focal length}}{\text{aperature}} \right)$$

(a) $\frac{1}{200} s$

(b) $\frac{1}{800} s$

(c) $\frac{1}{3200} s$

(d) $\frac{1}{6400} s$

[BHU 2005]

Solution (b) f number decreases by 2 \therefore time of exposure should decrease by (2^2) .

$$\therefore t_{\text{new}} = \frac{1}{4} \times \frac{1}{200} = \frac{1}{800} s.$$

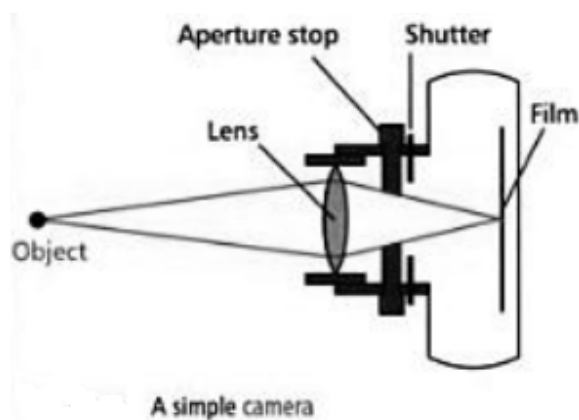

Newton 's Law of Cooling by Prof. Subhashish Chattopadhyay SKMClasses Bangalore Useful for IIT-JEE, CBSE, I.Sc. PU-II, Boards, CET, CEE, PET, IGCSE IB AP-Physics and other exams

If n_1 and n_2 are f-numbers of two cameras and t_1 and t_2 are the exposure times then $(t_1 / t_2) = (n_1 / n_2)^2$

The f-number of a camera lens is defined as $n = f / D$

where D = diameter of the camera lens

and f = focal length

The illumination at the film is proportional to square of diameter of the aperture, and inversely proportional to area of the image. Therefore, if the aperture is circular and of diameter D_a , and the image

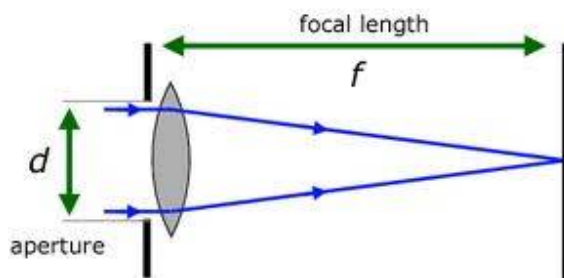

Newton 's Law of Cooling by Prof. Subhashish Chattopadhyay SKMClasses Bangalore Useful for IIT-JEE, CBSE, I.Sc. PU-II, Boards, CET, CEE, PET, IGCSE IB AP-Physics and other exams

is a disc of diameter D_i , then the illumination I_f on the film is,

$$I_f \propto \frac{\text{area of aperture}}{\text{area of image}} \\ \propto (D_a/D_i)^2$$

Since the image size is directly proportional to focal length f ,

$$I_f \propto (D_a/f)^2 \\ \propto 1/N^2$$

Thus, smaller the f -number N the greater is the brightness of the image, and, hence, the smaller is the exposure time (or higher is the shutter speed). The maximum diameter of the aperture is equal to the diameter of the lens. Thus the minimum possible value of N is,

$$N_{\min} = \frac{\text{focal length of the lens}}{\text{diameter of the lens}}$$

This value of N is, therefore, called the f -number (or the speed or the fastness) of the lens. The lenses are usually specified as : 50 mm $f/1.4$, 135 mm $f/3.5$, 85-210 mm $f/4.5$, etc. It is easier to get small f -number in amateur cameras. In these cameras the lens focal length and diameter are small. Therefore, high quality optical blank needed to fabricate a lens is of smaller size and thus less expensive.

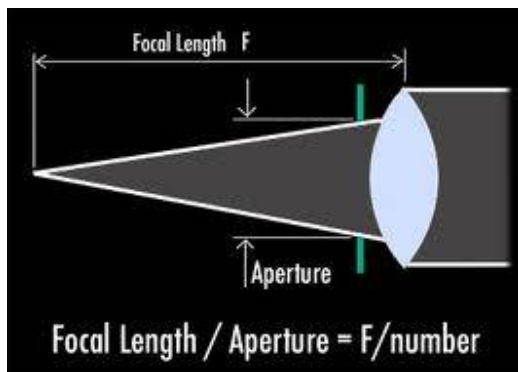
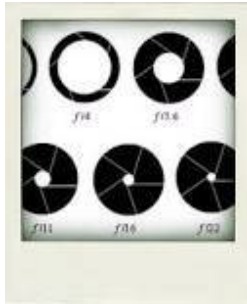

As $I_f \propto 1/N^2$, in most cameras several choices of N are available which change I_f by a factor of two at each step. The corresponding f -numbers then form a geometrical series with a ratio of $\sqrt{2}$, e.g., 1.4, 2, 2.8, 4, 5.6, 8, 11, 16, 22. It starts with the minimum N , the f -number of the lens. For example, if $f = 50$ mm and lens diameter is 36 mm, the starting f -number is 1.4. As the smaller the f -number the higher is the shutter speed, *the lens having smaller starting f -number will be faster.*

An aperture stop is a feature of a good camera. It can be adjusted to allow more or less light through onto the film. For high-speed photography, the shutter is opened for a very short time only, so the aperture needs to be wide open to let as much light through in that short time. Otherwise the image will be too faint. For a given shutter speed, the *f*-number setting controls the amount of light reaching the film. The *f*-number setting determines the area of the aperture on a scale such that the width of the aperture equals the focal length/the *f*-number. To widen the aperture, the *f*-number should therefore be decreased. For example, if the aperture setting on a camera is changed from *f*/4 to *f*/8, this means the aperture is narrowed from one-quarter to one-eighth of the focal length.

The practical scale of *f*-numbers on most cameras is given below. The reason for this scale is that the area of the aperture (which is proportional to the square of the width) is either approximately doubled or halved when the *f*-number is changed from one setting to the next.

<i>f</i> -number	2	2.8	4	5.6	8	11	16	22	32
Aperture width	<i>f</i> /2	<i>f</i> /2.8	<i>f</i> /4	<i>f</i> /5.6	<i>f</i> /8	<i>f</i> /11	<i>f</i> /16	<i>f</i> /22	<i>f</i> /32
Aperture area (relative)	$\frac{1}{4}$	$\frac{1}{7.5}$	$\frac{1}{16}$	$\frac{1}{31.4}$	$\frac{1}{64}$	$\frac{1}{121}$	$\frac{1}{256}$	$\frac{1}{484}$	$\frac{1}{1024}$

The depth of field is affected by the aperture width. When an object is photographed, other objects in view will also be on the same photograph.

The **depth of field** is the range of object distances which give a sharp image on a film at a fixed distance from the lens.

The **depth of focus** is the range of image distances which give a sharp image on a film of an object at fixed distance from the lens.

Newton 's Law of Cooling by Prof. Subhashish Chattopadhyay SKMClasses Bangalore Useful for IIT-JEE, CBSE, I.Sc. PU-II, Boards, CET, CEE, PET, IGCSE IB AP-Physics and other exams

$$f\text{-number} = \frac{f}{D}$$

A larger aperture (a larger value of D) lets more light reach the CCD and gives a smaller f -number. A large f -number (small D) allows less light to get to the CCD. To have a properly exposed photograph (not too bright and not too dark), the total light energy must lie within a certain range. If you reduce the shutter speed and thus keep the shutter open longer, you must compensate by using a smaller aperture and hence a larger f -number.

CONCEPT CHECK

Aperture and Shutter Speed for a Camera

A photographer is taking photos using an f -number of 4 and a shutter speed setting that keeps the aperture open for $1/100 = 0.010$ s. The photographer then changes the f -number to 16. How long should the shutter now be open so as to have the same amount of light energy reach the detector, (a) the same amount of time, (b) 0.0025 s, (c) 0.04 s, or (d) 0.16 s?

-
Modern Physics 1) Spallation reactions (MP-PET-2002 Madhya Pradesh Pre Engineering Test)

See <http://skmclasses.weebly.com/spallation-reaction.html>

-
Modern Physics 2) Ruby LASER (asked in COMED-K Karnataka)

See <http://skmclasses.weebly.com/ruby-laser.html>

-
Modern Physics 3) Various details in Particle Physics (asked in several state exams, including Karnataka CET and COMED-K)

See <http://skmclasses.weebly.com/particle-physics.html>

-
Modern Physics 4) "Magic Numbers" and "Doubly Magic Numbers" in Nuclear Isotope Stability

See <http://skmclasses.weebly.com/magic-number-doubly-magic-in-nucleus.html>

-
Modern Physics 5) Every Alpha (α) decay produces an isodiapher. Meaning isodiaphers are extremely common. There was AIEEE question on isodiaphers. Also asked in many other

Newton 's Law of Cooling by Prof. Subhashish Chattopadhyay SKMClasses Bangalore Useful for IIT-JEE, CBSE, I.Sc. PU-II, Boards, CET, CEE, PET, IGCSE IB AP-Physics and other exams

Newton 's Law of Cooling by Prof. Subhashish Chattopadhyay SKMClasses Bangalore Useful for IIT-JEE, CBSE, I.Sc. PU-II, Boards, CET, CEE, PET, IGCSE IB AP-Physics and other exams

exams. Even though every book talks of α , β , and γ decay; most do not talk about isodiaphers, and positron decay. I find this very strange or rather weird !

In nuclear physics, **isodiaphers** refers to nuclides which have different atomic numbers and mass numbers but the same neutron excess, which is the difference between numbers of neutrons and protons in the nucleus. For example, for both ${}_{90}^{234}\text{Th}$ and ${}_{92}^{238}\text{U}$ the difference between the neutron number (N) and proton number (Z) is $N - Z = 54$.

One large family of isodiaphers has zero neutron excess, $N = Z$. It contains many primordial isotopes of elements up to calcium. It includes ubiquitous ${}_{6}^{12}\text{C}$, ${}_{8}^{16}\text{O}$, and ${}_{7}^{14}\text{N}$.

The daughter nuclide of an alpha decay is an isodiapher of the original nucleus. Similarly, beta decays (and other weak-force-involving decays) produce isobars.

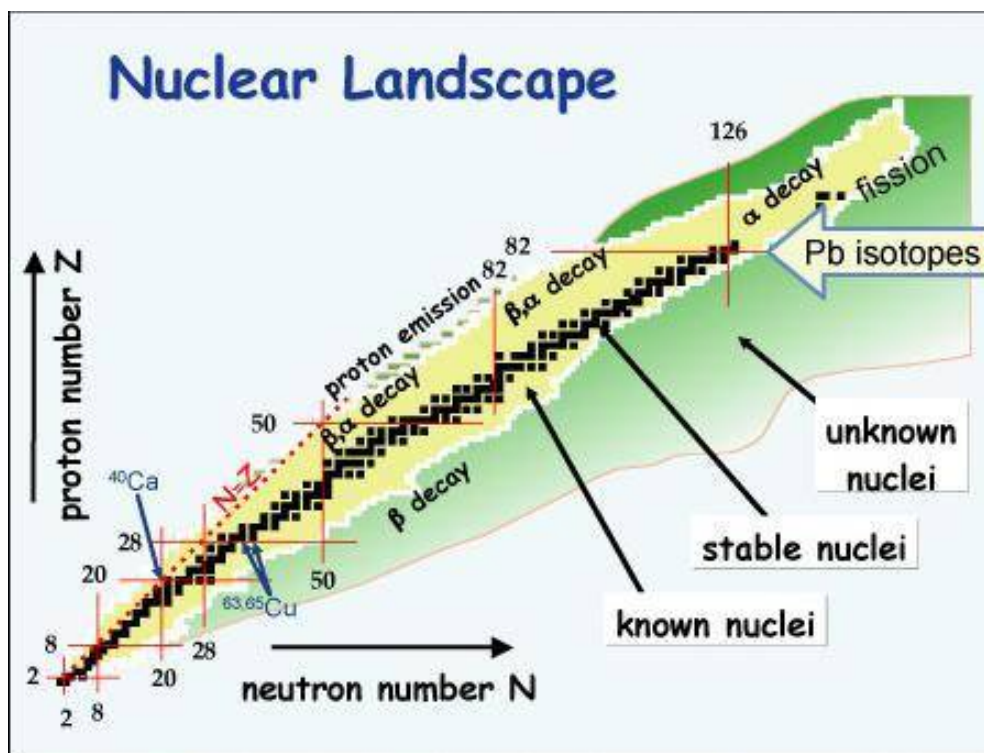

An example of positron emission (β^+ decay) is shown with Magnesium 23 decaying into Sodium 23

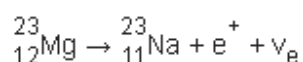

Newton 's Law of Cooling by Prof. Subhashish Chattopadhyay SKMClasses Bangalore Useful for IIT-JEE, CBSE, I.Sc. PU-II, Boards, CET, CEE, PET, IGCSE IB AP-Physics and other exams

Newton 's Law of Cooling by Prof. Subhashish Chattopadhyay SKMClasses Bangalore Useful for IIT-JEE, CBSE, I.Sc. PU-II, Boards, CET, CEE, PET, IGCSE IB AP-Physics and other exams

With a positron emission a Proton changes to Neutron. So Mass number remains the same. In 1934 Frederic and Irene Joliot Curie bombarded aluminium with alpha particles to effect the

nuclear reaction ${}^4_2\text{He} + {}^{27}_{13}\text{Al} \rightarrow {}^{30}_{15}\text{P} + {}^1_0\text{n}$, and observed that the product isotope ${}^{30}_{15}\text{P}$ emits a positron identical to those found in cosmic rays by Carl David Anderson in 1932. Meaning it is surely not so new or modern phenomena that " Modern Physics " chapter of Modern Books are not covering this ! 3 year back a IIT JEE question with Positron is also not changing the taboo !

Once again I will say " So strange is this World ! "

Modern Physics 6) Relativistic correction for mass when electrons are flying at very high speed due to very high voltage.

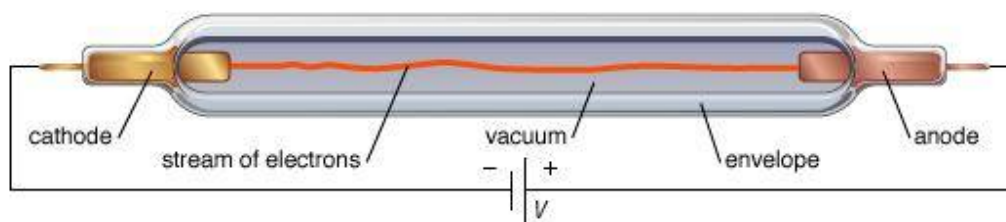

If the voltage is 10KV then what will be the speed of the electrons ?

We know Charge X Voltage = Energy = $\frac{1}{2} mv^2$

Well so far so good. Substitute the values

Charge of electron $e = 1.6 \times 10^{-19}$ Coulomb and mass of electron $m = 9.1 \times 10^{-31}$ kg or 0.511 MeV For sake of this discussion let us approximate electron mass as $0.5 \text{ MeV}/c^2$

So $e (10^4)V = 10^4 \text{ eV} = \frac{1}{2} mv^2 = (\frac{1}{2})(\frac{1}{2} \text{ MeV})(v/c)^2 = (\text{MeV}/4) (v/c)^2$

$4 \times 10^4 = 10^6 (v/c)^2 \Rightarrow 4/100 = (v/c)^2 \Rightarrow v/c = 1/5 \Rightarrow v = c/5$

Upto speed of around $c/5$ we do not take relativistic corrections.

Now what would be the speed of the electrons if the voltage was 1MV ?

A wrong calculation and thus wrong answer would be

X $e (10^6) V = \frac{1}{2} mv^2 = (\frac{1}{2})(\frac{1}{2} \text{ MeV})(v/c)^2 = (\text{MeV}/4) (v/c)^2$

X $4 = (v/c)^2$

X $v/c = 2 \Rightarrow v = 2c$

Students should know that particles can't move at speed more than c

Newton 's Law of Cooling by Prof. Subhashish Chattopadhyay SKMClasses Bangalore Useful for IIT-JEE, CBSE, I.Sc. PU-II, Boards, CET, CEE, PET, IGCSE IB AP-Physics and other exams

An 1 mark question in Karnataka CET had an option close to 98% of c. Student can guess this and tick. While the calculation will be as follows

$$\text{Let } k = \sqrt{1 - \frac{v^2}{c^2}}$$

$$\text{We will have } e (10^6) V = \frac{1}{2} (m/k)v^2 = (\frac{1}{2})(\frac{1}{2} \text{ MeV}/k)(v/c)^2 = (\text{MeV}/4k) (v/c)^2$$

$$\text{So } 4k = (v/c)^2 \quad \text{put } v/c = x \quad \text{we get } 4\sqrt{1 - x^2} = x^2 \quad \text{put } x^2 = y \quad \text{so } 4\sqrt{1 - y} = y$$

$$\text{Or } 16(1 - y) = y^2 \Rightarrow y^2 + 16y - 16 = 0 \quad \text{Solve the quadratic to get } y = 0.95$$

$$\text{So } x^2 = 0.95 \text{ or } x = \sqrt{0.95} = 0.975 \Rightarrow v/c = 0.975 \quad \text{or } v = 97.5\% \text{ of light speed}$$

Electronics 1)

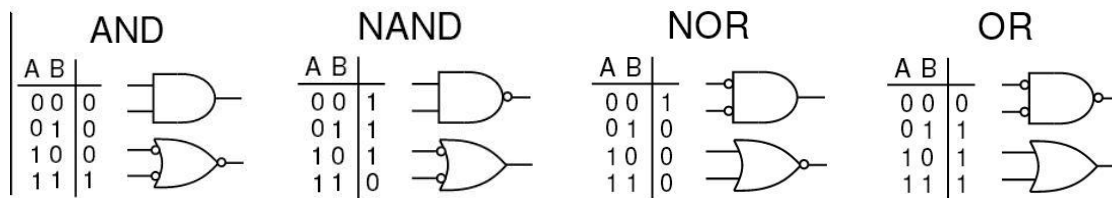

The small circle (bubble) at the output of the graphic symbol of a NOT gate is formally called a negation indicator and designates the logical complement.

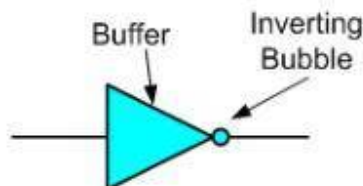

NOT gate can be implemented by NOR Gate. All the pins have to be connected to same signal.

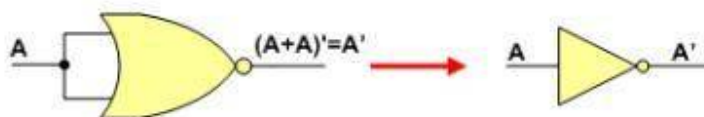

Similarly NOT gate can be implemented with NAND gates

All NAND input pins connect to the input signal **A** gives an output **A'**.



XOR (exclusive OR) gate can be implemented with other gates. In various exams the connections are asked.

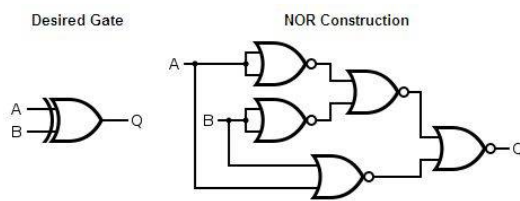

Truth Table

Input A	Input B	Output Q
0	0	0
0	1	1
1	0	1
1	1	0

Exclusive-OR equivalent circuit

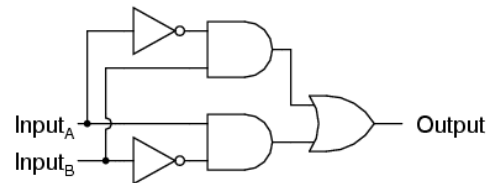

A	B	Output
0	0	0
0	1	1
1	0	1
1	1	0

Exclusive OR (XOR)

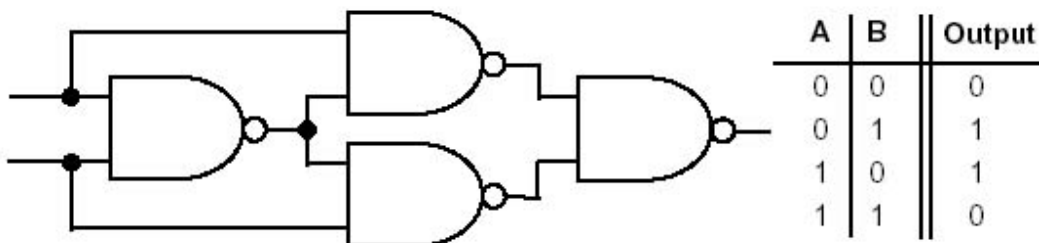

To design the logic circuits the following laws of Boolean algebra are commonly used: commutativity, associativity, distributivity, and De Morgan's laws. Note that distributivity of disjunction over conjunction and both De Morgan's laws do not have their counterparts in ordinary algebra of real numbers.

Property	For conjunction	For disjunction
Commutativity	$A \cdot B = B \cdot A$	$A + B = B + A$
Associativity	$A \cdot (B \cdot C) = (A \cdot B) \cdot C$	$A + (B + C) = (A + B) + C$
Distributivity	$A \cdot (B + C) = A \cdot B + A \cdot C$	$A + B \cdot C = (A + B) \cdot (A + C)$
De Morgan's laws	$\overline{A \cdot B \cdot \dots} = \overline{A} + \overline{B} + \dots$	$\overline{A + B + \dots} = \overline{A} \cdot \overline{B} \cdot \dots$
Basic identities	$A \cdot 0 = 0$ $A \cdot 1 = A$ $A \cdot A = A$ $A \cdot \overline{A} = 0$	$A + 1 = 1$ $A + 0 = A$ $A + \overline{A} = 1$ $A + A = A$
Additional identities	$A \cdot (\overline{A} + B) = A \cdot B$ $A + \overline{A} \cdot B = A + B$ $(A + B) \cdot (\overline{A} + \overline{B}) = \overline{A \cdot B}$	$A + A \cdot B = A + B$ $A \cdot (\overline{A} + B) = A \cdot B$ $A \cdot B + \overline{A} \cdot B = B$

Principal identities and laws of Boolean algebra.

Implementing OR Gate with NAND gates

An OR gate can be replaced by NAND gates as shown in the figure (The OR gate is replaced by a NAND gate with all its inputs complemented by NAND gate inverters).

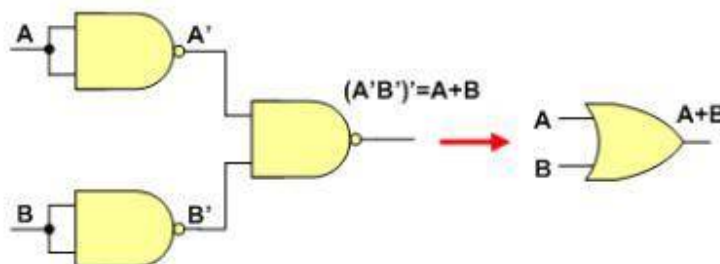

Implementing AND gate with NOR gates

An AND gate can be replaced by NOR gates as shown in the figure (The AND gate is replaced by a NOR gate with all its inputs complemented by NOR gate inverters).

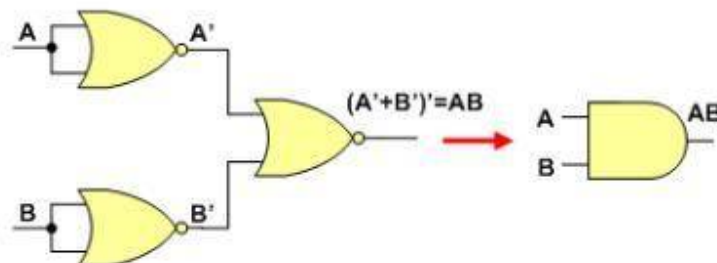

Colour Code for Carbon Resistors

Since a carbon resistor is physically quite small, it is more convenient to use a *colour code* indicating the resistance value than to imprint the numerical value on the case. In this scheme, there are generally four colour bands *A*, *B*, *C* and *D* printed on the body of the resistor as shown in Fig. The first three colour bands (*A*, *B* and *C*) give the value of the resistance while the fourth



band (*D*) tells about the *tolerance in percentage. The table below shows the colour code for resistance values and colour code for tolerance.

Colour Code for Resistance Values

Black	0	Green	5
Brown	1	Blue	6
Red	2	Violet	7
Orange	3	Grey	8
Yellow	4	White	9

Colour Code for Tolerance

Gold	$\pm 5\%$
Silver	$\pm 10\%$
No colour	$\pm 20\%$

- (i) To read the resistance value, we refer to the first three colour bands (*A*, *B* and *C*). The first two colour bands (*A*, *B*) specify the first two digits of the resistance value and the third colour band (*C*) gives the number of zeros that follow the first two digits. Suppose the first three colour bands (*A*, *B*, *C*) on the resistor are red, brown, orange respectively. Then value of the resistance is 21,000 Ω .

Red : 2

Brown : 1

Orange : 000

\therefore Value = 21,000 Ω

(ii) The fourth band *D* gives the value of tolerance in percentage. If colour of the fourth band is gold, tolerance is ± 5 per cent and if silver, then tolerance is ± 10 per cent. If the fourth band is omitted, the tolerance is assumed to be ± 20 per cent.

0 B ↓ Black	1 B ↓ Brown	2 R ↓ Red	3 O ↓ Orange	4 Y ↓ Yellow	5 G ↓ Green	6 B ↓ Blue	7 V ↓ Violet	8 G ↓ Grey	9 W ↓ White
----------------------	----------------------	--------------------	-----------------------	-----------------------	----------------------	---------------------	-----------------------	---------------------	----------------------

Note. In order to remember the colour code, the above sentence may be helpful.

Example The colour coded carbon resistors are shown in Fig. Find their resistance values.

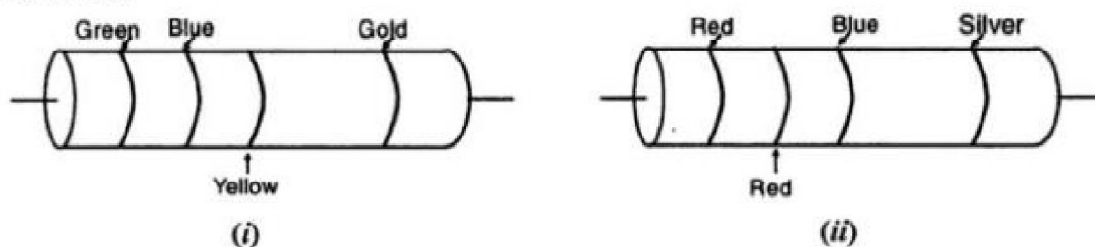

Solution. The first colour represents the digit 5. The second colour represents the digit 6. The third colour represents the digit 4, *i.e.*, four zeros. Therefore, the value of the resistance is 56,0000 Ω . The fourth gold strip indicates $\pm 5\%$ tolerance. Hence, resistance specification of the resistor is

$$560000 \Omega ; \pm 5\%$$

(ii) Refer to Fig. resistor is

Following above procedure, the resistance specification of this

$$22,000000 \Omega ; \pm 10\%$$

- * Due to manufacturing variations, the resistance value may not be the same as indicated by colour code. Thus, a resistor marked 100 Ω , $\pm 10\%$ tolerance means that resistance value is between 90 Ω and 110 Ω .

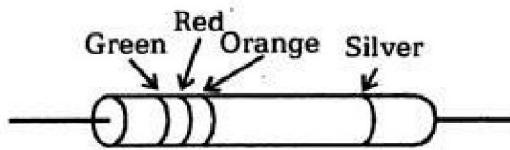

"Carbon resistor colour code"

The value of the above resistor as shown in the fig. is

The first ring Green - 5

The second ring Red - 2

The third ring Orange ring corresponds to - 10^3

The silver ring represents 10% tolerance

∴ Total resistance is

$52 \times 10^3 \pm 10\%$ (or) $52\text{k}\Omega, 10\%$

Varactor diode

$\text{—} \triangleright \text{—}$ is the symbol of

- (a) a capacitor (b) photo diode
(c) varactor diode (d) tunnel diode

Ans: (c)

Common emitter

In a common emitter configuration the base - emitter voltage is 3×10^{-2} V. If the base current is $30 \mu\text{A}$, the input impedance is

- (a) $1 \text{ k}\Omega$ (b) $3 \text{ k}\Omega$
(c) 100Ω (d) $2 \text{ k}\Omega$

Ans: (a)

Solution:

Given data:-

$$(V_{BE}) = \text{Base emitter voltage} = 3 \times 10^{-2} \text{V}$$

$$\text{Base current } (I_B) = 30 \times 10^{-6} \text{ A}$$

$$\text{Input impedance } Z_i = \left(\frac{\Delta V_{BE}}{\Delta I_B} \right)_{V_{CE}}$$

$$Z_i = \frac{3 \times 10^{-2}}{30 \times 10^{-6}}$$

$$Z_i = Z_i = \frac{3 \times 10^{-2}}{10 \times 10^{-6}} = 10^{-2-1+6}$$

$$Z_i = 10^3 \Omega$$

$$Z_i = 1 \text{ k}\Omega$$

Common base

In a common base configuration, the collector current is 0.95 mA and base current is 0.05 mA , then the value of current gain is

- (a) 0.89 (b) 0.9
(c) 0.95 (d) 0.99

Ans: (c)

Given data:-

$$\text{Collector current } I_C = 0.95 \times 10^{-3} \text{A}$$

$$\text{Base current } I_B = 0.05 \text{ mA} = 0.05 \times 10^{-3} \text{A}$$

Solution:

$$\text{Current gain } \alpha = \left(\frac{I_C}{I_E} \right)$$

$$I_E = \text{Emitter current} = I_C + I_B$$

$$= (0.95 + 0.05) \times 10^{-3} \text{ A}$$

$$= 1 \times 10^{-3} \text{ A} = 1 \text{ mA}$$

$$\alpha = \frac{0.95 \times 10^{-3} \text{ A}}{1 \times 10^{-3} \text{ A}} = 0.95$$

The current gain is 0.95

Common emitter

In a common emitter amplifier, the output resistance is 5000Ω and the input resistance is 2000Ω . If the peak value of the signal voltage is 10 mV and $\beta = 50$, then the peak value of the output voltage is

- (a) $5 \times 10^{-6} \text{ V}$ (b) 1.25 V
(c) 125 V (d) $2.5 \times 10^{-4} \text{ V}$

Ans: (b)

Given data:-

$$R_L = 5000 \Omega$$

$$R_i = 2000 \Omega$$

$$\beta = 50$$

Solution:

The ac voltage gain is given by

$$\beta \times \frac{R_L}{R_i} = \frac{50 \times 5000}{2000} = 125$$

\therefore peak output voltage $\hat{=} \text{voltage gain} \times \text{signal voltage}$

$$= 125 \times 10 \text{ mV} = 1250 \text{ mV} = 1.25 \text{ V}$$

Common base

In a common base amplifier circuit, calculate the change in base current if that in the collector current is 2 mA and $\alpha = 0.98$

- (a) 0.04 mA (b) 1.96 mA
(c) 980 mA (d) 2 mA

Ans: (a)

Solution:

$$\beta = \frac{\alpha}{1 - \alpha} = \frac{0.98}{1 - 0.98} = 49$$

$$\text{Now } \Delta I_c / \Delta I_b = 49$$

$$\text{or } \Delta I_b = \Delta I_c / 49$$

$$\therefore \Delta I_b = 2 \text{ mA} / 49 \\ = 0.04 \text{ mA}$$

Common base

In a common base circuit of a transistor, current amplification factor is 0.95. Calculate the base current when emitter current is 2 mA.

- (a) 0.1 mA (b) 1 mA
(c) 0.01 mA (d) none of these

Ans: (a)

Solution:

$$\alpha = \frac{I_C}{I_E}$$

$$0.95 = \frac{I_C}{2 \times 10^{-3}}$$

$$I_C = 1.90 \times 10^{-3} \text{ A} = 1.9 \text{ mA}$$

$$\text{Now } I_B = I_E - I_C = 0.1 \text{ mA}$$

Common emitter

A transistor is connected in common emitter (CE) configuration. The collector supply is 8V and the voltage drop across a resistor of 800Ω in the collector circuit is 0.5V. If the current gain factor (α) is 0.96. Find the base current.

- (a) 20 μA (b) 26 μA
(c) 30 μA (d) none of these

Ans: (b)

Solution:

$$\text{Collector current } I_C = \frac{0.5}{800} \text{ A}$$

$$\text{Current gain } \beta = \frac{I_C}{I_B}$$

$$\frac{\alpha}{1 - \alpha} = \frac{0.96}{800} \text{ A}$$

$$I_B = \frac{I_C}{24} = \frac{0.5}{800 \times 24} \\ = 26 \mu\text{A}$$

Conductivity

Conductivity is defined as the current density per unit applied electric field. If J is the current density due to an applied electric field E , then the conductivity (σ) is given by,

$$\sigma = \frac{J}{E} \quad \text{.....(1)}$$

In S.I., σ is given in Siemens/meter or mho/meter as 1 siemen = 1 mho

For a cylindrical semiconductor, the current density is given by,

$$J = ne v \quad \text{.....(2)}$$

where n is the number of charge carriers in the semiconductor e is the electronic charge and v is the drift velocity of the electron.

Also, we have $v = \mu E$ (3)

where μ is the mobility of the charge carrier and E is the applied electric field.

Then, equation (2) can be written,

$$J = ne \mu E$$

then, equation (1) becomes,

$$\sigma = ne \mu \quad \text{.....(4)}$$

Now, if the conductivity of a semiconductor is due to electron then it is denoted by σ_n , and equation (4), can be written as

$$\sigma_n = ne \mu_n \quad \text{.....(5)}$$

where n is the number of electron and μ_n is the mobility of electron.

Similarly, the conductivity of a semiconductor due to the holes is given by,

$$\sigma_p = pe \mu_p \quad \text{.....(6)}$$

where p is the hole concentration and μ_p is the hole mobility.

Hence, the overall conductivity of the semiconductor containing electrons and holes is given by,

$$\sigma = \sigma_n + \sigma_p = e (n \mu_n + p \mu_p) \quad \text{.....(7)}$$

For an intrinsic semiconductor, $n = p = n_i$

Therefore, the conductivity of an intrinsic semiconductor,

$$\sigma_{int} = n_i e (\mu_n + \mu_p) \quad \text{.....(8)}$$

For an n -type semiconductor, $n \gg p$, then

$$\sigma_n \approx ne \mu_n \quad \text{.....(9)}$$

Similarly, for a p -type semiconductor

$$\sigma_p = pe \mu_p \quad \text{.....(10)}$$

These equations shows that conductivity σ has the same temperature dependence as μ_e or μ_n .

Mobility is a more useful property for characterizing a semiconductor than conductivity. Conductivity, σ depends on carrier concentration *i.e.*, on doping level but mobility μ does not depend. Thus, mobility is the property of semiconductor itself.

Problem 1 : At 300 K, the intrinsic carrier concentration of silicon is $1.5 \times 10^{16} \text{ m}^{-3}$. If the electron and the hole mobilities are 0.13 and 0.05 $\text{m}^2/\text{sec-V}$ respectively. Determine the conductivity and resistivity of silicon.

Solution : The electrical conductivity of intrinsic semiconductor is given by,

$$\sigma_i = n_i e (\mu_n + \mu_p)$$

Here, $n_i = 1.5 \times 10^{16} \text{ m}^{-3}$, $\mu_n = 0.13 \text{ m}^2/\text{sec-V}$, $\mu_p = 0.05 \text{ m}^2/\text{sec-V}$ and $e = 1.6 \times 10^{-19} \text{ Coulomb}$

$$\begin{aligned} \therefore \sigma_i &= 1.5 \times 10^{16} \times 1.6 \times 10^{-19} \times (0.13 + 0.05) \\ &= 2.4 \times 10^{-3} \times 0.18 = 0.432 \times 10^{-3} \\ &= 4.32 \times 10^{-4} \text{ mho/m} \end{aligned}$$

Hence, the resistivity ρ_i is given by

$$\rho_i = \frac{1}{\sigma_i} = \frac{1}{4.32 \times 10^{-4}} = 2.31 \times 10^3 \text{ ohm-m}$$

Problem 2 : The resistivity of pure silicon at room temperature is 3000 ohm-m. Calculate the intrinsic carrier concentration. Given that : $\mu_n = 0.14 \text{ m}^2/\text{sec-V}$ and $\mu_p = 0.05 \text{ m}^2/\text{sec-V}$.

Solution : In pure silicon, electrons and holes (the intrinsic charge carriers) are equal in numbers. The conductivity of pure semiconductor is given by

$$\sigma = n_i e (\mu_n + \mu_p) \quad \text{or} \quad n_i = \frac{\sigma}{e(\mu_n + \mu_p)} = \frac{1}{\rho e (\mu_n + \mu_p)} \quad \left[\because \rho = \frac{1}{\sigma} \right]$$

$$\therefore n_i = \frac{1}{(0.14 + 0.05) \times 3000 \times 1.602 \times 10^{-19}} = 1.095 \times 10^{16} \text{ m}^{-3}$$

The band gap of a specimen of gallium arsenide phosphide is 1.98 eV. Determine the wavelength of the radiation that is emitted when electron jumps from conduction band to the valence band to recombine with a hole.

Solution : The wavelength of emitted radiation is given by,

$$\lambda = \frac{hc}{E_g}$$

Here, h = Planck's constant = $6.62 \times 10^{-34} \text{ J.s}$, c = velocity of light = $3 \times 10^8 \text{ m/s}$ and

$$E_g = \text{Energy band gap} = 1.98 \text{ eV} = 1.98 \times 1.6 \times 10^{-19} \text{ J.}$$

$$\begin{aligned} \therefore \lambda &= \frac{6.62 \times 10^{-34} \times 3 \times 10^8}{1.98 \times 1.6 \times 10^{-19}} = 6.269 \times 10^{-7} \text{ m} \\ &= 6269 \text{ \AA} \end{aligned}$$

Since this wave-length is in the visible range, so the colour of the emitted radiation will be red.

Q. An n-type semiconductor crystal has more free electrons than holes. Is it then negatively charged ?

Ans : An n-type semiconductor has free electrons as charge carriers. These are donated by pentavalent impurity atoms which becomes positively charged. Although there are some thermally generated electron-hole pairs, but the number of these holes is negligibly small in comparison to the total number of electrons. Thus, n-type semiconductor mainly consists of negatively charged free electrons and nearly equal number of positively charged donor ions. Hence, the material as a whole is electrically neutral.

Q. *p*-type semiconductor crystal has more holes than electrons. Is it then positively charged ?

Ans : A *p*-type semiconductor has holes as charge carriers. These holes are due to trivalent impurity atoms which become negatively charged by accepting the electrons from the neighbouring Ge atom. Although there are some thermally generated electron-hole pairs, but the number of these electrons is negligibly small in comparison to the total number of holes. Thus, *p*-type semiconductor mainly consists of positively charged holes and nearly equal number of negatively charged acceptor ions. Hence, the material as a whole is electrically neutral.

Q. Why does the width of depletion region increase when a *p-n* junction is reverse biased ?

Ans : In reverse bias, negative terminal of the battery is connected to *p*-side and positive terminal to *n*-side of *p-n* junction. So, the electrons are attracted towards positive terminal and holes towards negative terminal of the battery. Thus, holes and free electrons move away from the junction. Therefore, the depletion layer gets wider. The width of the layer increases with increasing reverse voltage.

Q. The small current flowing through a reverse biased junction diode is called the reverse saturation current, why ?

Ans : The reverse current is due to the thermally generated minority carriers. We cannot increase the number of these minority carriers by applying and increasing the reverse voltage. So, it is termed as saturation current. This current flows in the opposite direction with respect to forward bias, so it is called reverse. Due to above both factors it is called reverse saturation current.

Q. The reverse saturation current of a Si diode is much smaller than a Ge diode of the same size, why ?

Ans : The barrier potential of Si is 0.7 eV while that of Ge is 0.3 V. Hence, less number of thermally generated minority carriers cross the junction in Si diode than that in Ge diode of the same size. Therefore, the reverse current in Si diode is smaller than the Ge diode at the same temperature and for the same size.

Q. Differentiate between Avalanche and Zener breakdown.

Ans : **Avalanche breakdown :** For a simple *p-n* junction, if we apply a reverse bias to the junction, a very small current due to minority carriers flows through the junction. On increasing the reverse voltage the minority carriers (electrons) may attain sufficient kinetic energy to knock out valency electron from the covalent bonds. As a result more electron-hole pairs are generated. Due to the high reverse bias voltage, these new carriers are also accelerated and collide with other covalent bonds. This process will continue until an avalanche of electrons is formed and a very large current flows through the junction diode. This breakdown is known as Avalanche breakdown. This breakdown occurs at very high voltage.

Zener breakdown : If the *p-n* junction is heavily doped then the electric field across the depletion layer becomes large enough. When we apply a reverse bias to this junction then this electric field becomes so large even at low voltage that it may cause rupture of the covalent bonds and breakdown the junction. This breakdown is known as Zener breakdown and this diode is known as Zener diode. This breakdown occurs at lower voltage than avalanche breakdown.

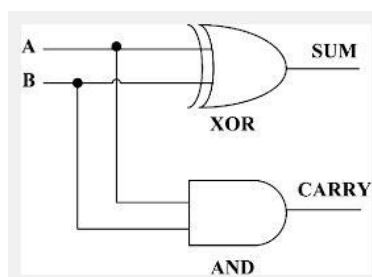

Half Adder

Q. : What is mass-action law for the carrier concentrations in a semiconductor ? What is its significance ?

Ans : The law of mass-action states that in any type of semiconductor (p or n type), the product of free electrons concentration, n and hole concentration, p is a constant and equal to n_i^2 where n_i is the intrinsic carrier concentration *i.e.*,

$$np = n_i^2$$

The intrinsic carrier concentration n_i is a function of temperature. At a given temperature if electron concentration is increased by doping, the corresponding hole concentration (p) must decrease (or vice-versa) to keep np a constant ($= n_i^2$) at a particular temperature.

Q. : Explain why an extrinsic semiconductor at high temperature behaves like an intrinsic one.

Ans : At very high temperature, the concentration of thermally generated free electrons from the valence band becomes much larger than concentration of free electrons contributed by donors (as donor atoms are already ionized). In this condition, the hole and electron concentrations will be nearly equal and semiconductor will behave like an intrinsic one. Due to the same reason p -type semiconductor will also behave like an intrinsic semiconductor at very temperatures. So, we can say that an extrinsic semiconductor changes to an intrinsic one at very high temperatures.

Q. : What do you mean by the term "doping" and "dopant" . Name some dopant materials ?

Ans : The addition of a small percentage of impurity atoms to a semiconductor is called "doping" and the impurity, which is added, is referred to as "dopant". In Ge or Si, the elements of V group like phosphorous (P) antimony (Sb) and arsenic (As) and the elements of III group like aluminium (Al), Indium (In) boron (B) and gallium (Ga) are dopant.

Q. Write diode equation and with the help of this equation describe the volt-ampere characteristics of the diode.

Ans : The diode equation is written as,

$$I = I_0 (\exp \frac{eV}{kT} - 1) \quad \dots\dots(1)$$

where I is current at applied voltage, V

I_0 is constant and known as reverse saturation current

e is electronic charge

k is Boltzmann constant

and T is absolute temperature

With the help of this equation we can describe the volt ampere characteristics as shown in fig 1.23

If V is positive *i.e.*, for a forward bias

then, $\exp \frac{eV}{kT} \gg 1$

So, equation (1) can be written as,

$$I = I_0 \exp \frac{eV}{kT}$$

Hence, for a forward bias, current increases exponentially as shown in fig. 1.24.

Similarly, if V is negative *i.e.*, for a reverse bias then,

$$\exp^{-\frac{eV}{kT}} \ll 1$$

So, equation (1) can be written as,

$$I = -I_0$$

Hence, for a reverse bias current is constant in reverse direction as shown in fig.

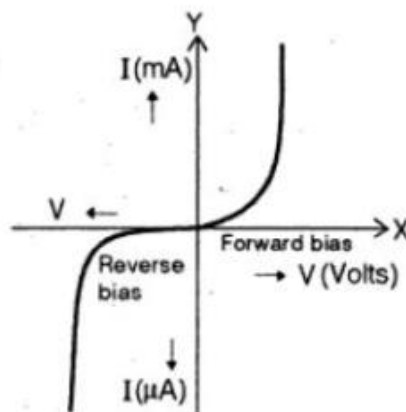

Q. How reverse current depends upon the temperature of the junction ?

Ans : The reverse current in a $p-n$ junction diode depends on the temperature T . The rise in temperature increases the generation of electron hole pairs in semiconductors and increases their conductivity as a result the current through junction diode increases with temperature. For practical diodes it is found that reverse saturation current I_0 will just about double in magnitude for every 10°C increase in temperature. Typical values of I_0 for silicon are much lower than that of Germanium for similar power and current levels. The result is that silicon junction diodes are more preferred than Ge for rectifiers and have higher breakdown voltage.

Q. : What do you mean by tunnel diode ?

Ans : Tunnel diode is very high doped ($\approx 10^{25}/\text{m}^3$) $p-n$ junction in both p and n region. Since, the depletion layer of this diode becomes very thin, so, on applying forward bias many carriers can tunnel through the depletion layer and the process is known as tunnelling. Hence, the diode is known as tunnel diode.

Newton 's Law of Cooling by Prof. Subhashish Chattopadhyay SKMClasses Bangalore Useful for IIT-JEE, CBSE, I.Sc. PU-II, Boards, CET, CEE, PET, IGCSE IB AP-Physics and other exams

Heat or Thermodynamics 1) So many exams including IIT JEE had questions on Polytrropic processes. Apart from Professor N. N. Ghosh's books, hardly this is covered in Physics Books

I am surprised and **amused** to see so many coaching Institutes making errors in Polytrropic Process Problems. In most cases the teachers are avoiding it, and in rare cases when it is being covered there are errors.

Let us do it here.

We assume ideal gas for Thermodynamics process problems. So $PV = nRT$ is taken as true regardless the process gas is taken through. So Isothermal (meaning constant Temperature), Isobaric (meaning const Pressure), Isochoric (meaning constant Volume) or even $PV^z = \text{Const}$ (P into V to the power z is constant) where z is a constant of the polytrropic process, the expression $PV=nRT$ is taken as true. We do substitute that to exchange the variables in many problems.

Work done by system on boundary is:

$$W = \int_{V_1}^{V_2} p \, dV$$

P | ~~can be a polytrropic exp~~

This form is used for expansion and contraction of gases
Ideal Gases

Ideal (Perfect) Gas Law

$$pV = nRT$$

$$R = 8314 \frac{\text{kJ}}{\text{kmol} \cdot \text{K}}$$

If the gas expands (often due to supply of heat) the work done by the gas is taken as positive.

Work done expression in Isothermal (or isotropic as some people say it) is given by

Isothermal (Constant Temp) Process or Isothermal process

- For a constant temperature process in a closed system (i.e. mass is constant) – $pV = mRT = C$. Where C is a constant. Note C can be written as p_1V_1 or as p_2V_2 .

$$\bullet \quad W = \int_{V_1}^{V_2} \frac{C}{V} \, dV = C \ln\left(\frac{V_2}{V_1}\right) = p_1V_1 \ln\left(\frac{V_2}{V_1}\right) = nRT \ln\left(\frac{V_f}{V_i}\right) = nRT \ln\left(\frac{P_i}{P_f}\right)$$

Newton 's Law of Cooling by Prof. Subhashish Chattopadhyay SKMClasses Bangalore Useful for IIT-JEE, CBSE, I.Sc. PU-II, Boards, CET, CEE, PET, IGCSE IB AP-Physics and other exams

Polytropic process - $pV^n=C$ where C is a constant.

these occur in ideal gases for various processes and the value of n changes depending on the type of process (e.g. $n = 1$ is a isotropic process).

Note that $p_1V_1^n=C \rightarrow p_1V_1=\frac{CV_1}{V_1^n}=CV_1^{1-n}$ This also holds for p_2V_2 .

$$W = \int_{V_1}^{V_2} \frac{C}{V^n} dV = \frac{C}{1-n} (V_2^{1-n} - V_1^{1-n}) = \frac{p_2V_2 - p_1V_1}{1-n}$$

In case of adiabatic process (where no heat exchange takes place), n is γ (gamma), so in the above expression replace n as γ

$$pV^\gamma = p_1V_1^\gamma = p_2V_2^\gamma = k$$

Thus,
$$p = \frac{k}{V^\gamma}$$

The work done by the gas in the process is

$$W = \int_{V_1}^{V_2} p dV = \int_{V_1}^{V_2} \frac{k}{V^\gamma} dV = \frac{1}{1-\gamma} \left[\frac{k}{V_2^{\gamma-1}} - \frac{k}{V_1^{\gamma-1}} \right]$$

From equation (i),

$$\frac{k}{V_2^\gamma} = p_2 \text{ and } \frac{k}{V_1^\gamma} = p_1$$

Thus,
$$W = -\frac{1}{\gamma-1} (p_2V_2 - p_1V_1) = \frac{p_1V_1 - p_2V_2}{\gamma-1}$$

There are other expressions which are handy (given for 1 mole of gas), for Heat supplied in Polytropic Process

$$\Delta H = C_P^0(T_2 - T_1) = \frac{\gamma R}{\gamma-1} (T_2 - T_1) = \frac{\gamma}{\gamma-1} (P_2V_2 - P_1V_1) = \frac{\gamma P_1V_1}{\gamma-1} \left[\left(\frac{P_2}{P_1} \right)^{1-\frac{1}{n}} - 1 \right]$$

Heat Supplied in a process at constant Pressure is $\Delta H = C_P^0(T_2 - T_1)$

Process	Work Done: (W)	Heat Exchanged (ΔQ)
Isothermal process	$W = 2303 nRT \log_{10} \frac{V_2}{V_1}$	$\Delta Q = 2.30 nRT \log \frac{V_2}{V_1}$
Adiabatic process	$W = \frac{p_1 V_1 - p_2 V_2}{\gamma - 1}$ $= \frac{nR(T_2 - T_1)}{\gamma - 1}$	$\Delta Q = 0$
Isochoric process	$W = 0$	$\Delta Q = nC_v \Delta T$ (use definition of C_v)
Isobaric process	$W = p\Delta V = p(V_2 - V_1)$ $W = nR(T_2 - T_1)$	$\Delta Q = nC_p \Delta T$ (use definition of C_p)

VdP expression in polytropic process

For a polytropic process $P_1 V_1^n = P V^n$

$$V = \left(\frac{P_1 V_1^n}{P} \right)^{\frac{1}{n}} = \left(\frac{P_1}{P} \right)^{\frac{1}{n}} V_1$$

$$\int V dP = P_1^{\frac{1}{n}} V_1 \int \frac{1}{P^{\frac{1}{n}}} dP$$

$$\int V dP = \frac{P_1^{\frac{1}{n}} V_1}{1 - \frac{1}{n}} \left(P_2^{1 - \frac{1}{n}} - P_1^{1 - \frac{1}{n}} \right)$$

$$\int V dP = \frac{n V_1}{n - 1} \left(P_1^{\frac{1}{n}} P_2^{1 - \frac{1}{n}} - P_1 \right)$$

$$P_2 \int_{P_1}^2 V dP = \frac{n P_1 V_1}{n - 1} \left[\left(\frac{P_2}{P_1} \right)^{1 - \frac{1}{n}} - 1 \right]$$

$$- \int_1^2 V dP = \frac{n P_1 V_1}{n - 1} \left[1 - \left(\frac{P_2}{P_1} \right)^{1 - \frac{1}{n}} \right]$$

Specific heat in case of Polytropic process and C_v in terms of γ

$$C = \frac{R}{\gamma-1} - \frac{R}{k-1}$$
$$C_v = \frac{R}{\gamma-1}$$

Example

One mole of Argon is heated using $PV^{5/3} = \text{const}$. Find the amount of heat obtained by the process when the temperature changes by $\Delta T = -26 \text{ K}$.

Solution

Let p be the number of moles here $p = 1$

$$\text{then } C = \frac{R}{\gamma-1} - \frac{R}{\eta-1} = \frac{R}{\frac{5}{3}-1} - \frac{R}{\frac{3}{2}-1}$$

$$\Delta Q = pC\Delta T = 1 \left(\frac{3}{2}R - 2R \right) (-26)$$

$$= +26 \left(\frac{8.314}{2} \right) = 108 \text{ J}$$

You can also write $+ R / (1-k)$ in Specific heat expression so see an example

An ideal gas expands according to the law $PV^{3/2} =$ constant. We conclude

- (a) The adiabatic exponent of the gas $K = 1.5$
- (b) The molar heat capacity $C = C_v - 2R$
- (c) Temperature increases during the process
- (d) Such a process is not feasible

Ans - (b) Molar heat capacity

$$C = C_v + \frac{R}{1-K} = C_v + \frac{R}{1-\frac{3}{2}} = C_v - 2R$$

IIT JEE 1995 Polytropic Thermodynamics Process Problem

3 moles of a gas mixture having volume V and temperature T is compressed to 1/5th of the initial volume. Find the change in its adiabatic compressibility if the gas obeys $PV^{19/13} = \text{constant}$ [$R = 8.3 \text{ J/mol} - \text{K}$]

[IIT 1995]

$$\text{Bulk modulus } B = \gamma P$$

$$\text{Compressibility } C = \left(\frac{1}{B} \right) = \frac{1}{\gamma P}$$

and $\Delta C = C - C$

or $\Delta C = \frac{1}{\gamma} \left[\frac{1}{P'} - \frac{1}{P} \right]$

$$PV^\gamma = P' \left(\frac{V}{5} \right)^\gamma$$

$$\text{With } \gamma = \frac{19}{13} \text{ and } P' = 5^{\gamma} P, 11$$

$$\Delta C = \frac{1}{\gamma P} \left[\frac{1}{5^{\gamma}} - \frac{1}{1} \right] = \frac{13 \times 0.905}{19P}$$

$$\text{But } PV = nRT \text{ or } P = \frac{nRT}{V}$$

$$\Delta C = \frac{13(.905)V}{19 \times 3 \times 8.317T} = \frac{-0.0248V}{T}$$

An ideal gas with adiabatic exponent γ , is expanded according to the law

$$P = aV$$

where a is a constant. The initial volume of the gas is V_0 . As a result volume increases η times. Find the increment in internal energy and work done.

Solution - Let k be number of moles

$$P = aV \text{ or } PV^{-1} = a$$

The process is polytropic with index $n = -1$

$$\therefore V_{\text{initial}} = V_0, V_{\text{final}} = \eta V_0$$

$$\text{and } P_{\text{initial}} = aV_0; P_{\text{final}} = a\eta V_0$$

$$\Delta U = \frac{kR}{\gamma - 1} (T_{\text{final}} - T_{\text{initial}}), P_{\text{final}} V_{\text{final}} - P_{\text{initial}} V_{\text{initial}}$$

Work done,

$$W = \frac{P_{\text{initial}} V_{\text{initial}} - P_{\text{final}} V_{\text{final}}}{n - 1} = \frac{\alpha V_0^2 [\eta^2 - 1]}{2}$$

In a polytropic process an ideal gas ($\gamma = 1.40$) was compressed from volume $V_1 = 10$ litres to $V_2 = 5$ litres. The pressure increased from $p_1 = 10^5$ Pa to $p_2 = 5 \times 10^5$ Pa. Determine: (a) the polytropic exponent n , (b) the molar heat capacity of the gas for the process.

Solution.

In a polytropic process $pV^n = k$ (a constant)

$$\therefore p_1 V_1^n = p_2 V_2^n \quad \text{or} \quad \left(\frac{V_1}{V_2}\right)^n = \frac{p_2}{p_1}$$

$$\text{or} \quad n = \frac{\ln p_2/p_1}{\ln V_1/V_2}$$

$$\text{Here} \quad n = \frac{\ln 5}{\ln 2} = \frac{1.6094}{0.6931} = 2.32$$

In a polytropic process

$$C = \frac{R}{\gamma - 1} - \frac{R}{n - 1} = \frac{R}{1.4 - 1} - \frac{R}{2.32 - 1} = 1.74 R$$

An ideal gas expands according to the law $pV^2 = \text{constant}$ (a) Is it heated or cooled? (b) What is the molar heat capacity in this process?

Solution.

This is a polytropic process of exponent $n = 2$. To find whether it is heated or cooled we have to examine whether ΔQ is +ve or -ve or whether T increases or decreases.

$$pV^2 = \text{constant.} \quad \text{But } pV = RT \quad (\text{always})$$

$$\therefore \frac{pV^2}{pV} = \frac{\text{constant}}{RT} \quad \text{or} \quad V \propto \frac{1}{T}$$

Thus when volume increases T decreases. Here the gas is cooled.

$$(b) \quad C = \frac{R}{\gamma - 1} - \frac{R}{n - 1} = C_V - R$$

Newton's Law of Cooling by Prof. Subhashish Chattopadhyay SKMClasses Bangalore Useful for IIT-JEE, CBSE, I.Sc. PU-II, Boards, CET, CEE, PET, IGCSE IB AP-Physics and other exams

Heat or Thermodynamics 2) Formula for equivalent gamma in mixture of gases. n_1 moles of gas with γ_1 and n_2 mole of gas with γ_2 are mixed, then what is equivalent gamma ?

Why $C_v = R / (\gamma - 1)$

Specific heat of a polytropic process. Derivation of work done in polytropic process.

$$\frac{n_1 + n_2}{\gamma - 1} = \frac{n_1}{\gamma_1 - 1} + \frac{n_2}{\gamma_2 - 1}$$

Equivalent γ of a mixture of gas.
 n_1 moles of γ_1 and n_2 moles of γ_2 are mixed

$$C_v = \frac{R}{\gamma - 1}$$

we have $\gamma = \frac{C_p}{C_v} = \frac{C_v + R}{C_v}$

$$= 1 + \frac{R}{C_v}$$

$$\Rightarrow \frac{R}{C_v} = \gamma - 1 \Rightarrow C_v = \frac{R}{\gamma - 1}$$

$$C = \frac{R}{\gamma_1 - 1} + \frac{R}{\gamma_2 - 1} = C_v + \frac{R}{\gamma - 1}$$

Derivation of Work done in a polytropic Process.

$$\Delta Q = n C_{poly} \Delta T$$

$$= n \left(C_v + \frac{R}{1 - \gamma} \right) (T_2 - T_1)$$

$$= n C_v \Delta T + \frac{n R \Delta T}{1 - \gamma}$$

$$= \Delta U + \Delta W$$

So $\Delta W = \text{Work done} = \frac{n R \Delta T}{1 - \gamma}$

where polytropic process is $PV^\gamma = C$

Newton's Law of Cooling by Prof. Subhashish Chattopadhyay SKMClasses Bangalore Useful for IIT-JEE, CBSE, I.Sc. PU-II, Boards, CET, CEE, PET, IGCSE IB AP-Physics and other exams

Heat or Thermodynamics 3) Work done calculations in various situations

One mole of an ideal gas is taken round the cyclic process $ABCA$ as shown in the figure. Calculate:

- (i) **The work done by the gas.**
- (ii) **The heat rejected by the gas in the path CA and the absorbed by the gas in the path BC .**
- (iii) **The net heat absorbed by the gas in the path BC .**
- (iv) **The maximum temperature attained by the gas during the cycle.**

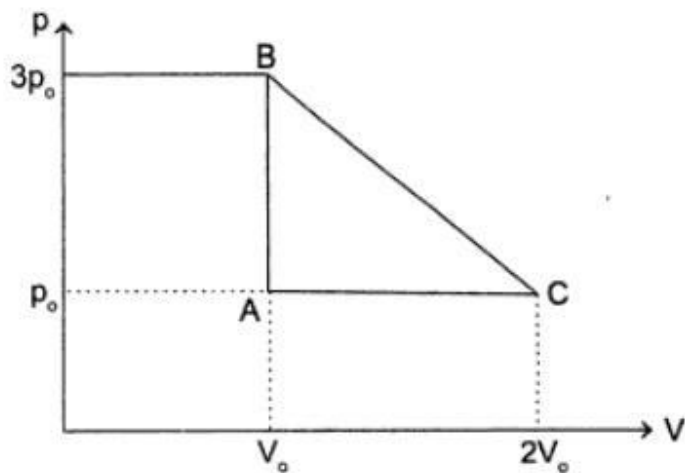

Solution

- (i) Work done by the gas during a cyclic process is equal to the area enclosed by its P-V diagram. In the present case,

$$\begin{aligned}W &= \text{area of } \Delta ABC \\&= \frac{1}{2}(AC)(AB) \\&= \frac{1}{2}(2V_0 - V_0)(3p_0 - p_0) \\&= p_0 V_0\end{aligned}$$

- (ii) The path CA is an isobaric compression of one mole of an ideal gas from volume $2V_0$ to V_0 . The heat released in this path is

$$\begin{aligned}Q_1 &= n C_p \Delta T \\&= \left(\frac{3}{2}R\right)\left(\frac{p_0 \Delta V}{R}\right) \\&= \left(\frac{5}{2}p_0\right)(V_0 - 2V_0) = -\frac{5}{2}p_0 V_0\end{aligned}$$

The path AB is an isochoric expansion of one mole of an ideal gas from pressure p_0 to $3p_0$. The heat released in this process is

$$\begin{aligned}Q_2 &= n C_v \Delta T \\&= \left(\frac{5}{2}R\right)\left(\frac{V_0 \Delta p}{R}\right) \\&= \left(\frac{3}{2}V_0\right)(3p_0 - p_0) = 3p_0 V_0\end{aligned}$$

(iii) In a cyclic process, the change in internal energy is zero. Hence

$$Q_{CA} + Q_{AB} + Q_{BC} = W$$

$$-\frac{5}{2}p_0V_0 + 3p_0V_0 + Q_{BC} = p_0V_0$$

This gives $Q_{BC} = \frac{1}{2}p_0V_0$

(iv) The path BC is a straight line path. It is represented by the expression

$$p - p_0 = \left(\frac{3p_0 - p_0}{V_0 - 2V_0} \right) (V - 2V_0)$$

$$= \left(\frac{-2p_0}{V_0} \right) (V - 2V_0)$$

or $p = \frac{-2p_0}{V_0}V + 5p_0$

Replacing $p = \frac{RT}{V}$, we get

$$T = -2\frac{p_0}{V_0R}V^2 + \frac{5V_0}{R}V$$

To determine T_{\max} , we set $\frac{\partial T}{\partial V} = 0$

i.e., $0 = -\frac{2p_0}{V_0R}(2V) + \frac{5p_0}{R}$

which gives $V = \frac{5}{4} V_0$.

With this T_{\max} is given by

$$\begin{aligned} T_{\max} &= -\frac{2p_0}{V_0 R} \left(\frac{5}{4} V_0 \right)^2 + \left(\frac{5p_0}{R} \right) \left(\frac{5}{4} V_0 \right) \\ &= \frac{p_0 V_0}{R} \left[-\frac{25}{8} + \frac{25}{4} \right] \\ &= \frac{25 p_0 V_0}{8 R} \end{aligned}$$

Three moles of an ideal gas ($C_p = \frac{7}{2} R$) at pressure p_A and temperature T_A is isothermally expanded to twice its initial volume. It is then compressed at constant pressure to its original volume. Finally the gas is compressed at constant volume to its original pressure p_A . (i) Sketch p - V and p - T diagrams for the complete process. (b) Calculate the net work done by the gas and net heat supplied to the gas during the complete process. [IIT 1991]

Solution.

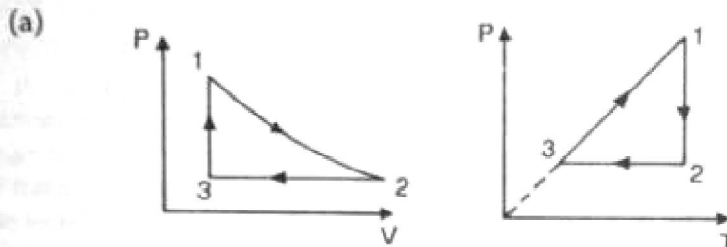

(b) In the process $1 \rightarrow 2$ the state changes from (p_A, V, T_A) to $(p_2, 2V, T_A)$.

Hence $p_2 = \frac{p_A}{2}$

Here $\Delta U = 0$ $\Delta W = \int_V^{2V} p dV = 3RT_A \ln 2$, $\Delta Q = \Delta U + \Delta W = \Delta W$

In the process $2 \rightarrow 3$ the state changes from $\left(\frac{p_A}{2}, 2V, T_A \right)$ to

$\left(p_A/2, V, T_3 \right)$ so that $\frac{p_A}{2} \times \frac{2V}{T_A} = \frac{p_A/2 \times V}{T_3}$ or $T_3 = T_A/2$

$$\gamma = \frac{C_p}{C_v} = \frac{C_p}{C_p - R} = \frac{\frac{7}{2}R}{\frac{7}{2}R - R} = \frac{7}{5}$$

$$\therefore \Delta U = -\frac{3RT_A}{\left(\frac{7}{5} - 1\right) \times 2} = -\frac{15RT_A}{4}$$

$$\Delta W = \int_{2V}^V p dV = \frac{p_A}{2} (V - 2V) = -\frac{p_A V}{2} = -\frac{3RT_A}{2}$$

$$\therefore \Delta Q = \Delta U + \Delta W = -\frac{15}{4} RT_A - \frac{3}{2} RT_A = -\frac{21RT_A}{4}$$

In the process 3 \rightarrow 1, the state changes from $\left(\frac{p_A}{2}, V, \frac{T_A}{2}\right)$ to (p_A, V, T) that

$$\frac{p_A/2 \times V}{T_A/2} = \frac{p_A V}{T} \quad \text{or} \quad T = T_A$$

$$\Delta U = 3C_v \left(T_A - \frac{T_A}{2}\right) = \frac{3R}{\frac{7}{5} - 1} \times \frac{T_A}{2} = \frac{15}{4} RT_A$$

$$\Delta W = 0$$

$$\therefore \Delta Q = \Delta U = \frac{15}{4} RT_A$$

$$\therefore \text{Net } \Delta W = 3RT_A \ln 2 - \frac{3}{2} RT_A + 0 = 3RT_A \left(\ln 2 - \frac{1}{2}\right)$$

$$\text{Net } \Delta Q = 3RT_A \ln 2 - \frac{21RT_A}{4} + \frac{15RT_A}{4} = 3RT_A \left(\ln 2 - \frac{1}{2}\right)$$

A certain volume of a gas (diatomic) expands isothermally at 20°C until its volume is doubled and then adiabatically until its volume is again doubled. Find the final temperature of the gas, given $\gamma = 1.4$ and that there is 0.1 mole of the gas. Also calculate the work done in the two cases. $R = 8.3 \text{ J mole}^{-1} \text{ K}^{-1}$.

Solution.

We require T - V relation to calculate the final temperature.

We have $TV^{\gamma-1} = \text{constant} \therefore (273 + 20) \cdot V^{\gamma-1} = (273 + t)(2V)^{\gamma-1}$

$$\text{or } 273 + t = \frac{293}{2^{1.4-1}} = \frac{293}{2^{0.4}}$$

$$\begin{aligned} \log(273 + t) &= \log 293 - 0.4 \log 2 = \log 293 - 0.4 \times 0.3010 \\ &= 2.4669 - 0.1204 \end{aligned}$$

$$\text{or } \log(273 + t) = 2.3465$$

$$\text{or } 273 + t = \text{antilog } 2.3465$$

$$\text{or } 273 + t = 222.1$$

$$\therefore t = -50.9^\circ\text{C}$$

(i) Work done in isothermal process

$$\begin{aligned} &= nRT \log_e \frac{V_2}{V_1} = \frac{8.3}{10} \times 293 \log_e \frac{2V}{V} \quad \left(\because n = \frac{1}{10} \right) \\ &= 0.83 \times 293 \times 2.3 \log_{10} 2 \quad (\because \log_e x = 2.3 \log_{10} x) \\ &= 0.83 \times 293 \times 2.3 \times 0.3010 = 1.684 \times 10^2 \text{ J} \end{aligned}$$

$$\begin{aligned} \text{(ii) Work done in adiabatic process} &= \frac{nR(T - T^*)}{\gamma - 1} = \frac{0.83(293 - 222.1)}{1.4 - 1} \\ &= \frac{0.83 \times 70.9}{0.4} = 1.47 \times 10^2 \text{ J} \end{aligned}$$

The volume of one mole of an ideal gas with the adiabatic exponent γ is changed according to the relation $V = aT^\gamma$, where a is a constant. Find the amount of heat absorbed by the gas in the process if the temperature is increased by ΔT .

Solution.

We have $\Delta W = \int pdV$ and $\Delta U = \int C_V dT$, for an ideal gas $pV = RT$,

$$\therefore \Delta W = \int_T^{T+\Delta T} \frac{RT}{V} dV = \int_T^{T+\Delta T} \frac{RT^2}{a} \left(-\frac{a}{T^2} dT \right) = -R\Delta T$$

$$\Delta U = \int_T^{T+\Delta T} \frac{R}{\gamma-1} dT = \frac{R\Delta T}{\gamma-1}$$

$$\therefore \Delta Q = \Delta U + \Delta W = \frac{R\Delta T}{\gamma-1} + (-R\Delta T) = \frac{(2-\gamma)R\Delta T}{\gamma-1}$$

Two moles an ideal mono-atomic gas initially at pressure p_1 and volume V_1 undergo an adiabatic compression until its volume is V_2 . Then, the gas is given heat Q at constant volume V_2 .

- (i) Sketch the complete process on a p - V diagram.**
- (ii) Find the total work done by the gas, total change in its internal energy and the final temperature of the gas.**

[Give your answer in terms of p_1 , V_1 , V_2 , Q and R].

Solution

- (i) Figure displays the p - V diagram of the gas undergone the given two processes.

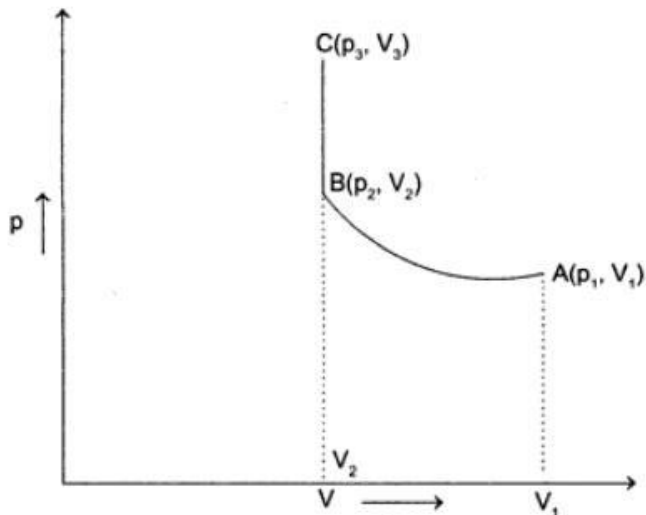

The curve A to B represents the adiabatic compression of the gas from the volume V_1 to V_2 . In this process the pressure of the gas increases p_1 to p_2 .

The line B to C represents increase in pressure of the gas as a result of giving here Q to the gas at constant volume. In this process, the pressure of the gas increases from p_2 to p_3 .

- (ii) (a) **Total work done by the gas**

Work done by the gas in adiabatic compression.

In an adiabatic process, since $Q = 0$, therefore from the first law of thermodynamics,

$$\Delta U_1 = -W_1$$

$$\text{or } W_1 = \Delta U_1 = -C_v \Delta T$$

$$= -C_v (T_2 - T_1)$$

Newton 's Law of Cooling by Prof. Subhashish Chattopadhyay SKMClasses Bangalore Useful for IIT-JEE, CBSE, I.Sc. PU-II, Boards, CET, CEE, PET, IGCSE IB AP-Physics and other exams

$$= -C_v \left(\frac{p_2 V_2}{nR} - \frac{p_1 V_1}{nR} \right)$$

$$= \frac{C_{v,m}}{R} (p_2 V_2 - p_1 V_1) \quad \dots(i)$$

For a gas underdoes adiabatic process

$$P_1 V_1^\gamma = P_2 V_2^\gamma$$

$$\text{where } \gamma = \frac{C_{p,m}}{C_{v,m}}$$

From equation (i),

$$W_1 = \frac{C_{v,m}}{R} \left[\frac{p_1 V_1^\gamma}{V_2^\gamma} V_2 - p_1 V_1 \right]$$

$$= \frac{C_{v,m}}{R} p_1 V_1 \left[\left(\frac{V_1}{V_2} \right)^{\gamma-1} - 1 \right]$$

For a mono-atomic gas,

$$C_{v,m} = \frac{3}{2}R, \text{ and } C_{p,m} = \frac{5}{2}R$$

$$\therefore \gamma = \frac{5}{3}$$

$$\text{Hence, } W_1 = -\frac{3p_1 V_1}{2} \left[\left(\frac{V_1}{V_2} \right)^{\frac{2}{3}} - 1 \right]$$

Since the volume is held constant, work done by the gas on heating at constant volume, therefore

$$W_2 = 0$$

Newton 's Law of Cooling by Prof. Subhashish Chattopadhyay SKMClasses Bangalore Useful for IIT-JEE, CBSE, I.Sc. PU-II, Boards, CET, CEE, PET, IGCSE IB AP-Physics and other exams

Total work don by the gas,

$$W = W_1 = W_2$$

$$= -\frac{3p_1V_1}{2} \left[\left(\frac{V_1}{V_2} \right)^{\frac{2}{3}} - 1 \right]$$

(b) Total change in internal Energy

Change in internal energy in adiabatic compression, as derived above,

$$\Delta U_1 = \frac{3p_1V_1}{2} \left[\left(\frac{V_1}{V_2} \right)^{\frac{2}{3}} - 1 \right]$$

Change in internal energy on heating the gas at constant volume

$$\Delta U_2 = Q$$

Total change in the internal energy of the gas

$$\Delta U = \Delta U_1 + \Delta U_2$$

$$= \frac{3p_1V_1}{2} \left[\left(\frac{V_1}{V_2} \right)^{\frac{2}{3}} - 1 \right] + Q.$$

(c) Final temperature of the gas

Change in temperature in adiabatic compression.

Since, $\Delta U = C_v \Delta T$

Newton 's Law of Cooling by Prof. Subhashish Chattopadhyay SKMClasses Bangalore Useful for IIT-JEE, CBSE, I.Sc. PU-II, Boards, CET, CEE, PET, IGCSE IB AP-Physics and other exams

$$\text{therefore, } \Delta T = \frac{\Delta U_1}{C_v}$$

$$\text{or } T_2 - T_1 = \frac{3p_1V_1}{2C_v} \left[\left(\frac{V_1}{V_2} \right)^{2/3} - 1 \right]$$

$$T_2 - T_1 + \frac{3p_1V_1}{2 \left(\frac{3}{2} nR \right)} \left[\left(\frac{V_1}{V_2} \right)^{2/3} - 1 \right]$$

$$= \frac{p_1V_1}{nR} + \frac{p_1V_1}{nR} \left[\left(\frac{V_1}{V_2} \right)^{2/3} - 1 \right]$$

$$= \frac{p_1V_1}{nR} \left(\frac{V_1}{V_2} \right)^{2/3}$$

Change in temperature on heating the gas

$$Q = C_v \Delta T = C_v (T_3 - T_2)$$

$$\text{or } T_3 = \frac{Q}{C_v} + T_2 = \frac{Q}{\left(\frac{3}{2} \right) nR} + \frac{p_1V_1}{nR} \left(\frac{V_1}{V_2} \right)^{2/3}$$

Since $n = 2$, therefore

$$T_3 = \frac{Q}{(3 \text{ mole})R} + \frac{p_1V_1}{(2 \text{ mole})R} \left(\frac{V_1}{V_2} \right)^{2/3}.$$

Newton 's Law of Cooling by Prof. Subhashish Chattopadhyay SKMClasses Bangalore Useful for IIT-JEE, CBSE, I.Sc. PU-II, Boards, CET, CEE, PET, IGCSE IB AP-Physics and other exams

Two moles of helium gas ($\gamma = 5/3$) are initially at temperature 27°C and occupy a volume of 20 litres. The gas is expanded

at constant pressure until the volume is doubled. Then, it undergoes an adiabatic change until the temperature returns to its initial value.

- (i) Sketch the process on a p-V diagram.
- (ii) What are the final volume and pressure of the gas?
- (iii) What is the work done by the gas?

Solution

(i) $V_1 = 20 \times 10^{-3} \text{ m}^3$

$T_1 = 300 \text{ K}$

$n = 2 \text{ moles}$

$\gamma = \frac{5}{3}$

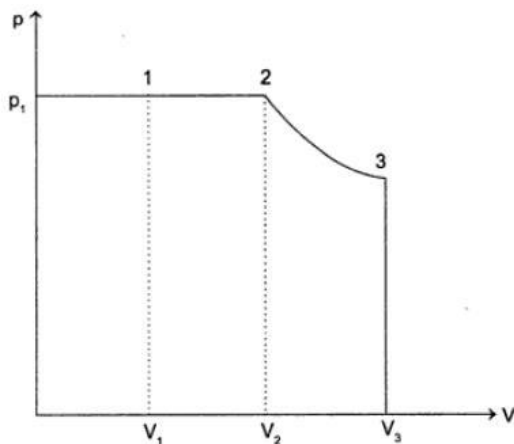

Process 1 \rightarrow 2 is isobaric expansion

$$p_1 V_1 = nRT_1$$

$$\therefore p_1 = \frac{nRT_1}{V_1}$$

$$= \frac{2 \times 8.3 \times 300}{20 \times 10^{-3}} = 2.49 \times 10^5 \text{ Nm}^{-2}$$

Now, $V \propto T$

$$\therefore \frac{V_1}{T_1} = \frac{V_2}{T_2}$$

$$\text{or } T_2 = T_1 \times \frac{V_2}{V_1} = 300 \times \frac{2V_1}{V_1}$$

$$\therefore T_2 = 600 \text{ K}$$

$$V_2 = 40 \times 10^{-3} \text{ m}^3$$

Work done during process 1 \rightarrow 2,

$$(W)_{1-2} = p \times \Delta V$$

$$= 2.49 \times 10^5 \times (40 - 20) \times 10^{-3}$$

$$= 4980 \text{ J}$$

Process 2 \rightarrow 3 is adiabatic expansion

$$T_2 = 600 \text{ K}$$

$$p_2 = p_1 = 2.48 \times 10^5 \text{ N/m}^2$$

$$V_2 = 40 \times 10^{-3} \text{ m}^3$$

Given, $T_2 V_2^{\gamma-1} = T_3 V_3^{\gamma-1}$, $T_3 = T_1$

$$\therefore \left(\frac{V_3}{V_2} \right)^{\frac{5}{3}-1} = \frac{T_2}{T_1} = \frac{600}{300} = 2$$

$$\therefore V_3 = V_2 \times (2)^{3/2}$$

$$= 40 \times 10^{-3} (2)^{3/2}$$

$$= 113.14 \times 10^{-3} \text{ m}^3$$

$$\text{Now, } p_2 V_2^\gamma = P_3 V_3^\gamma$$

$$\therefore p_3 = p_2 \left(\frac{V_2}{V_3} \right)^\gamma$$

$$= 2.48 \times 10^5 \left(\frac{40}{113.14} \right)^{5/3} = 0.44 \times 10^5 \text{ N/m}^2$$

$$(W)_{2-3} = \frac{p_2 V_2 - p_3 V_3}{\gamma - 1}$$

$$= \frac{(2.49 \times 10^5)(40 \times 10^{-3}) - (0.44 \times 10^5)(113.14 \times 10^{-3})}{(5/3) - 1}$$

$$= 7472.8 \text{ J.}$$

(ii) Final volume, $V_3 = 113.14 \times 10^{-3} \text{ m}^3$

Final pressure, $p_3 = 0.44 \times 10^5 \text{ Nm}^{-2}$

(iii) Total work done by the gas = $W =$

$$(W)_{1-2} + (W)_{2-3}$$

$$= 4980 + 7472.8 = 12452.8 \text{ J.}$$

Work done example in Isothermal expansion

A gram mole of a gas at 127°C expands isothermally until its volume is doubled. Find the amount of work done.

(a) 238 cal

(b) 548 cal

(c) 548 J

(d) 238 J

$$(b) W = 2.303 RT \log_{10} \left(\frac{V_2}{V_1} \right)$$

$$= 2.303 \times 8.311 \times 400 \times \log_{10} 2$$

$$= 2310.1 \text{ J} = 548 \text{ cal.}$$

Example in Isothermal Expansion

How much work is done by an ideal gas in expanding isothermally from an initial volume of 3 litres of 20 atm to a final volume of 24 litres?

Solution In isothermal process at temperature T,

$$W = 2.303nRT \log \frac{V_2}{V_1}$$

or $W = 2.303(p_1 V_1) \log \frac{V_2}{V_1}$

(using $p_1 V_1 = nRT$)

$$= 2.303 (20 \times 3) \log \frac{P_1}{P_2} \text{ lt. atm}$$

$$= 2.303 \times 60 \log 8 (101) \text{ J}$$

$$= \mathbf{1.26 \times 10^4 \text{ J}}$$

One mole of a gas which obeys the relation $Pv = RT$, where $R = 8.314 \text{ J/mol K}$ is initially at 300 K and 0.1 MPa . The gas is heated at constant volume till the pressure rises to 0.5 MPa and then allowed to expand at constant temperature till the pressure reduces to 0.1 MPa . Finally the gas is returned to its original state by compressing at constant pressure. Calculate the work done by the gas in each of the processes and also estimate the net work done by the gas.

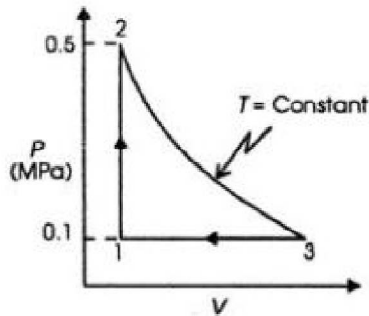

P-V diagram .

Solution The process followed by the gas is shown in Fig.2.12. Work done by the gas during process 1-2 is given by

$$W_{1-2} = \int_1^2 Pdv = 0 \quad (\text{since } dv = 0)$$

We know $P_1v_1 = RT_1$ and $P_2v_2 = RT_2$. Therefore

$$\frac{T_2}{T_1} = \frac{P_2v_2}{P_1v_1} = \frac{P_2}{P_1} = \frac{0.5 \times 10^6}{0.1 \times 10^6} = 5 \quad (\text{since } v_2 = v_1)$$

or $T_2 = 5T_1 = 5 \times 300 = 1500 \text{ K}$

Work done by the gas during process 2-3 is given by

$$W_{2-3} = \int_2^3 Pdv = \int_2^3 \frac{RT}{v} dv = RT_2 \ln \frac{v_3}{v_2}$$

We know $P_2v_2 = P_3v_3$ (since $T_2 = T_3$). Therefore

$$\frac{v_3}{v_2} = \frac{P_2}{P_3} = \frac{0.5 \times 10^6}{0.1 \times 10^6} = 5$$

Hence $W_{2-3} = RT_2 \ln 5 = 8.314 \times 1500 \times \ln 5 = 20.071 \text{ kJ}$. Work done during process 3-1 is given by

$$W_{3-1} = \int_3^1 Pdv = P_1(v_1 - v_3) = P_1v_1 \left(1 - \frac{v_3}{v_1}\right) = RT_1 \left(1 - \frac{v_3}{v_1}\right)$$

We know $P_1v_1 = RT_1$ and $P_3v_3 = RT_3$

$$\text{or } \frac{v_3}{v_1} = \frac{RT_3}{P_3} \cdot \frac{P_1}{RT_1} = \frac{T_3}{T_1} \quad (\text{since } P_1 = P_3). \text{ Therefore}$$

$$W_{3-1} = RT_1 \left(1 - \frac{v_3}{v_1}\right) = RT_1 \left(1 - \frac{T_3}{T_1}\right) = 8.314 \times 300 \left(1 - \frac{1500}{300}\right) = -9.977 \text{ kJ}$$

$$\text{Net work done by the gas, } W = W_{1-2} + W_{2-3} + W_{3-1} = 0 + 20.071 - 9.977 = 10.094 \text{ kJ}$$

Work done by the gas

A sample of ideal gas ($\gamma = 1.4$) is heated at constant pressure. If an amount of 140 J of heat is supplied to the gas, find:

- (i) **The change in internal energy of the gas.**
- (ii) **The work done by the gas.**

Solution Suppose, the sample contains n moles. Also, suppose the volume changes from V_1 to V_2 and the temperature changes from T_1 to T_2 .

The heat supplied is given by

$$\Delta Q = nC_p(T_2 - T_1)$$

- (i) **Change in internal energy**

$$\Delta U = nC_v(T_2 - T_1)$$

$$= \frac{C_v}{C_p} nC_p(T_2 - T_1)$$

$$= \frac{C_v}{C_p} \Delta Q = \frac{140 \text{ J}}{1.4} = \mathbf{100 \text{ J}}$$

- (ii) **Work done by gas**

$$\Delta W = \Delta Q - \Delta U$$

$$= 140 \text{ J} - 100 \text{ J} = \mathbf{40 \text{ J}}$$

work done by the gas

A sample of gas ($\gamma = 1.5$) is taken through an adiabatic process in which the volume is compressed from 1600 cm^3 to 400 cm^3 . If the initial pressure is 150 kPa ,

- (i) **What is the final pressure?**
- (ii) **How much work is done by the gas in the process?**

Solution

- (i) For an adiabatic process

$$p_1 V_1^\gamma = p_2 V_2^\gamma$$

$$\begin{aligned}\text{Thus, } p_2 &= p_1 \left(\frac{V_1}{V_2} \right)^\gamma \\ &= (150 \text{ kPa}) \left(\frac{1600}{400} \right)^{\frac{3}{2}} \\ &= \mathbf{1200 \text{ kPa}}\end{aligned}$$

- (ii) Work done by the gas in an adiabatic process

$$\begin{aligned}W &= \frac{p_1 V_1 - p_2 V_2}{\gamma - 1} \\ &= \frac{(150 \text{ kPa})(1600 \text{ cm}^3) - (1200 \text{ kPa})(400 \text{ cm}^3)}{1.5 - 1} \\ &= \frac{240 \text{ J} - 480 \text{ J}}{0.5} = \mathbf{-480 \text{ J}}\end{aligned}$$

A cyclic process for an ideal monatomic gas ($C_v = 12.5 \text{ J mol}^{-1} \text{ K}^{-1}$) is represented in the figure. The temperatures at 1, 2 and 3 are 300 K, 600 K and 455 K, respectively. Compute the values of ΔQ , ΔU and ΔW for each of the processes. The process from 2 to 3 is adiabatic.

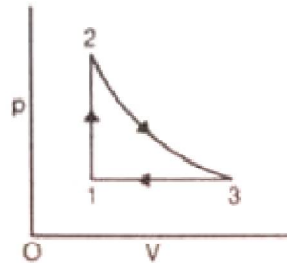

Solution.

In the process from 1 to 2

$$\Delta W = \int p dV = 0 \quad (\text{volume remains constant})$$

$$\begin{aligned} \Delta Q &= \int_{T_1}^{T_2} C_v dT = C_v(T_2 - T_1) \\ &= 12.5(600 - 300) = 3750 \text{ joules} \end{aligned}$$

By the first law of thermodynamics

$$\begin{aligned} \Delta Q &= \Delta U + \Delta W \quad \text{or} \quad \Delta U = \Delta Q - \Delta W \\ &= 3750 - 0 = 3750 \text{ joules} \end{aligned}$$

In the process 2 to 3 $\Delta Q = 0$
(since the process is adiabatic)

$$\begin{aligned}\Delta W &= \frac{R(T_2 - T_3)}{\gamma - 1} \\ &= C_V (T_2 - T_3) \quad \left(\because C_V = \frac{R}{\gamma - 1} \right) \\ &= 12.5(600 - 455) = 12.5 \times 145 = 1812.5 \text{ joules}\end{aligned}$$

$$\therefore \Delta U = \Delta Q - \Delta W = 0 - 1812.5 = -1812.5 \text{ joules}$$

$$\text{In the process from 3 to 1, } \Delta W = \int_V^{V_1} p dV = p(V_1 - V_3) = pV_1 - pV_3$$

$$\begin{aligned}\text{or } \Delta W &= R(T_1 - T_3) \quad (\because pV = RT) \\ &= 8.31(300 - 455) = -1288 \text{ joules}\end{aligned}$$

$$\begin{aligned}\Delta Q &= \int_{T_3}^{T_1} C_p dT = C_p(T_1 - T_3) = 1.67 \times 12.5 \times (300 - 455) \quad \left(\because \gamma = \frac{C_p}{C_v} \right) \\ &= -3235.6 \text{ joules.}\end{aligned}$$

By the first law of thermodynamics

$$\Delta Q = \Delta U + \Delta W$$

$$\therefore \Delta U = \Delta Q - \Delta W = (-3235.6) - (-1288) = 1989.1 \text{ joules}$$

Question on Total Heat rejected

A thermodynamic system is taken through the cycle $a b c d a$.

(i) Calculate the work done by the gas during the parts ab , bc , cd and da .

(ii) Find the total heat rejected by the gas during the process.

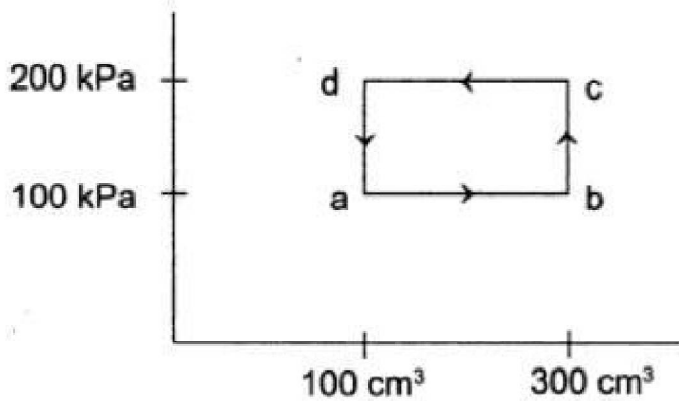

Solution

(i) Work done during the part $ab = \int_a^b p dV$

$$\begin{aligned} &= (100 \times \text{Pa}) \int_a^b dV \\ &= (100 \text{ kPa}) (300 \text{ cm}^3 - 100 \text{ cm}^3) \\ &= 20 \text{ J} \end{aligned}$$

The work done during bc is zero as the volume does not change. The work done during cd ,

$$\begin{aligned} &= \int_d^c p dV \\ &= (200 \text{ kPa}) (100 \text{ cm}^3 - 300 \text{ cm}^3) \\ &= -40 \text{ J} \end{aligned}$$

The work done during da is zero as the volume does not change.

(ii) Total work done by the system during the cycle $a b c d a$.

$$\Delta W = 20 \text{ J} - 40 \text{ J}$$

$$= -20 \text{ J}$$

Change in the internal energy, $\Delta U = 0$, as the initial state is the same as the final state.

$$\begin{aligned} \text{Thus, } \Delta Q &= \Delta U + \Delta W \\ &= -20 \text{ J} \end{aligned}$$

So, the system rejects **20 J** of heat during the cycle.

- Question with P T diagram

3 moles of an ideal monoatomic gas perform a cycle shown in Fig. The gas temperatures $T_A = 400 \text{ K}$, $T_B = 800 \text{ K}$, $T_C = 2400 \text{ K}$, $T_D = 1200 \text{ K}$. Find the work done by the gas.

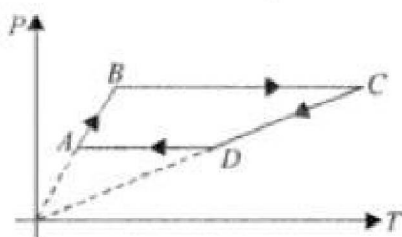

Solution :

$$W_{BC} = 3R(T_C - T_B)$$

$$W_{AB} = W_{CD} = 0$$

because the processes are isochoric

$$W_{DA} = 3R(T_A - T_D)$$

Total work done

$$\begin{aligned} W_{BC} + W_{DA} &= 3R(T_A + T_C - T_B - T_D) \\ &= 3R(400 + 2400 - 800 - 1200) \\ &= 2400R = 20 \text{ kJ} \end{aligned}$$

Work done by the gas

Two moles of Helium gas ($\gamma = \frac{5}{3}$) are initially at 27°C and occupy a volume of 20 litres. The gas is first expanded at constant pressure until the volume is doubled. Then it undergoes an adiabatic change until the temperature returns to its initial value.

- (i) Sketch the process in a p–V diagram.
- (ii) What is the final volume and pressure of the gas?
- (iii) What is the work done by the gas?

Solution

- (i) The process is shown in the figure. During the part *ab*, since the pressure is constant, we have

$$\frac{P_a V_a}{T_a} = \frac{P_b V_b}{T_b}$$

$$\begin{aligned} \text{or } T_b &= \frac{V_b}{V_a} T_a \\ &= 2T_a = 600 \text{ K} \end{aligned}$$

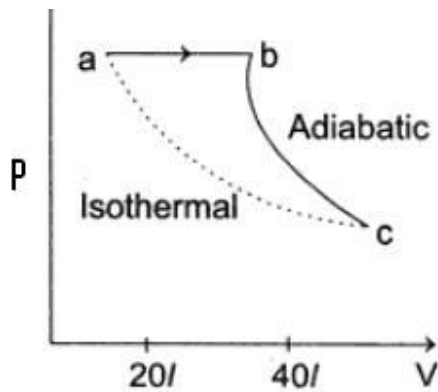

During the part bc , the gas is adiabatically returned to the temperature T_a . The point a and point c are on the same isothermal. Thus, we draw an adiabatic curve bc and an isothermal from a and look for the point of intersection c . That is the final state.

(ii) From the isothermal ac ,

$$p_a V_a = p_b V_b \quad \dots(i)$$

And from the adiabatic curve bc ,

$$p_b V_b^\gamma = p_c V_c^\gamma$$

$$\text{or } p_a (2V_a)^\gamma = p_c V_c^\gamma$$

Dividing equation (ii) by equation (i), we get

$$2^\gamma (V_a)^{\gamma-1} = (V_c)^{\gamma-1}$$

$$\begin{aligned} \text{or } V_c &= 2^{\frac{\gamma}{\gamma-1}} V_a 4\sqrt{2} V_a \\ &= 113 \text{ litres} \end{aligned}$$

From equation (i),

$$\begin{aligned} p_c &= \frac{p_a V_a}{V_c} = \frac{nRT}{V_c} \\ &= \frac{2 \text{ mol} \times (8.3 \text{ J/mol} \cdot \text{K})(300 \text{ K})}{113 \times 10^{-3} \text{ m}^3} \\ &= 4.4 \times 10^4 \text{ Pa} \end{aligned}$$

(iii) Work done by the gas in the part *ab*

$$\begin{aligned} &= p_a (V_b - V_a) \\ &= p_a V_b - p_a V_a = nRT_2 - nRT_1 \\ &= 2 \text{ mole} \times (8.3 \text{ J/mol} \cdot \text{K}) \times (600 \text{ K} - 300 \text{ K}) \\ &= 4980 \text{ J} \end{aligned}$$

Work done in the adiabatic part *bc*

$$\begin{aligned} &= \frac{p_b V_b - p_c V_c}{\gamma - 1} \\ &= \frac{nR(T_2 - T_1)}{\gamma - 1} = \frac{4980}{\frac{5}{3} - 1} = 7470 \text{ J} \end{aligned}$$

Net work done by the gas = 4980 J + 7470 J = **12450 J.**

Example of cycle given P T diagram

Two moles of helium gas undergo a cyclic process as shown in the figure. Assuming the gas to be ideal, calculate the following quantities in this process:

- (i) **The net change in the heat energy.**
 - (ii) **The net work done.**
 - (iii) **The net change in internal energy.**
- [R = 8.32 J mol⁻¹]**

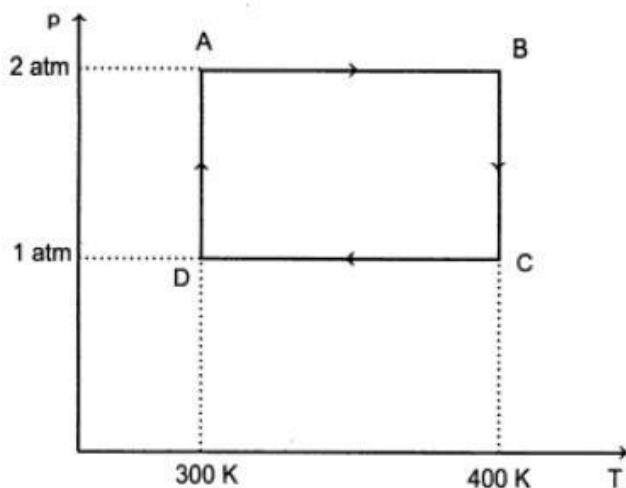

Solution Number of moles, $n = 2$
Helium is a mono-atomic gas.

$$\therefore C_V = \frac{3}{2}R$$

$$C_P = \frac{5}{2}R$$

The gas undergoes cyclic process.

Since, internal energy is property of the system, the net change in internal energy during the cyclic process is zero.

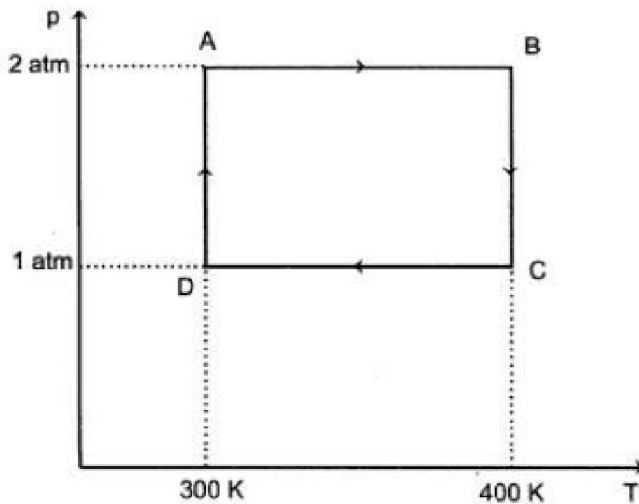

Hence, according to the first law of thermodynamics, the net change in the heat energy is equal to the net work done.

$$(i) (\Delta Q)_{Net} = (\Delta Q)_{AB} + (\Delta Q)_{BC} + (\Delta Q)_{DA}$$

$$\begin{aligned} (\Delta Q)_{AB} &= n \times C_p \times (T_B - T_A) \\ &= 2 \times \frac{5}{2} \times 8.32(400 - 300) = 4160 \text{ J} \end{aligned}$$

Since Process BC is isothermal, therefore $\Delta U = 0$

$$\begin{aligned} (\Delta Q)_{BC} &= (\Delta W)_{BC} \\ &= nRT \ln\left(\frac{V_C}{V_B}\right) = nRT \ln\left(\frac{P_B}{P_C}\right) \\ &= 2 \times 8.32 \times 400 \ln\left(\frac{2}{1}\right) = 4613.6 \text{ J} \end{aligned}$$

$$\begin{aligned} (\Delta Q)_{DA} &= nRT \ln\left(\frac{P_D}{P_A}\right) \\ &= 2 \times 8.32 \times 300 \ln\left(\frac{2}{1}\right) = -3460.2 \text{ J} \end{aligned}$$

Efficiency of Refrigerator is given by

Efficiency of Refrigerator

$$\eta = 1 - \frac{T_c}{T_H}$$

So in this case efficiency $\eta = 1 - (273 / 303) = 0.099 \approx (\text{approx}) 0.1$ or 10%

Refrigerator Problem

A refrigerator works between 0°C and 27°C. Heat is to be removed from the refrigerated space at the rate of 50 kcal/minute, the power of the motor of the refrigerator is :

- (a) 0.346 kW (b) 3.46 kW
(c) 34.6 kW (d) 346 kW

Ans : a)

$$\begin{aligned} \frac{T_2}{T_1 - T_2} &= \frac{Q_2}{W} \\ \frac{273}{300 - 273} &= \frac{50,000}{W} \\ W &= \frac{27 \times 50,000}{273} \text{ cal / min} \\ P &= \frac{W}{t} = \frac{4.2 \times 27 \times 50,000}{60 \times 273} \text{ Joule / sec} \\ &= 346 \text{ watt} = 0.346 \text{ kW} \end{aligned}$$

Efficiency of Refrigerator

$$\eta = 1 - \frac{T_c}{T_H}$$

So in this case efficiency $\eta = 1 - (273 / 300) = 0.09 \approx$ or 9%

Refrigerator Problem

An ideal refrigerator has a freezer at a temperature of $-13\text{ }^{\circ}\text{C}$. The coefficient of performance of the engine is 5. The temperature of the air (to which heat is rejected) is :

- (a) 320°C (b) 39°C (c) 325 K (d) 325°C

Ans : b)

$$T_2 = 273 - 13 = 260, K = \frac{T_2}{T_1 - T_2}$$

$$5 = \frac{260}{T_1 - 260} \quad \text{or} \quad T_1 - 260 = 52$$

$$T_1 = 312\text{ K}, T_2 = 312 - 273 = 39\text{ }^{\circ}\text{C}$$

Efficiency of Refrigerator

$$\eta = 1 - \frac{T_c}{T_h}$$

So in this case efficiency $\eta = 1 - (260 / 312) = 0.16666 \approx (\text{approx}) 0.16667$ or 16.67%

Refrigerator Problem

A Carnot's engine works as a refrigerator between 250 K and 300 K . If it receives 750 calories of heat from the reservoir at the lower temperature, the amount of heat rejected at the higher temperature is :

- (a) 900 calories (b) 625 calories
(c) 750 calories (d) 1000 calories

Ans : a)

$$\frac{750}{W} = \frac{250}{300 - 250}$$

$$\text{Heat rejected} = 750 + 150 = 900\text{ cal.}$$

Efficiency of Refrigerator

$$\eta = 1 - \frac{T_c}{T_H}$$

So in this case efficiency $\eta = 1 - (250 / 300) = 0.166666 \approx (\text{approx}) 0.16667$ or 16.67%

Refrigerator Problem

A refrigerator having a coefficient of performance of 5 is run by an electric motor of power 1.2 kW. How much is the mass of ice formed from water at 0°C per hour by the refrigerator ?

- (a) nearly 6 kg (b) nearly 60 kg
(c) nearly 25.2 kg (d) 252 kg

Ans : b)

$$5 = \frac{Q_2}{Pt} \quad \text{or} \quad Q_2 = 5 \times 1.2 \times 1000 \times 3600 \text{ J}$$

$$Q = 216 \times 10^5 \text{ J} = 5142857 \text{ cal.}$$

$$\therefore Q = mL \quad \text{or} \quad m = Q/L = 64.2 \text{ kg} \quad \therefore m \approx 60 \text{ kg}$$

Heat or Thermodynamics 5) Concept of "free expansion"

Free expansion:

If a system (a gas), expands in such a way that no heat enters or leaves the system (adiabatic process) and also no work is done by or on the system, then the expansion is called the free expansion.

Consider an adiabatic vessel with rigid walls divided into two parts. One containing a gas and the other evacuated. When the partition is suddenly broken, the gas rushes into the vacuum and expands freely.

∴ Net change in internal energy
 $U_f - U_i = \Delta Q - W$ as $\Delta Q = 0$ and $W = 0$
 ∴ $U_i = U_f$

The initial and final internal energies are equal in free expansion.

One mole of an ideal diatomic gas underwent an adiabatic expansion from 298 K, 15.00 atm, and 5.25 L to 2.50 atm against a constant external pressure of 1.00 atm. What is the final temperature of the system?

Plan This is an isobaric adiabatic expansion against constant external pressure, but overall pressure decreases (volume increases, gas expands). Final temperature T_2 is given by P-V-T relation as:

$$T_2 = T_1 \left(\frac{C_V + P_{\text{ext}} \frac{R}{P_1}}{C_V + P_{\text{ext}} \frac{R}{P_2}} \right)$$

Solution For diatomic gas $C_V = \frac{5}{2}R$, $T_1 = 298 \text{ K}$, $T_2 = ?$,

$P_2 = 2.50 \text{ atm}$, $P_1 = 15.00 \text{ atm}$, $P_{\text{ext}} = 1.00 \text{ atm}$

$$\begin{aligned} \therefore T_2 &= 298 \left(\frac{\frac{5}{2}R + \frac{R}{15}}{\frac{5}{2}R + \frac{R}{2.5}} \right) \\ &= 263.7 \text{ K} \end{aligned}$$

One mole of a gas is put under a weightless piston of a vertical cylinder at temperature T . The space over the piston is atmosphere. How much work should be performed to increase isothermally the

volume under the piston to twice the volume (neglect friction of piston).

Solution Let A be the area of piston, therefore

$$F + pA = p_0 A$$

or $F = (p_0 - p) A$

Work done by agent is given by

$$\begin{aligned} W &= \int_v^{\eta v} (p_0 - p) A dx \\ &= \int_v^{\eta v} (p_0 - p) dV \\ &= \int_v^{\eta v} p_0 dV - \int_v^{\eta v} p dV \end{aligned}$$

Newton 's Law of Cooling by Prof. Subhashish Chattopadhyay SKMClasses Bangalore Useful for IIT-JEE, CBSE, I.Sc. PU-II, Boards, CET, CEE, PET, IGCSE IB AP-Physics and other exams

$$= p_0(\eta - 1)V - \int_V^{\eta V} nRT \frac{dV}{V}$$

(since $pV = nRT$)

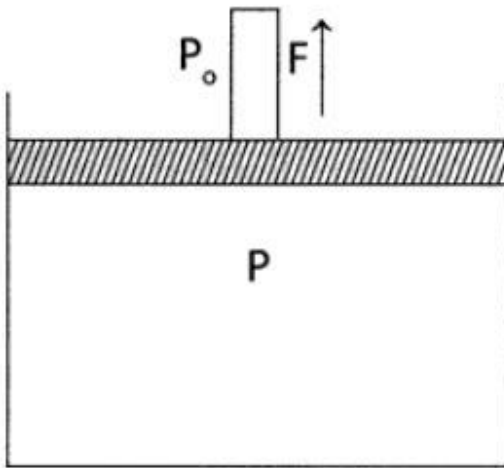

$$= p_0(\eta - 1)V - nRT \log_e \eta$$

$$= nRT [(\eta - 1) \log_e \eta]$$

where, $\eta = 2$ and $n = 1$

$$\mathbf{W = RT [1 - \log_e 2]}$$

Newton 's Law of Cooling by Prof. Subhashish Chattopadhyay SKMClasses Bangalore Useful for IIT-JEE, CBSE, I.Sc. PU-II, Boards, CET, CEE, PET, IGCSE IB AP-Physics and other exams

Adiabatic free expansion

Two vessels of volume V_1 and V_2 contain the same ideal gas. The pressure in the vessels are p_1 and p_2 and the temperatures are T_1 and T_2 respectively. The two vessels are now connected to each other through a narrow tube. Assuming that no heat is exchanged between the surroundings and the vessels, find the common pressure and temperature attained after the connection.

Solution

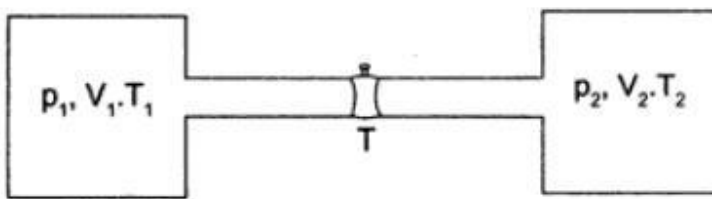

The amount of gas in vessel 1 is

$$n_1 = \frac{p_1 V_1}{RT_1}$$

If p' and T' are the common pressure and temperature after the connection is made, the amount are

$$n'_1 = \frac{p'V_1}{RT'}$$

and $n'_2 = \frac{p'V_2}{RT'}$

We have, $n_1 + n_2 = n'_1 + n'_2$

or $\frac{p_1V_1}{RT_1} + \frac{p_2V_2}{RT_2} = \frac{p'V_1}{RT'} + \frac{p'V_2}{RT'}$

or $\frac{p'}{T'} = \frac{1}{V_1 + V_2} \left(\frac{p_1V_1}{T_1} + \frac{p_2V_2}{T_2} \right)$

or $\frac{T'}{P'} = \frac{T_1T_2(V_1 + V_2)}{p_1V_1T_2 + p_2V_2T_1}$

As the vessels have fixed volume, no work done by the gas plus the vessels system. Also, no heat is exchanged with the surroundings.

Thus, the internal energy of the total system remains constant. The internal energy of an ideal gas is

$$U = nC_vT = C_v \frac{pV}{R}$$

Internal energy of the gases before the connection

$$= \frac{C_v p_1 V_1}{R} + \frac{C_v p_2 V_2}{R}$$

And Internal energy of the gas after the connection

$$= \frac{C_v p' (V_1 + V_2)}{R}$$

Neglecting the change in internal energy of the vessels (the heat capacity of the vessels is assumed negligible).

Newton 's Law of Cooling by Prof. Subhashish Chattopadhyay SKMClasses Bangalore Useful for IIT-JEE, CBSE, I.Sc. PU-II, Boards, CET, CEE, PET, IGCSE IB AP-Physics and other exams

$$\frac{C_v p_1 V_1}{R} + \frac{C_v p_2 V_2}{R} = \frac{C_v p' (V_1 + V_2)}{R}$$

or
$$p' = \frac{p_1 V_1 + p_2 V_2}{V_1 + V_2}$$

From equation (i),
$$T' = \frac{T_1 T_2 p_1 V_1 + p_2 V_2}{p_1 V_1 T_2 + p_2 V_2 T_1}$$

Question on work done

One mole of an ideal gas is contained under a weightless piston of a vertical cylinder at a temperature T . The space over the piston opens into the atmosphere. What work has to be performed in order to increase isothermally the gas volume under the piston η times by slowly raising the piston? Neglect friction.

Newton 's Law of Cooling by Prof. Subhashish Chattopadhyay SKMClasses Bangalore Useful for IIT-JEE, CBSE, I.Sc. PU-II, Boards, CET, CEE, PET, IGCSE IB AP-Physics and other exams

Solution :

Let A be the area of cross section

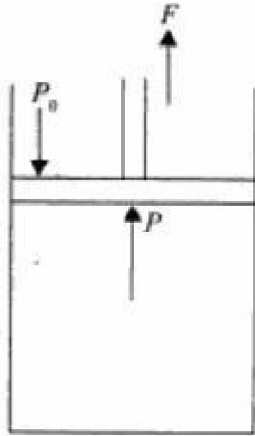

$$F + PA = P_0 A$$

$$F = (P_0 - P) A$$

Work done by the agent

$$W = \int_V^{\eta V} F dx = \int_V^{\eta V} (P_0 - P) A dx$$

$$= \int_V^{\eta V} (P_0 - P) dV$$

$$= P_0(\eta - 1) V - \int_V^{\eta V} nRT \frac{dV}{V}$$

$$= RT [(\eta - 1) - n \log_e \eta]$$

Heat or Thermodynamics 6) Ingen Housz's experiment of identical rods

Ingen-Housz's experiment Ingen Housz showed that if a number of identical rods of different metals are coated with wax and one of their ends is put in boiling water, then in steady state, the square of length of the bar over which wax melts is directly proportional to the thermal conductivity of the metal. That is,

$$\frac{K}{L^2} = \text{constant}$$

Heat or Thermodynamics 7) Concept of Internal Energy at Room temperature

Find the internal energy of air in a room of volume 40 m^3 at 1 standard atmospheric pressure.

Solution.

We have $U = \frac{pV}{\gamma - 1}$ for a perfect gas

Air is diatomic and therefore its γ is 1.4.

$$\therefore U = \frac{10^5 \times 40}{1.4 - 1} \quad (p = 1 \text{ atm} = 10^5 \text{ Nm}^{-2}) = 10^7 \text{ joules.}$$

Question in Internal Energy

The internal energy of a mono-atomic ideal gas is $1.5 nRT$. One mole of helium is kept in a cylinder of cross-section 8.5 cm^2 . The cylinder is closed by a light frictionless piston. The gas is heated slowly in a process during which a total

of 42 J heat is given to the gas. If the temperature rised through 2° C, find the distance moved by piston. Atmospheric pressure = 100 kPa.

Solution Change in internal energy of the gas

$$\begin{aligned}\Delta U &= 1.5 nRT \\ &= 1.5 (1 \text{ mole}) (8.3 \text{ J/mol} - \text{K}) (2\text{K}) \\ &= 24.9 \text{ J}\end{aligned}$$

Heat given to the gas = 43 J

$$\begin{aligned}\text{Work done by the gas is } \Delta W &= \Delta Q - \Delta U \\ &= 42 \text{ J} - 24.9 \text{ J} = 17.1 \text{ J}\end{aligned}$$

If the distance moved by the piston is x , then the work done

$$\begin{aligned}\Delta W &= (100 \text{ kPa}) (8.5 \text{ cm}^2)x \\ &= 17.1 \text{ J}\end{aligned}$$

$$\text{Thus, } (10^5 \text{ N/m}^2) (8.5 \times 10^{-4} \text{ m}^2) x = 17.1 \text{ J}$$

$$\text{or } x = 0.2 \text{ m} = \mathbf{20 \text{ cm}}$$

Heat or Thermodynamics 8) Saturated vapor pressure problems

A saturated water vapour ($M = 18$) is contained in a vessel fitted with a piston at a temperature $t = 100^\circ\text{C}$. As a result of slow introduction of the piston a small fraction of the vapour $\Delta m = 1 \text{ g}$ gets condensed. What amount of work is done over the gas?

Solution.

Work done = decrease in internal energy of the gas

$$\begin{aligned} &= U_i - U_f = \frac{m_i RT}{M} - \frac{m_f RT}{M} = \frac{\Delta m RT}{M} \\ \therefore \text{ Here, } W &= \frac{10^{-3} \times 8.3 \times (273 + 100)}{18 \times 10^{-3}} = 172 \text{ J.}\end{aligned}$$

Water of mass $m = 1 \text{ kg}$ and M (mol. mass) = 18 turns completely into saturated vapour at standard atmospheric pressure. Assuming the saturated vapour to be an ideal gas find increment of internal energy of the system. Specific latent heat of steam is $L = 2250 \text{ kJ/kg}$.

Solution.

$$\Delta Q = \text{heat added to the system} = mL$$

$$\Delta W = \text{work done by the system} = p_0 (V_v - V_w)$$

$$\approx p_0 V_v = \frac{m}{M} RT$$

By the first law ($\Delta Q = \Delta U + \Delta W$),

$$\Delta U = mL - \frac{m}{M} RT = m \left(L - \frac{RT}{M} \right)$$

$$\Delta U = 1 \left(2250 \times 10^3 - \frac{8.3 \times 373}{18 \times 10^{-3}} \right) = 2.078 \times 10^6 \text{ J}$$

Heat or Thermodynamics 9) Mean free path

Mean free path of a gas molecule between 2 collisions

Mean Free Path

all particles, including photons, suffer from collisions with other particles such that their path through space is very short the higher the densities. This typical path length is called the mean free path.

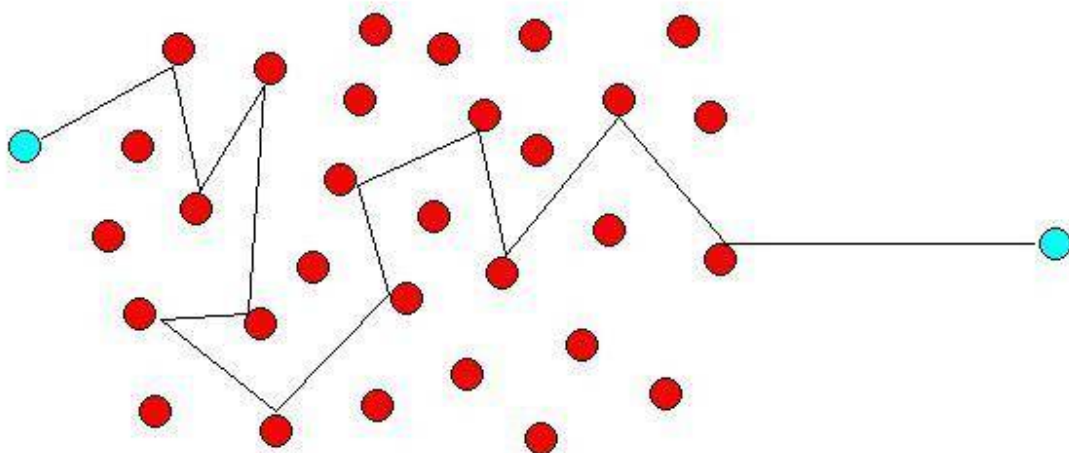

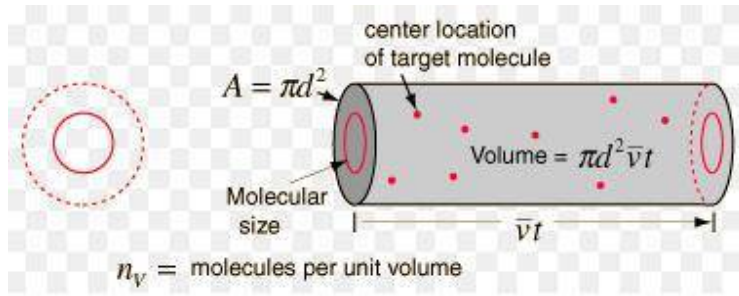

mean free path λ (the average distance travelled by a particle between collisions) to determine the best values for number of particles N , rms velocity V_{rms} , and box length L ;

$$\lambda = \frac{k_B T}{\sqrt{2} \pi d^2 p}$$

where d is the diameter of the particle and p is the pressure. which I can easily turn into:

$$\lambda = \frac{m v_{rms}^2}{2 \sqrt{2} \pi d^2 p}$$

The average distance a particle can travel before colliding with another particle.

$$\lambda = \frac{1}{n \sigma}$$

Effect of pressure: $\lambda \propto \frac{1}{p}$

Heat or Thermodynamics 10) Questions on efficiency of cycle

Suppose 0.2 mole of an ideal di-atomic gas ($\gamma = 1.4$) undergoes cycle with temperature $T_H = 400$ K and $T_C = 300$ K. The initial pressure is $p_a = 10 \times 10^5$ Pa and during isothermal expansion at temperature T_H the volume doubles.

- (i) Find Q , W and ΔU from each step in the cycle.
- (ii) Find the efficiency.

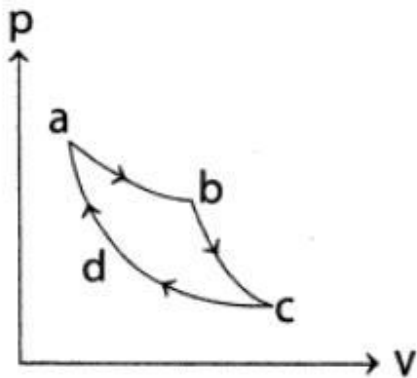

Solution

$$(i) \quad V_a = \frac{nRT_H}{p_a} \\ = \frac{0.2 \times 8.314 \times 400}{10 \times 10^5} = 6.65 \times 10^{-4} \text{ m}^3$$

For isothermal expansion $a \rightarrow b$

$$p_a V_a = p_b V_b$$

Newton 's Law of Cooling by Prof. Subhashish Chattopadhyay SKMClasses Bangalore Useful for IIT-JEE, CBSE, I.Sc. PU-II, Boards, CET, CEE, PET, IGCSE IB AP-Physics and other exams

$$\text{or } p_b = \frac{P_a V_a}{V_b} = 5 \times 10^5 p_a$$

For adiabatic expansion $b \rightarrow c$

$$T_H V_b^{\gamma-1} = T_c V_c^{\gamma-1}$$

$$\therefore V_c = V_b \left(\frac{T_H}{T_c} \right)^{\frac{1}{\gamma-1}}$$

$$= 13.3 \times 10^{-4} \times \left(\frac{4}{3} \right)^{2.5} = 27.3 \times 10^{-4} \text{ m}^3$$

$$p_c = \frac{nRT_c}{V_c} = \frac{0.2 \times 8.314 \times 300}{27.3 \times 10^{-4}}$$

$$= 1.83 \times 10^5 \text{ Pa}$$

For adiabatic compression $d \rightarrow a$

$$T_c V_d^{\gamma-1} = T_H V_a^{\gamma-1}$$

$$V_d = V_a \left(\frac{T_H}{T_c} \right)^{\frac{1}{\gamma-1}} = 6.65 \times 10^{-4} \times \left(\frac{4}{3} \right)^{2.5}$$

Newton 's Law of Cooling by Prof. Subhashish Chattopadhyay SKMClasses Bangalore Useful for IIT-JEE, CBSE, I.Sc. PU-II, Boards, CET, CEE, PET, IGCSE IB AP-Physics and other exams

Newton 's Law of Cooling by Prof. Subhashish Chattopadhyay SKMClasses Bangalore Useful for IIT-JEE, CBSE, I.Sc. PU-II, Boards, CET, CEE, PET, IGCSE IB AP-Physics and other exams

$$= 13.65 \times 10^{-4} \quad p_d = \frac{nRT_c}{V_d}$$
$$= \frac{0.2 \times 8.314 \times 300}{13.65 \times 10^{-4}} = 3.65 \times 10^5 \text{ Pa}$$

For isothermal expansion $a \rightarrow b$

$$\Delta U = 0$$

$$\therefore W = Q_H = nRT_H \cdot \log_e \frac{V_b}{V_a}$$
$$= 0.2 \times 8.314 \times 400 \log_e 2$$
$$= \mathbf{461 \text{ J}}$$

For adiabatic expansion $b \rightarrow c$

$$Q = 0$$

$$\therefore W = -\Delta U = nC_V(T_H - T_C)$$
$$= 0.2 \times 20.78 \times (400 - 300)$$
$$= \mathbf{415.7 \text{ J}}$$

For isothermal compression $c \rightarrow d$

$$\Delta U = 0$$

$$\therefore W = Q_c = nRT_c \log_e \frac{V_d}{V_c}$$
$$= 0.2 \times 8.314 \times 300 \log_e \frac{13.65 \times 10^{-4}}{27.3 \times 10^{-4}}$$
$$= \mathbf{-345.8 \text{ J}}$$

For adiabatic expansion $d \rightarrow a$

$$Q = 0$$

$$\therefore W = -U$$
$$= nC_V(T_C - T_H)$$
$$= 0.2 \times 20.78 \times (300 - 400)$$
$$= \mathbf{-415.7 \text{ J}}$$

Newton 's Law of Cooling by Prof. Subhashish Chattopadhyay SKMClasses Bangalore Useful for IIT-JEE, CBSE, I.Sc. PU-II, Boards, CET, CEE, PET, IGCSE IB AP-Physics and other exams

The results may be tabulated as follows:

	Q	W	ΔU
$a \rightarrow b$	461 J	461 J	0 J
$b \rightarrow c$	0 J	415.7 J	- 415.7 J
$c \rightarrow d$	- 345.8 J	- 345.8 J	0 J
$d \rightarrow a$	0 J	- 415.7 J	415.7 J
Total	115.2 J	115.2 J	0 J

(ii) For entire cycle, $Q = W$

$$\Delta U = 0$$

$$\text{Total work done} = 115.2 \text{ J}$$

$$Q_H = 461 \text{ J}$$

$$\therefore \eta = \frac{W}{Q_H} = \frac{115.2}{461} = \mathbf{0.25}$$

Efficiency of cycle example

One mole of a di-atomic ideal gas ($\gamma = 1.4$) is taken through a cyclic process starting from point A . The process $A \rightarrow B$ is an adiabatic compression, $B \rightarrow C$ isobaric expansion, $C \rightarrow D$ is an adiabatic expansion and $D \rightarrow A$ isochoric expansion. The volume ratios are $\frac{V_A}{V_B} = 16$ and $\frac{V_C}{V_B} = 2$ and the temperature at A is $T_A = 300$ K. Calculate the temperature of gas at the points B and D and find the efficiency of the cycle.

Solution For an ideal gas undergoing adiabatic expansion or compression, we have

$$TV^{\gamma-1} = \text{Constant}$$

For the expansion at constant pressure, we have

$$\frac{V}{T} = \text{Constant}$$

With this information, temperature of the gas at different stages of the cyclic process may be determined as follows:

(i) Adiabatic compression from A to B

$$T_B V_B^{\gamma-1} = T_A V_A^{\gamma-1}$$

$$\begin{aligned} \text{or } T_B &= \left(\frac{V_A}{V_B} \right)^{\gamma-1} T_A = (16)^{1.4-1} (300) \\ &= (3.03) (300 \text{ K}) = \mathbf{909 \text{ K}} \end{aligned}$$

(ii) Isobaric expansion from B to C

$$\frac{V_C}{T_C} = \frac{V_B}{T_B}$$

$$\text{or } T_C = \left(\frac{V_C}{V_B} \right) T_B = 2(909) = \mathbf{1818 \text{ K}}$$

(iii) Adiabatic expansion from C to D

$$T_D V_D^{\gamma-1} = T_C V_C^{\gamma-1}$$

$$\text{or } T_D = \left(\frac{V_C}{V_D} \right)^{\gamma-1} T_C$$

Since, $D \rightarrow A$ is isochoric process, therefore

$$V_D = V_A$$

Hence,

$$\begin{aligned}T_D &= \left(\frac{V_C}{V_D}\right)^{\gamma-1} T_C = \left(\frac{V_C}{16 V_B}\right)^{\gamma-1} T_C \\&= \left(\frac{2}{16}\right)^{1.4-1} (1818 \text{ K}) \\&= (0.4353) (1818 \text{ K}) = 791.4 \text{ K}\end{aligned}$$

The given cyclic process is show in the figure.

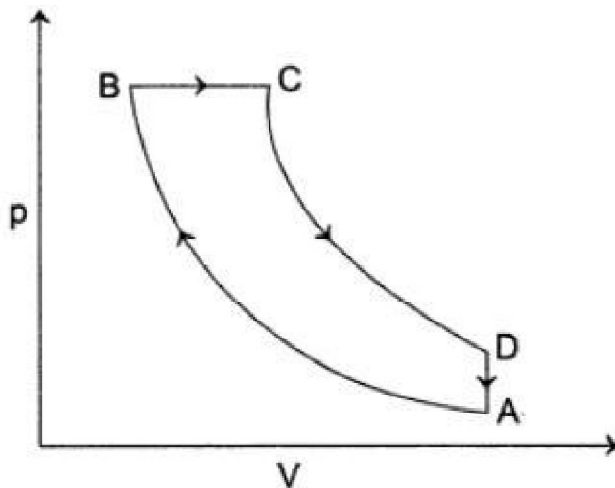

Efficiency of the cycle is defined as

$$\eta = \frac{\text{Work obtained in one cycle}}{\text{Heat absorbed in the process } B \rightarrow C}$$

Now, the work obtained in one cycle is equal to the area within the cycle ABCDA. This

work is given as

$$W = |W_{B \rightarrow C}| + |W_{C \rightarrow D}| + |W_{B \rightarrow A}|$$
$$= RT_B + C_V(T_C - T_D) - C_V(T_B - T_A)$$

For a di-atomic gas,

$$C_V = \frac{5}{2} \text{ and } C_P = \frac{7}{2} R.$$

Hence,

$$W = R \left[T_B + \frac{5}{2} (T_C - T_D - T_B - T_A) \right]$$
$$= (8.314 \text{ JK}^{-1} \text{ mol}^{-1})$$

$$\left[(909 \text{ K}) + \frac{5}{2} (1818 - 791.4 - 909 + 300) \text{ K} \right]$$

= 16237.2 Kelvin per mole

Heat absorbed in the process $B \rightarrow C$ is given as

$$Q = C_P (T_C - T_B)$$
$$= \left(\frac{7}{2} R \right) (T_C - T_B)$$
$$= \frac{7}{2} \times (8.314 \text{ JK}^{-1} \text{ mole}^{-1})$$
$$(1818 \text{ K} - 909 \text{ K})$$
$$= 26451.0 \text{ J mole}^{-1}$$

Hence, the efficiency of the cycle is

$$\eta = \frac{W}{Q} = \frac{16237.2}{26451.0} = \mathbf{0.614}$$

Example of Efficiency of a cycle

An ideal gas is taken through a cycle thermodynamic process through four steps. The amount of heat involved in these steps are $Q_1 = 5960 \text{ J}$, $Q_2 = - 5585 \text{ J}$,

$Q_3 = - 2980 \text{ J}$ and $Q_4 = 3645 \text{ J}$ respectively. The corresponding worked involved are $W_1 = 2200 \text{ J}$, $W_2 = - 825 \text{ J}$, $W_3 = - 1100 \text{ J}$ and W_4 respectively.

- (i) Find the value of W_4 .
- (ii) What is the efficiency of the cycle?

Solution For a cyclic process

$$\Delta U = 0$$

(i) Cyclic $\int dQ = \int dW$

$$\begin{aligned} \text{i.e., } Q_1 + Q_2 + Q_3 + Q_4 \\ = W_1 + W_2 + W_3 + W_4 \end{aligned}$$

$$\begin{aligned} \text{or } 5960 - 5585 - 2980 + 3645 \\ = 2200 - 825 - 1100 + W_4 \end{aligned}$$

$$\text{or } W_4 = 765 \text{ J}$$

- (ii) Efficiency of the cycle,

$$\eta = \frac{\text{Net work output}}{\text{Total heat input}}$$

$$\begin{aligned} \text{Net work output} &= 5960 - 5585 \\ &\quad - 2980 + 3645 \\ &= 1040 \text{ J} \end{aligned}$$

$$\begin{aligned} \text{Total heat input} &= Q_1 + Q_4 \\ &= 5960 + 3645 = 9605 \text{ J} \end{aligned}$$

$$\therefore \eta = \frac{1040}{9605} \times 100 = 10.83\%$$

Question on Cycle

2.00 mole of a mono-atomic ideal gas ($U = 1.5 nRT$) is enclosed in an adiabatic, vertical cylinder fitted with a smooth light adiabatic piston. The piston is connected to a vertical spring of spring constant 200 N/m as shown in the figure. The area of cross-section of the cylinder is 20.0 cm^2 . Initially, the spring is at its natural length and the temperature of the gas is 300 K . The atmospheric pressure is 100 kPa . The gas is heated slowly for some time by means of an electric heater so as to move the piston up through 10 cm . Find:

- (i) The work done by the gas.**
- (ii) The final temperature of the gas.**
- (iii) The heat supplied by the heater.**

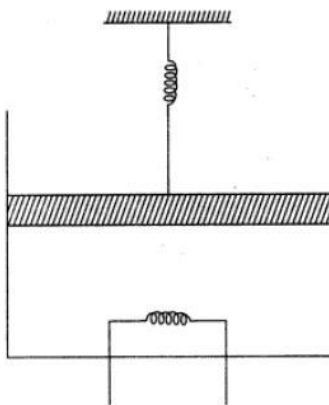

Solution

(i) Force by the gas on the piston is

$$F = p_0 A + kx$$

where, $P_0 = 100 \text{ kPa}$ is the atmospheric pressure.

$A = 20 \text{ cm}^2$ is the area of the cross-section,

$k = 200 \text{ N/m}$ is the spring constant, and

$x =$ the compression of spring.

Work done by the gas if the piston moves through $l = 10 \text{ cm}$ is

$$W = \int_0^l F dx$$

$$= P_0 A l + \frac{1}{2} k l^2$$

$$= (100 \times 10^3 \text{ Pa})$$

$$(20 \times 10^{-4} \text{ m}^2) \times (10 \times 10^{-2} \text{ m})$$

$$+ \frac{1}{2} (200 \text{ N/m}) (100 \times 10^{-4} \text{ m}^2)$$

$$= 20 + 1 \text{ J} = \mathbf{21 \text{ J}}$$

(ii) Initial temperature, $T_1 = 300 \text{ K}$. Let the final temperature by T_2 , then

$$nRT_1 = p_0 V_0$$

$$nRT = pV_2 = \left(p_0 + \frac{kl}{A} \right) (V_0 + Al)$$

$$= nRT_1 + p_0 Al + kl^2 + \frac{kl nRT_1}{AP_0}$$

$$\text{or } T_2 = T_1 + \frac{p_0 Al + kl^2}{nR} + \frac{k l T_1}{A P_0}$$

$$\begin{aligned} 300 + \frac{20 \text{ J} + 2 \text{ J}}{20 \times 8.3} + \frac{200 \times 10 \times 10^{-2} \times 300}{20 \times 10^{-4} \times 100 \times 10^3 \text{ Pa}} \\ = 300 \text{ K} + 1.325 \text{ K} + 30 \text{ K} \\ = \mathbf{331 \text{ K}} \end{aligned}$$

(iii) Internal energy, $U = 1.5 nRT$

$$\begin{aligned} \therefore \Delta U &= 1.5 nR\Delta T \\ &= 1.5 \times 2.00 \times 8.3 \times 31 \\ &= 772 \text{ J} \end{aligned}$$

From the first law,

$$\begin{aligned} \Delta Q &= \Delta U + \Delta W \\ &= (772 + 21) \text{ J} = \mathbf{793 \text{ J}} \end{aligned}$$

Example where 2 vessels are connected

Two vessels contain in each of them one mole of mono-atomic gas. The initial volume of each vessel is $8.3 \times 10^{-3} \text{ m}^3$. Equal amount of heat is supplied to each vessel. In one vessel, the volume of gas is doubled without change in its internal energy whereas the volume of the gas is held constant in second vessel. The vessels are now connected to allow free mixing. Find the final temperature and pressure of the combined system.

Solution According to the first law of thermodynamics,

$$\Delta Q = \Delta U + \Delta W$$

For the first vessel: $\Delta U = 0$, (Since, no change in temperature)

$$\Delta Q = \Delta W$$

$$Q = \int_{V_1}^{V_2} p dV$$

$$= \int_{V_1}^{V_2} nRT \frac{dV}{V} \quad (\text{since, } pV = nRT)$$

Since $V_2 = 2 V_1$, therefore

$$Q = nRT \log_e 2, \quad \dots(i)$$

For the second vessel: $\Delta W = 0$, (volume is constant)

$$Q = nC_v \Delta T = n \left(\frac{3}{2} R \right) \Delta T \quad \dots(ii)$$

Since, for mono-atomic gas $C_v = \frac{3R}{2}$

From equations (i) and (ii), we get

$$nRT \log_e 2 = n \left(\frac{3}{2} R \right) \Delta T$$

$$\text{or } \Delta T = \frac{2}{3} \times 300 \times 0.693 = 138.6 \text{ K}$$

It is the change in temperature of the second vessel.

Now, temperature of the gas in second vessel

$$= T + \Delta T$$

$$= 300 + 138.6 = 438.6 \text{ K}$$

Let after mixing T_f and p_f be the final tempera-

ture and pressure, therefore

$$\begin{aligned}T_f &= \frac{T + (T + \Delta T)}{2} \\ &= \frac{300 + 438.6}{2} = 369.3 \text{ K}\end{aligned}$$

From the gas equation,

$$\begin{aligned}p_f V_f &= nRT_f \\ p_f &= \frac{nRT_f}{V_f} \\ &= \frac{2 \times 8.3 \times 369.3}{2 \times 8.3 \times 10^3 + 8.3 \times 10^{-3}} \\ &= 2.46 \times 10^5 \text{ N/m}^2\end{aligned}$$

A sample of 2 kg of mono-atomic Helium (assumed ideal) is taken through the process ABC and another sample of 2 kg of the same gas is taken through the process ADC. Given relative molecular weight of Helium = 4.

- (i) **What is the temperature of Helium in each of the states A, B, C and D?**
- (ii) **Is there any way of telling afterwards which sample of Helium went through the process ABC and which went through the process ADC? Write yes or no.**
- (iii) **How much heat is evolved in each of the processes ABC and ADC?**

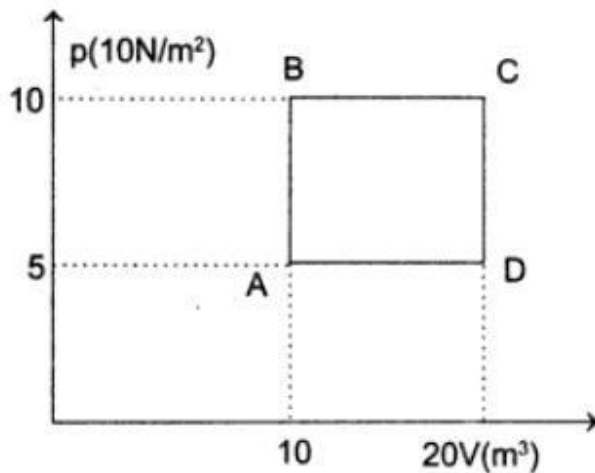

Solution

Amount of helium

$$= \frac{m}{M} = \frac{2 \times 10^3}{4 \text{ g mol}^{-1}} = 500 \text{ mole}$$

- (i) The temperature of gas at the states A, B, C and D are

$$\begin{aligned} T_A &= \frac{pV}{nR} \\ &= \frac{(5 \times 10^4 \text{ N/m}^2)(10 \text{ m}^3)}{(500 \text{ mole})(8.314 \text{ JK}^{-1} \text{ mole}^{-1})} \\ &= \mathbf{120.28 \text{ K}} \end{aligned}$$

$$\begin{aligned} T_B &= \frac{(10 \times 10^4 \text{ N/m}^2)(10 \text{ m}^3)}{(500 \text{ mole})(8.314 \text{ JK}^{-1} \text{ mole}^{-1})} \\ &= \mathbf{240.56 \text{ K}} \end{aligned}$$

$$T_c = \frac{(10 \times 10^4 \text{ N/m}^2)(10 \text{ m}^3)}{(500 \text{ mole})(8.314 \text{ JK}^{-1} \text{ mole}^{-1})}$$
$$= 481.12 \text{ K}$$

$$T_D = \frac{(5 \times 10^4 \text{ N/m}^2)(20 \text{ m}^3)}{(500 \text{ mole})(8.314 \text{ JK}^{-1} \text{ mole}^{-1})}$$
$$= 240.50 \text{ K}$$

(ii) No.

(iii) For the process ABC, we have

$$Q_{AB} = nC_V \Delta T$$
$$= (500 \text{ mole}) \left(\frac{3}{2} \times 8.314 \text{ JK}^{-1} \text{ mole}^{-1} \right)$$
$$(240.56 \text{ K} - 120.28 \text{ K})$$
$$= 7.5 \times 10^5 \text{ J}$$

$$Q_{BC} = nC_P \Delta T$$
$$= (500 \text{ mole}) \left(\frac{5}{2} \times 8.314 \text{ JK}^{-1} \text{ mole}^{-1} \right)$$
$$(481.12 \text{ K} - 240.56 \text{ K})$$
$$= 2.5 \times 10^6 \text{ J}$$

$$Q_{ABC} = Q_{AB} + Q_{BC}$$
$$= (7.5 \times 10^5 \text{ J} + 2.5 \times 10^6 \text{ J}) = 3.25 \times 10^6 \text{ J}$$

For the process ADC, we have

$$Q_{AD} = nC_P \Delta T$$
$$= (500 \text{ mole}) \left(\frac{5}{2} \times 8.314 \text{ JK}^{-1} \text{ mole}^{-1} \right)$$
$$(240.56 \text{ K} - 120.28 \text{ K})$$

$$= 1.25 \times 10^6 \text{ J}$$

$$Q_{DC} = nC_V \Delta T$$

$$= (500 \text{ mole}) \left(\frac{3}{2} \times 8.314 \text{ JK}^{-1} \text{ mole}^{-1} \right) \\ (481.12 \text{ K} - 240.56 \text{ K})$$

$$= 1.5 \times 10^6 \text{ J}$$

$$Q_{ADC} = Q_{AD} + Q_{DC}$$

$$= (1.25 \times 10^6 \text{ J} + 1.5 \times 10^6 \text{ J})$$

$$= 2.75 \times 10^6 \text{ J}$$

More example in Heat and Thermodynamics

A 1.00 mole sample of an ideal mono-atomic gas originally at a pressure of 1.00 atmosphere undergoes a three-step process:

- (i) **It is expanded adiabatically from $T_1 = 550 \text{ K}$ and $T_2 = 389 \text{ K}$.**
- (ii) **It is compressed at constant pressure until its temperature reaches T_3 .**
- (iii) **It then returns to its original pressure and temperature by a constant-volume process.**
 - (a) Plot these processes on a p - V diagram.
 - (b) Determine T_3 .
 - (c) Calculate the change in integral

energy the workdone by the gas,
and heat added to gas for each process.

(d) For the complete cycle.

Solution *First step Adiabatic Expansion*

$$Q_1 = 0$$

$$\begin{aligned}W_1 &= n_1 C_v (T_2 - T_1) \\&= (1.00 \text{ mol}) \left(\frac{3}{2} \times 8.314 \text{ JK}^{-1} \text{ mole}^{-1} \right) \\&\quad \times (389 \text{ K} - 550 \text{ K}) \\&= -2007.8 \text{ J}\end{aligned}$$

For adiabatic expansion of an ideal gas

$$p_2 T_2^{(-C_p/R)_g} = p_1 T_1^{(-C_p/R)_g}$$

$$\begin{aligned}\text{Hence, } p_2 &= p_1 \left(\frac{T_1}{T_2} \right)^{\frac{C_p}{R}} = (1.00 \text{ atm}) \left(\frac{389}{550} \right)^{\frac{5}{2}} \\&= 0.421 \text{ atm.}\end{aligned}$$

$$\begin{aligned}V_2 &= \frac{nRT_2}{p_2} \\&= \frac{(1.0 \text{ mole})(8.314 \text{ JK}^{-1} \text{ mole}^{-1})(550 \text{ K})}{(1.0 \times 101.325 \text{ KPa})} \\&= 45.1 \text{ dm}^3\end{aligned}$$

$$\Delta U_1 = W_1 = -2007.8 \text{ J}$$

Second step compression at constant pressure:

The final volume in this process will be V_1 as in the third step, the system returns to the original state by constant volume process. Hence, in the second step,

$$T_2 = (389 \text{ K}) \text{ changes to } T_3$$

$$V_2 = (75.8 \text{ dm}^3) \text{ changes to } V_1 \\ = 45.1 \text{ dm}^3$$

$$p_2 = \text{remains constant.}$$

Workdone in the process

$$W_2 = -p_2 (V_1 - V_2) \\ = -(0.421 \times 101.325 \text{ kPa}) (45.1 \text{ dm}^3 - 75.8 \text{ dm}^3) \\ = 1309.6 \text{ J}$$

$$T_3 = \left(\frac{V_1}{V_2} \right) T_2 = \left(\frac{45.1}{75.8} \right) (389 \text{ K}) = 231.4 \text{ K}$$

$$Q_2 = n C_p (T_3 - T_2)$$

$$= \left(\frac{5}{2} \times 8.314 \text{ JK}^{-1} \right) (231.4 \text{ K} - 389 \text{ K})$$

$$= -3275.7 \text{ J}$$

$$\Delta U_2 = Q_2 + W_2$$

$$= -3275.7 \text{ J} + 1309.6 \text{ J} = -1966.1 \text{ J}$$

Third step compression at constant volume in this process:

$$W_3 = 0$$

$$V_1 = (45.1 \text{ dm}^3) \text{ remains constant}$$

$$Q_3 = n C_v (T_1 - T_3)$$

Newton 's Law of Cooling by Prof. Subhashish Chattopadhyay SKMClasses Bangalore Useful for IIT-JEE, CBSE, I.Sc. PU-II, Boards, CET, CEE, PET, IGCSE IB AP-Physics and other exams

$$= \left(\frac{3}{2} \times 8.314 \text{ JK}^{-1} \right) (550 \text{ K} - 231.4 \text{ K})$$

$$\Delta U = 3973.3 \text{ J}$$

Since, the system return to its original state, we will have

$$\Delta U = Q + W = 0$$

$$\begin{aligned} \text{Now, } W &= W_1 + W_2 + W_3 \\ &= -2007.8 \text{ J} + 1309.6 \text{ J} + 0 \\ &= -698.2 \text{ J} \end{aligned}$$

$$\therefore Q = -W = 698.6 \text{ J}$$

The p - V plot of the given process is shown in the figure:

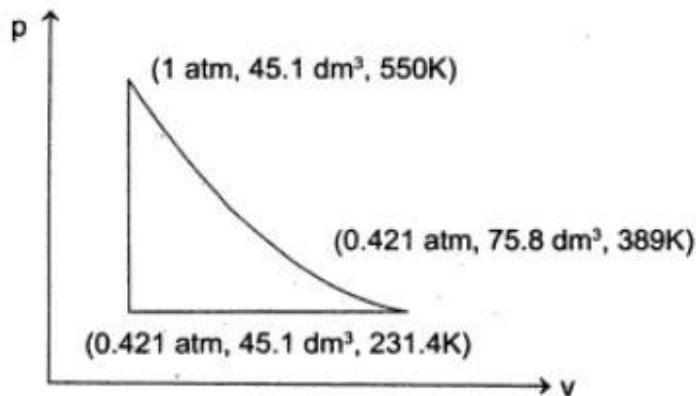

In the complete cycle

$$\Delta U = 0$$

$$\begin{aligned} Q &= Q_1 + Q_2 + Q_3 \\ &= 0 - 3275.7 \text{ J} + 3973.3 \text{ J} = 697.6 \text{ J} \end{aligned}$$

$$\begin{aligned} W &= -Q = 697.6 \text{ J} (= W_1 + W_2 + W_3) \\ &= -2007.8 + 1309.6 \text{ J} + 0 = 698.2 \text{ J} \end{aligned}$$

Newton 's Law of Cooling by Prof. Subhashish Chattopadhyay SKMClasses Bangalore Useful for IIT-JEE, CBSE, I.Sc. PU-II, Boards, CET, CEE, PET, IGCSE IB AP-Physics and other exams

Two mole of an ideal mono-atomic gas is taken through a cycle $ABCA$ as shown in the $p - T$ diagram. During this process AB , pressure and temperature of the gas vary such that $pT = \text{constant}$. If $T_1 = 300$ K, calculate:

- (i) **The work done on the gas in the process AB .**
- (ii) **The heat absorbed or released by the gas in each of the process.**

Give answers in terms of the gas constant R .

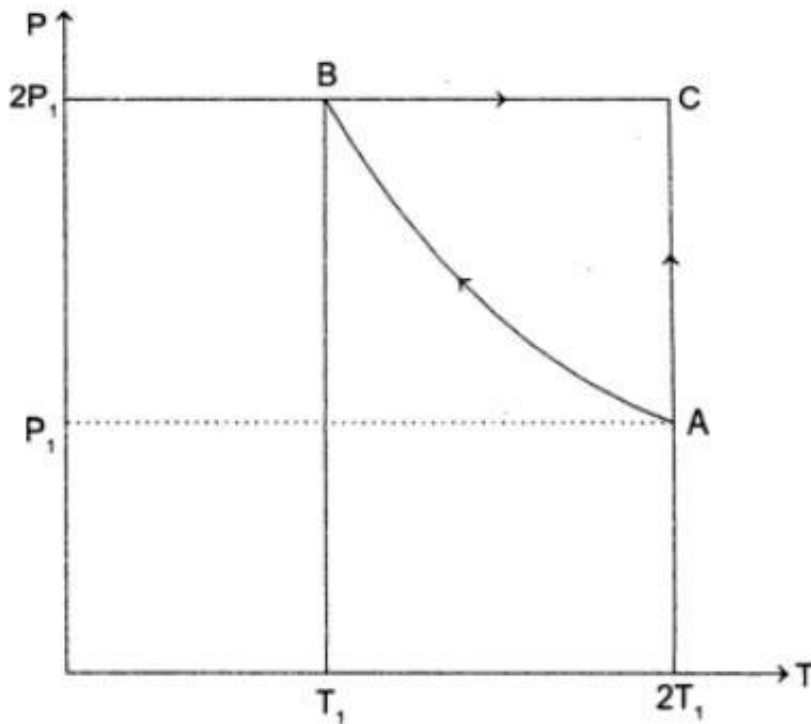

Solution The volumes of the gas at three states A, B and C are as follows:

$$V_A = \frac{nRT_A}{P_A} = \frac{nR(2T_1)}{P_1} = \frac{2nRT_1}{P_1} \dots(i)$$

$$V_B = \frac{nRT_B}{P_B} = \frac{nR(2T_1)}{P_1} = \frac{1}{2} \frac{nRT_1}{P_1} \dots(ii)$$

$$V_C = \frac{nRT_C}{P_C} = \frac{nR(2T_1)}{2P_1} = \frac{nRT_1}{P_1} \dots(iii)$$

It is given that during the process AB,

$$pT = K \dots(iv)$$

where, K is constant and is given as

$$K = p_A T_A = (p_1) (2T_1) = 2 p_1 T_1 \dots(v)$$

In the process AB, we will have

$$= \sqrt{nRK} \left[2\sqrt{V_B} - 2\sqrt{V_A} \right]$$

Using equations (i), (ii) and (v), we get

$$\begin{aligned} W_{AB} &= \sqrt{nR(2p_1T_1)} \left[2\sqrt{\frac{nRT_1}{2p_1}} - 2\sqrt{\frac{2nRT_1}{p_1}} \right] \\ &= (\sqrt{2} nRT_1)(2) \left[\frac{1}{2} - \sqrt{2} \right] \\ &= -2n T_1 R \\ &= -2 (2 \text{ mole}) (200 \text{ K}) R \\ &= - (1200 \text{ mole K}) R \end{aligned}$$

The negative sign implies that the work is done on the gas.

Hence, work done on the gas
= **(1200 mole K) R**

(ii) Change in energy of the gas in the process AB is

$$\begin{aligned}\Delta U_{AB} &= nC_v \Delta T \\ &= (2 \text{ mole}) \left(\frac{3}{2} R \right) (T_1 - 2 T_1) \\ &= - (3 \text{ mole}) T_1 R \\ &= - (3 \text{ mole}) (300 \text{ K}) R \\ &= - (900 \text{ mole K}) R\end{aligned}$$

Now, from the first law of thermodynamics,

$$\begin{aligned}Q_{AB} &= \Delta U_{AB} + W_{AB} \\ &= - (1200 \text{ mole K}) R \\ &= - (900 \text{ mole K}) R \\ &= - (2100 \text{ mole K}) R\end{aligned}$$

The negative sign implies that the heat is released in the process AB. The process

BC takes place at constant pressure.

Hence,

$$\begin{aligned}W_{BC} &= p V \\ &= (2 p_1) (V_C - V_B) \\ &= (2 p_1) \left[\frac{nRT_1}{P_1} - \frac{nRT_1}{2 P_1} \right] \\ &= nRT_1 \\ &= (2 \text{ mole}) (300 \text{ K}) R \\ &= (600 \text{ mole K}) R\end{aligned}$$

Now, $\Delta U_{BC} = nC_v \Delta T$

$$= (2 \text{ mole}) \left(\frac{3}{2} R \right) (T_C - T_B)$$

$$\begin{aligned} &= (3 \text{ mole}) (R) (2 T_1 - T_1) \\ &= (3 \text{ mole}) (R) (300 \text{ K}) \\ &= (900 \text{ mole K}) R \\ Q_{BC} &= \Delta U_{BC} + W_{BC} \\ &= (900 \text{ mole K}) R + (600 \text{ mole K}) \\ &\quad R \\ &= \mathbf{(1500 \text{ mole K}) R} \end{aligned}$$

The positive sign implies that the heat is absorbed in the process BC.

The process CA takes place at constant temperature. Hence,

$$\begin{aligned} W_{CA} &= \int_{V_A}^{V_B} p dV \\ &= \int_{V_A}^{V_B} \frac{nRT}{V} dV \\ &= nRT \ln \frac{V_A}{V_C} \dots (\text{where, } T = 2 T_1) \\ &= (2 \text{ mole}) (R) (2 \times 300 \text{ K}) \ln 2 \\ &= (1200 \text{ mole K}) R \ln 2 \end{aligned}$$

$$\begin{aligned} \Delta U_{CA} &= 0 \\ Q_{CA} &= \Delta U_{CA} + W_{CA} \\ &= 0 + (1200 \text{ mole K}) R \ln 2 \end{aligned}$$

The positive sign implies that the heat is absorbed in the process CA.

An ideal mono-atomic is confined in a cylinder by a spring-loaded piston of cross-section $8 \times 10^{-3} \text{ m}^2$. Initially, the gas is at 300 K and occupies a volume of $2.4 \times 10^{-3} \text{ m}^3$ and the spring is on its relaxed (unstretched, uncompressed) state as shown the figure. The gas is heated by a small electric heater until the piston moves out slowly by 0.1 m. Calculate the final temperature of the gas and the heat supplied (in joules) by the heater. The force constant of the spring is 8000 Nm^{-1} and atmospheric pressure is $1 \times 10^5 \text{ Nm}^2$. The cylinder and the piston are thermally insulated. The piston is massless and there is no friction between the piston and cylinder. Neglect heat loss through the lead wires of the heater. The heat capacity of the heater coil is negligible. [Assume the spring to be massless].

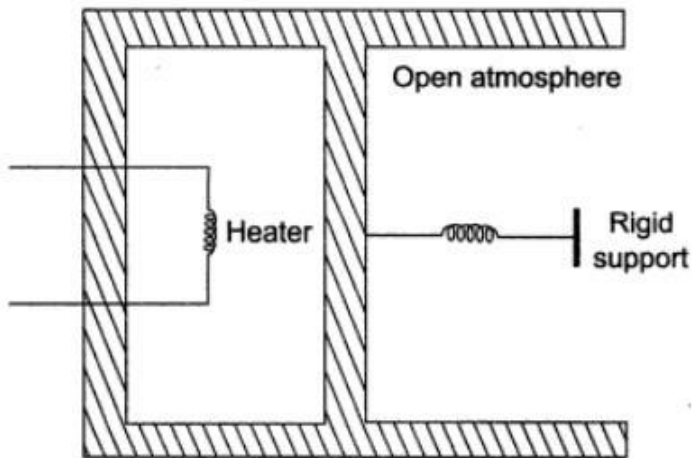

Solution Let p_0 be the atmospheric pressure. Initially for the equilibrium of the piston, $p_L = p_R = p_0$ where p_L and p_R are the pressures on the left hand and right hand side of the piston.

Force exerted by the spring on the piston when it moves

$$F = kx = 8000 \times 0.1 \\ = 800 \text{ N}$$

\therefore Pressure exerted on the piston by the spring

$$p_s = \frac{F}{A} = \frac{800 \text{ N}}{8 \times 10^{-3} \text{ m}^2} = 1 \times 10^5 \text{ Nm}^{-2}$$

\therefore Total pressure acting on the right hand side

$$p'_R = p_0 + p_s \\ = 2 \times 10^5 \text{ N/m}^2$$

Under equilibrium $p'_L = p'_R$

Newton 's Law of Cooling by Prof. Subhashish Chattopadhyay SKMClasses Bangalore Useful for IIT-JEE, CBSE, I.Sc. PU-II, Boards, CET, CEE, PET, IGCSE IB AP-Physics and other exams

$$\text{or } \frac{p_L V_L}{T_L} = \frac{p'_L V'_L}{T'_L}$$

$$= \frac{1 \times 10^5 \times 2.4 \times 10^{-3}}{300}$$

$$= \frac{2 \times 10^5 \times 3.2 \times 10^{-3}}{T'_L}$$

$$T'_L = 800 \text{ K}$$

$$\Delta U = n C_v \Delta T$$

$$\text{where, } n = \frac{p_L V_L}{R T_L} = \frac{1 \times 10^5 \times 2.4 \times 10^{-3}}{8.3 \times 300}$$

$$= 0.09638 \text{ mole}$$

$$\therefore \Delta U = 0.09638 \times \frac{3}{2} \times 8.3 \times (800 - 300) = 600 \text{ J}$$

$$\Delta W = \frac{1}{2} k \cdot x^2 + p_0 \cdot \Delta V$$

$$= \frac{1}{2} \times 800 \times (0.1)^2 + 1 \times 10^5 \times 8 \times 10^{-4}$$

$$= 120 \text{ J}$$

$$\Delta Q = \Delta U + \Delta W = 600 + 120 = \mathbf{720 \text{ J.}}$$

Newton 's Law of Cooling by Prof. Subhashish Chattopadhyay SKMClasses Bangalore Useful for IIT-JEE, CBSE, I.Sc. PU-II, Boards, CET, CEE, PET, IGCSE IB AP-Physics and other exams

A system is taken from state i to the state f (refer to the figure). Along path “ iaf ”, it is found that $\Delta Q = 50$ cal. $\Delta W = 20$ cal. Along the path “ ibf ”, $\Delta Q = 36$ cal. Calculate:

- (i) ΔW along the path “ ibf ”.
- (ii) If $\Delta W = -13$ cal for the curved path “ fi ”, what is the ΔQ for this path?
- (iii) Taking $U_i = 10$ cal, what is U_f ?
- (iv) If $U_b = 22$ cal, what is ΔQ for the process “ ib ” and the process “ bf ”?

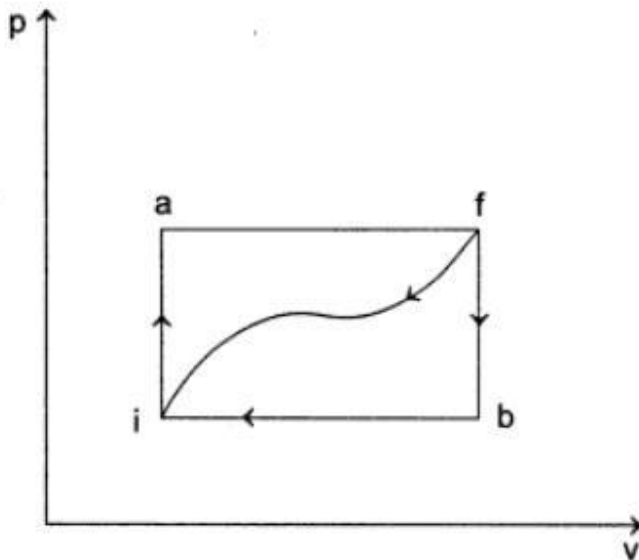

Solution Path "iaf" $\Delta Q = 50 \text{ cal}$

$$\Delta W = 20 \text{ cal}$$

$$\Rightarrow \Delta U = \Delta Q - \Delta W \\ = 50 - 20 = 30 \text{ cal}$$

$$\Rightarrow U_f - U_i = 30 \text{ cal}$$

As internal energy change is a state function.

ΔU will be same for any path from i to f .

$$\begin{aligned} \text{(i) Path "ibf"} \Delta W &= \Delta Q - \Delta U \\ &= 36 - (U_f - U_i) \\ &= 36 - 30 = \mathbf{6 \text{ cal.}} \end{aligned}$$

$$\begin{aligned} \text{(ii) Path "fi"} \Delta Q &= \Delta U + \Delta W \\ &= (U_f - U_i) + \Delta W \\ &= (-30) + (-13) \\ &= \mathbf{-43 \text{ cal}} \end{aligned}$$

$$\begin{aligned} \text{(iii) } U_f - U_i &= 30 \text{ cal} \\ U_f &= U_i + 30 \quad \therefore = \mathbf{40 \text{ cal.}} \end{aligned}$$

$$\begin{aligned} \text{(iv) Process "ib"} \Delta Q &= \Delta U + \Delta W \\ &= (U_b - U_i) + (\Delta W)_{ibf} \\ (\Delta W)_{ib} &= (\Delta W)_{ibf} \end{aligned}$$

Because $(\Delta W)_{bf} = 0$

$$\begin{aligned} \Delta Q &= (22 - 10) + 6 \\ &= \mathbf{18 \text{ cal.}} \end{aligned}$$

$$\begin{aligned} \text{Process "bf"} \Delta Q &= \Delta U + \Delta W \\ &= (U_f - U_b) + 0 \\ &= (40 - 22) \\ &= \mathbf{18 \text{ cal.}} \end{aligned}$$

A mono-atomic ideal gas of two moles is taken through a cyclic process starting from A as shown in the figure. The

volume ratios are $\frac{V_B}{V_A} = 2$ and $\frac{V_D}{V_A} = 4$.

If the temperature T_A at A is 27°C , calculate:

- (i) **The temperature of the gas at point B .**
- (ii) **Heat absorbed or released by the gas in each process.**
- (iii) **The total work done by the gas during complete cycle.**

Express your answer in terms of the gas constant R .

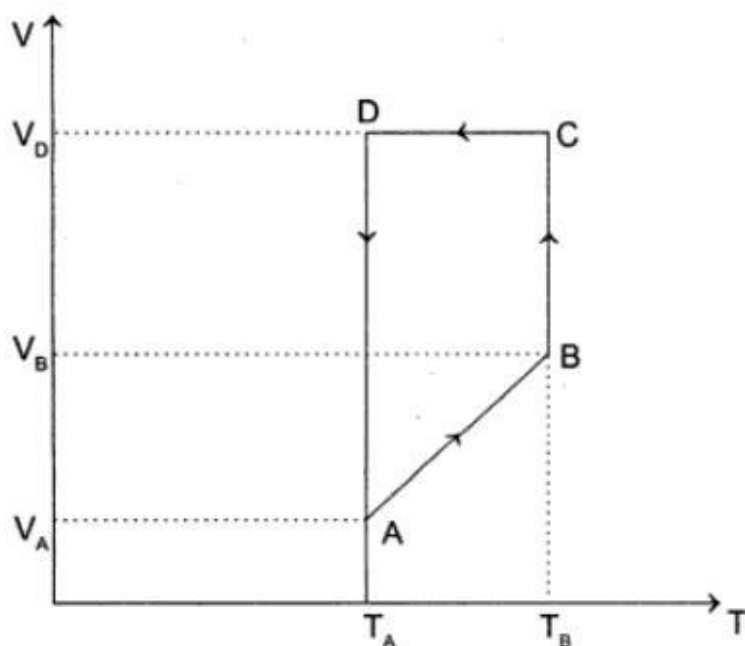

Solution

Given: $\frac{V_B}{V_A} = 2$ and $\frac{V_D}{V_A} = 4$

$$T_A = 27^\circ\text{C}$$

- (i) The process $A \rightarrow B$ in which the plot of V verse T is linear occurs at constant pressure condition.

$$\text{Hence } \frac{V_A}{T_A} = \frac{V_B}{T_A}$$

$$\text{or } T_B = \left(\frac{V_B}{T_A} \right) T_A = (2)(300 \text{ K}) \\ = \mathbf{600 \text{ K}}$$

- (ii) The process $A \rightarrow B$ occurs at constant pressure. Hence,

$$Q_{A \rightarrow B} = n C_p (T_B - T_A) \\ = (2 \text{ mole}) \left(\frac{5}{2} R \right) (600 \text{ K} - 300 \text{ K}) \\ = (1500 \text{ mole K}) R.$$

The process $B \rightarrow C$ occurs at constant temperature. From first law of thermodynamics

$$dU = dQ - dW$$

Since, the internal energy of an ideal gas depends only on temperature, therefore

$$dU = 0 \text{ and } dQ = dW$$

$$Q_{B \rightarrow C} = W_{B \rightarrow C}$$

$$= \int p dV = nRT_B \int \frac{dV}{V}$$

$$= nR T_B \ln \frac{V_C}{V_B}$$

$$= nR T_B \ln \frac{V_D}{V_B} \dots \dots (\text{as } V_C = V_D)$$

$$\begin{aligned}
 &= nR T_B \ln\left(\frac{V_D}{V_A} \frac{V_A}{V_B}\right) \\
 &= (2 \text{ mole}) (R) (600 \text{ K}) \ln\left(\frac{4}{2}\right) \\
 &= (1200 \text{ mole K}) R \ln 2
 \end{aligned}$$

The process C \rightarrow D occurs at constant volume. Hence,

$$\begin{aligned}
 Q_{C \rightarrow D} &= nC_v (T_A - T_B) \\
 &= (2 \text{ mole}) \left(\frac{3}{2}R\right) (300 \text{ K} - 600 \text{ K}) \\
 &= - (900 \text{ mole K}) R
 \end{aligned}$$

The process D \rightarrow A occurs at constant temperature. Hence,

$$\begin{aligned}
 Q_{D \rightarrow A} &= W_{D \rightarrow A} = nRT_A \ln \frac{V_A}{V_D} \\
 &= (2 \text{ mole}) (R) (300 \text{ K}) \ln\left(\frac{1}{4}\right) \\
 &= - (1200 \text{ mole K}) R \ln 2.
 \end{aligned}$$

(iii) Since, the process ABCDA is a cyclic process, therefore

$$U = 0, W = Q$$

where,

$$\begin{aligned}
 Q &= Q_{A \rightarrow B} + Q_{B \rightarrow C} + Q_{C \rightarrow D} + Q_{D \rightarrow A} \\
 &= (1500 \text{ mole K}) R + (1200 \text{ mole K}) R \ln 2 - (900 \text{ mole K}) \\
 &\quad R - (1200 \text{ mole K}) R \ln 2 \\
 &= (600 \text{ mole K}) R.
 \end{aligned}$$

An ideal gas expands from a volume $V_0 = 1$ litre and pressure $p_0 = 1$ bar to volume 3 litre along two different paths ABC and AC as shown in figure. The heat added to the gas along the path ABC is 600 J.

- (i) Sketch the process on $p - T$ diagram.
- (ii) Find the work done by the gas along the paths ABC and AC .
- (iii) Find the heat transfer in the process along the path AC .

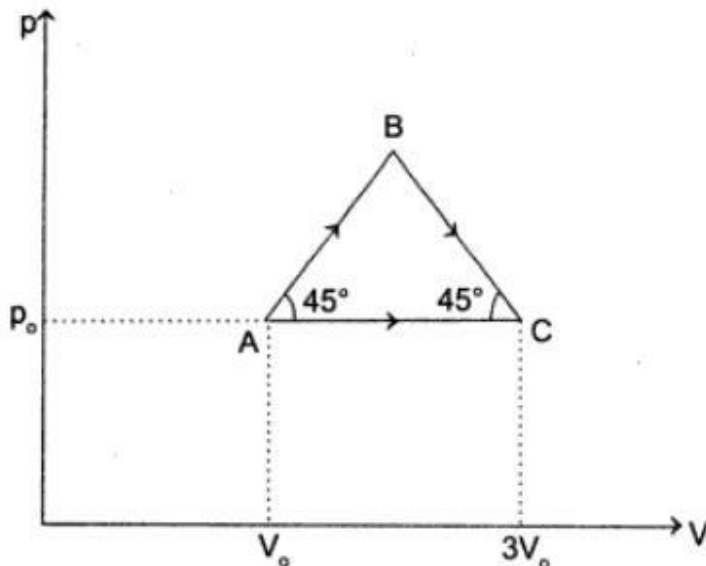

Solution

- (i) Equation of line AB,

$$p - p_0 = \tan 45^\circ (V - V_0)$$

Hence for ideal gas, $p = V$

Now $pV = KT$

$$\Rightarrow p^2 = KT \text{ (parabola)}$$

.....(where K is constant.)

At B $V_B = 2 V_0$ and $p_B = 2 p_0$
Equation of line BC, $p - 2 p_0 = -\tan 45^\circ$
($V - 2 V_0$)

$$\therefore p = -V + 4$$

$$\Rightarrow p = -\frac{KT}{P} + 4$$

$$\therefore P^2 - 4p = -KT \text{ (Parabola)}$$

(ii) Workdone along path AC = $(\Delta W)_{AC}$
 $= p_0 (3 V_0 - V_0)$
 $= 2 p_0 V_0$
 $= 2 \times 1 \times 10^5 \times 1 \times 10^{-3}$
 $= \mathbf{200 \text{ J.}}$

(iii) For path ABC $(\Delta Q)_{ABC} = (\Delta U)_{AC} +$
 $(\Delta W)_{ABC}$
 $\Rightarrow (\Delta U)_{AC} = 600 - 300$
 $= 300 \text{ J.}$

Heat transfer in the process along path AC,

$$(Q)_{AC} = (\Delta U)_{AC} + (\Delta W)_{AC}$$
$$= 300 + 200 = \mathbf{500 \text{ J.}}$$

Newton's Law of Cooling by Prof. Subhashish Chattopadhyay SKMClasses Bangalore Useful for IIT-JEE, CBSE, I.Sc. PU-II, Boards, CET, CEE, PET, IGCSE IB AP-Physics and other exams

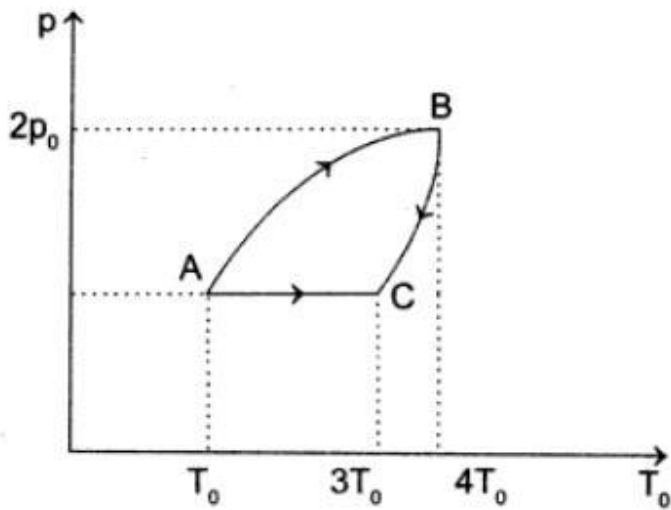
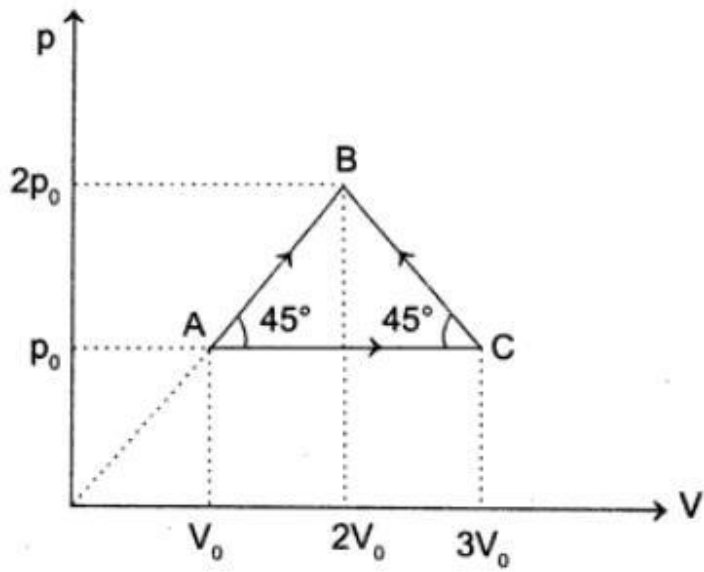

Newton's Law of Cooling by Prof. Subhashish Chattopadhyay SKMClasses Bangalore Useful for IIT-JEE, CBSE, I.Sc. PU-II, Boards, CET, CEE, PET, IGCSE IB AP-Physics and other exams

A monatomic ideal gas, initially at temperature T_1 is enclosed in a cylinder fitted with a frictionless piston. The gas is allowed to expand adiabatically to a temperature T_2 by releasing the piston suddenly. If L_1 and L_2 are the lengths of the gas column before and after expansion respectively, then T_1/T_2 is given by

(a) $\left(\frac{L_1}{L_2}\right)^{2/3}$

(b) $\frac{L_1}{L_2}$

(c) $\frac{L_2}{L_1}$

(d) $\left(\frac{L_2}{L_1}\right)^{2/3}$

$$TV^{\gamma-1} = \text{constant}$$

For monatomic gas $\gamma = \frac{5}{3}$

$$\Rightarrow TV^{2/3} = \text{constant}$$

Since volume is proportional to length, therefore,

$$\frac{T_1}{T_2} = \left(\frac{L_2}{L_1}\right)^{2/3}$$

Hence (d) is correct.

Two identical containers A and B with frictionless pistons contain the same ideal gas at the same temperature and the same volume V . The mass of gas contained in A is m_A and that in B is m_B . The gas in each cylinder is now allowed to expand isothermally to the same final volume $2V$. The change in the pressure in A and B are found to be Δp and $1.5 \Delta p$ respectively. Then

- (a) $4m_A = 9m_B$ (b) $2m_A = 3m_B$
(c) $3m_A = 2m_B$ (d) $9m_A = 4m_B$

$$\text{For gas in A, } p_1 = \left(\frac{m_A}{M}\right) \frac{RT}{V_1}$$

$$p_2 = \left(\frac{m_A}{M}\right) \frac{RT}{V_2}$$

$$\therefore \Delta p = p_2 - p_1 = \left(\frac{RT}{M}\right) m_A \left(\frac{1}{V_1} - \frac{1}{V_2}\right)$$

Putting $V_1 = V$ and $V_2 = 2V$, we get

$$\Delta p = \left(\frac{RT}{M}\right) \frac{m_A}{2V}$$

$$\text{Similarly for Gas in B, } 1.5 \Delta p = \left(\frac{RT}{M}\right) \frac{m_B}{2V}$$

From equation (i) and (ii) we get

$$2m_B = 3m_A$$

Hence (c) is the correct.

Two insulating cylinders A and B fitted with pistons contain equal amounts of an ideal diatomic gas at temperature 300 K . The piston A is free to move, while that of B is held fixed. The same amount of heat is given to the gas in each cylinder. If the rise in temperature of the gas in A is 30 K . Then the rise in temperature of the gas in B is

- (a) 30 K (b) 18 K
(c) 50 K (d) 42 K

For cylinder A For cylinder B

$$dQ = n C_p dT_1 \quad dQ = n C_V dT_2$$
$$= n (C_V + R) dT_1$$

$$\therefore n C_V dT_2 = n (C_V + R) 30$$

$$\therefore dT_2 = \frac{(C_V + R) 30}{C_V}$$

For diatomic gas $C_V = \frac{5}{2}R$

$$\therefore dT_2 = 42\text{ K}$$

Hence (d) is correct.

Which of the following graph correctly represents the variation of

$$\hat{a} = -\left(\frac{dV}{dP}\right)/V \text{ with } p \text{ for an ideal gas}$$

at constant temperature?

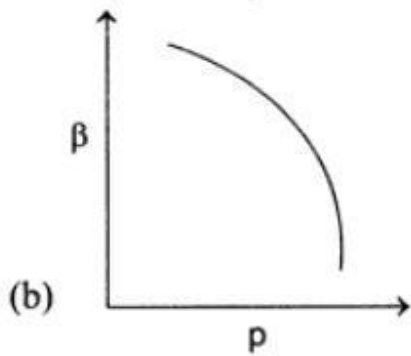
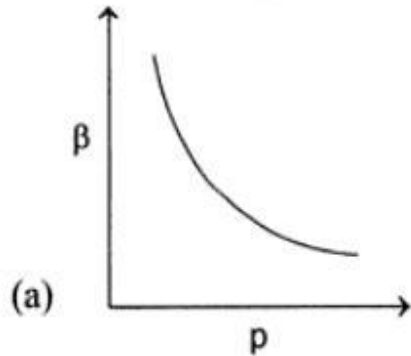

Newton 's Law of Cooling by Prof. Subhashish Chattopadhyay SKMClasses Bangalore Useful for IIT-JEE, CBSE, I.Sc. PU-II, Boards, CET, CEE, PET, IGCSE IB AP-Physics and other exams

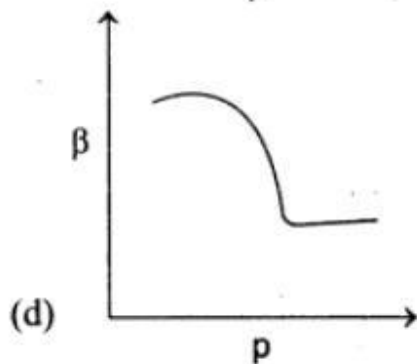
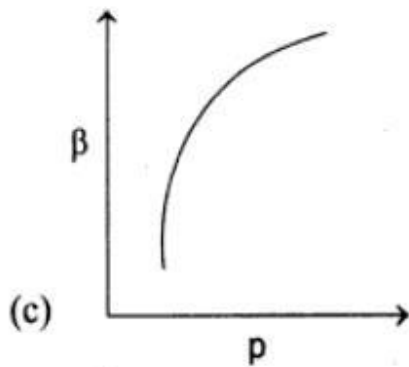

As temperature is constant,

$$pV = \text{constant}$$

$$\Rightarrow pdV + Vdp = 0$$

$$\Rightarrow -\frac{(dV/dp)}{V} = \frac{1}{p}$$

$$\Rightarrow \beta = \frac{1}{p}$$

Newton 's Law of Cooling by Prof. Subhashish Chattopadhyay SKMClasses Bangalore Useful for IIT-JEE, CBSE, I.Sc. PU-II, Boards, CET, CEE, PET, IGCSE IB AP-Physics and other exams

An ideal gas is taken through the cycle $A \rightarrow B \rightarrow C \rightarrow A$, as shown in the gas in the cycle is 5J, the work done by the gas in the process $C \rightarrow A$ is

- (a) $-5J$ (b) $-10J$
(c) $-15J$ (d) $-20J$

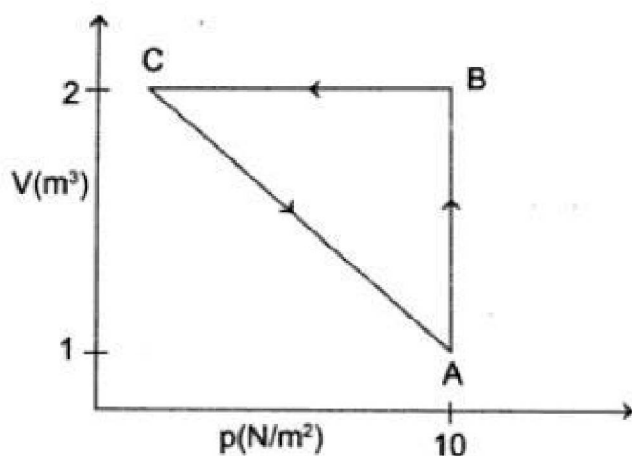

For the cyclic process $\Delta U = 0$

$$\begin{aligned}\Delta W &= W_{AB} + W_{BC} + W_{CA} \\ &= (10 + 0 + W_{CA}) J\end{aligned}$$

Given: $\Delta Q = 5J$

From first law of thermodynamics

$$\begin{aligned}5 &= 10 + 0 + W_{CA} \\ \Rightarrow W_{CA} &= -5J\end{aligned}$$

Properties of Material 1) Torsional Torque per unit twist

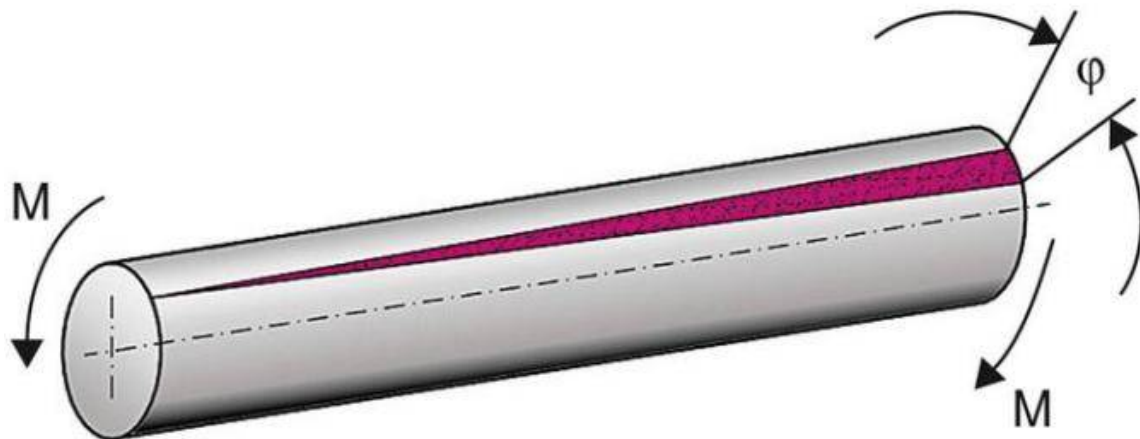

The torque T can be equated to the sum of the moments of the tangential stresses on the element $2\pi r \delta r$.

$$\therefore T = \int s (2\pi r dr) r$$

$$T = \int \frac{C\theta}{l} (2\pi r^3) dr$$

$$= \frac{C\theta}{l} \pi \frac{r^4}{2}$$

Properties of Material 2) Torsion of a cylinder

TORSION OF A CYLINDER/TWISTING WIRE

Let, l = length of cylinder

r = radius of cylinder

ϕ = angle of twist

θ = angle of shear

η = modulus of rigidity

τ = restoring torque developed in the cylinder twisting

c = restoring couple per unit twist

F = tangential force applied at the free end.

(i) Relation between angles of shear and twist

$$BB' = l\theta = r\phi \quad \text{or}$$

$$\theta = \frac{r}{l} \phi$$

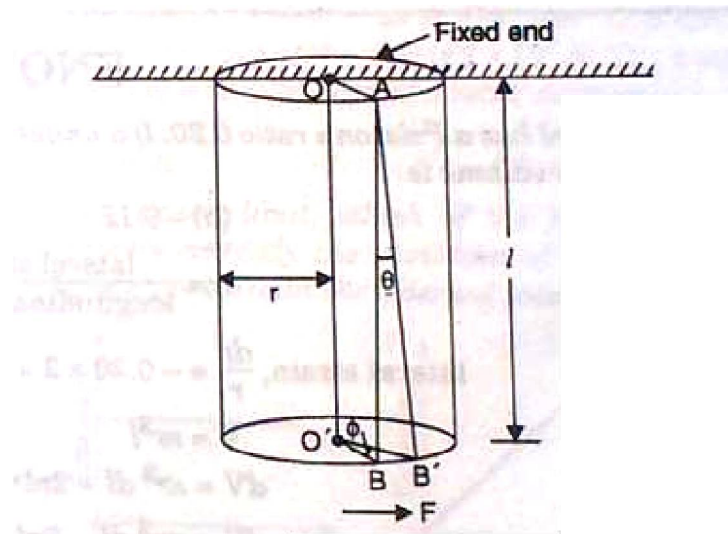

$$(ii) \tau = \frac{\pi \eta r^4}{2l} \phi$$

$$\tau = c\phi$$

(iii) Work done in twisting through angle ϕ is

$$\frac{1}{2} c\phi^2, \text{ i.e., } \frac{\pi \eta r^4}{4l} \phi^2$$

Properties of Material 3) Coefficient of Resilience

3 kinds of Coefficient of Resilience

The amount of energy absorbed per unit volume of the body. This is affected by the class of deformation whether axial, bending, or torsional; hence there are three kinds of coefficients of resilience.

Some Authors refer Coefficient of Restitution as Coefficient of resilience.

If a ball falls from a height falling vertically, and just before hitting the ground, it has a speed of v_1 . Then after hitting the ground it jumps upward with a vertical upward speed of v_2 .

Then the coefficient of restitution $e = \text{mod of } (v_2 / v_1)$

If a ball is moving at u_1 and another is moving at u_2 , they collide. After collision if these move at v_1 and v_2 then $e = \text{mod of } (v_2 - v_1) / (u_2 - u_1)$

Newton 's Law of Cooling by Prof. Subhashish Chattopadhyay SKMClasses Bangalore Useful for IIT-JEE, CBSE, I.Sc. PU-II, Boards, CET, CEE, PET, IGCSE IB AP-Physics and other exams

$$e = \frac{\text{Velocity of Separation}}{\text{Velocity of approach}}$$

$$\text{ie. } e = \frac{V_2 - V_1}{U_2 - U_1} \dots(2)$$

Properties of Material 4) Relations between various Elastic constants

RELATIONS CONNECTING THE ELASTIC CONSTANTS

$$1. K = \frac{Y}{3(1 - 2\sigma)} \quad 3. \frac{9}{Y} = \frac{3}{\eta} + \frac{1}{K}$$

$$2. \eta = \frac{Y}{2(1 + \sigma)} \quad 4. \sigma = \frac{3K - 2\eta}{2(3K + \eta)}$$

Write many times to memorize

Relations between Elastic Constants Y, η, K and σ

$$(i) \eta = \frac{Y}{2(1 + \sigma)} \quad (ii) K = \frac{Y}{3(1 - 2\sigma)}$$

$$(iii) \frac{3}{Y} = \frac{1}{3K} + \frac{1}{\eta} \quad (iv) \sigma = \frac{3K - 2\eta}{2\eta + 6K}$$

There is a mistake in the formula below. Y/η should be $2(1 + \sigma)$

$$\text{Note } \beta = \frac{Y}{3(1 - 2\sigma)}, \frac{Y}{\eta} = 2(1 + \sigma), Y = \frac{\sigma\eta\beta}{\eta + 3\beta},$$

$$\text{Torsional rigidity } C = \frac{k\eta r^4}{2l}$$

Torsional couple (Torque) $G = C\theta$. If tangential stress is T then $\frac{T}{r} = \eta$ where ϕ is shear angle. $\phi =$

$$\frac{x\theta}{l} \text{ where } \theta \text{ is angle of twist.}$$

Newton 's Law of Cooling by Prof. Subhashish Chattopadhyay SKMClasses Bangalore Useful for IIT-JEE, CBSE, I.Sc. PU-II, Boards, CET, CEE, PET, IGCSE IB AP-Physics and other exams

Poisson's ratio cannot exceed

- (a) 0.25 (b) 1.0
(c) 0.75 (d) 0.5

(d) $B = \frac{Y}{3(1-2\sigma)}$ if $B = \infty$ $1 - 2\sigma \rightarrow 0$ or
 $\sigma_{\max} = \frac{1}{2}$.

A copper wire of cross-section A is under a tension T . Find the decrease in the cross-section area. Young's modulus is Y and Poisson's ratio is σ .

- (a) $\frac{\sigma T}{2AY}$ (b) $\frac{\sigma T}{AY}$
(c) $\frac{2\sigma T}{AY}$ (d) $\frac{4\sigma T}{AY}$

$$\frac{\Delta r}{r} = \sigma \frac{\Delta l}{l} \text{ and } \frac{\Delta l}{l} = \frac{T}{AY}$$

$$\frac{\Delta A}{A} = \frac{2\Delta r}{r} = \frac{2\sigma T}{AY}$$

Properties of Material 5) Bending of the Beam

Depression of Beam at center

The Depression of a Beam at its Centre

The depression at the centre of a beam is given by

$$= \frac{MgL^3}{4bd^3Y}$$

M = Suspended Mass, L = Length of the beam, b = Bread of the beam,
 Y = Young's modulus and d = Thickness of the beam

***SUPPORTED BEAM, CENTRALLY LOADED.**
[Assumption : Weight of the beam is ineffective.]

(i) If the beam is of circular cross-section, then depression y is given by :

$$y = \frac{WL^3}{12Y\pi r^4}$$

where W is the load suspended at the middle of the beam, L is the length of the beam between two supported points, Y is Young's modulus of elasticity and r is the radius of the circular cross-section of the beam.

(ii) If the beam is of rectangular cross-section of breadth b and depth d , then depression at the middle is given by

$$y = \frac{WL^3}{4Ybd^3}$$

THE CANTILEVER—DEPRESSION OF ITS LOADED END

[Assumption : Weight of cantilever is ineffective]

$$Y = \frac{WL^3}{3YI}$$

For a beam of rectangular cross-section of breadth b and depth d , $I = \frac{bd^3}{12}$

$$\therefore y = \frac{WL^3 \times 12}{3Y \times bd^3} = \frac{4WL^3}{Ybd^3}$$

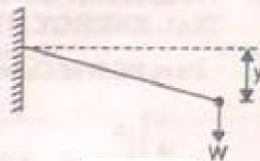

If the cross-section is square in shape, then $b = d$.

$$\therefore I = \frac{b^4}{12}$$

$$\therefore y = \frac{WL^3 \times 12}{3Yb^4} = \frac{4WL^3}{Yb^4}$$

For the beam of circular cross-section of radius r ,

$$I = \frac{\pi r^4}{4}$$

$$\therefore y = \frac{WL^3}{3Y \left[\frac{\pi r^4}{4} \right]} = \frac{4WL^3}{3Y\pi r^4}$$

For the same cross-sectional area and for given load, the ratio of depression for the beam of a square cross-section and circular cross-section is :

- (a) 3 : π
(c) 1 : π

- (b) π : 3
(d) π : 1.

Sol. $y_1 = \frac{4WL^3}{Yb^4}$, $y_2 = \frac{4WL^3}{3Y\pi r^4}$

$$\frac{y_1}{y_2} = \frac{4WL^3}{Yb^4} \times \frac{3Y\pi r^4}{4WL^3} = \frac{3\pi r^4}{b^4} = \frac{3\pi r^4}{(\pi r^2)^2}$$

[$\because b^2 = \pi r^2$]

$$= \frac{3}{\pi}$$

So, (a) is the right choice.

Properties of Material 6) Measurement of Radius of Curvature

To measure the radius of curvature with a spherometer, we use the formula

(a) $R = \frac{h^2}{6} + \frac{l}{2}$

(b) $R = \frac{l^2}{6h} + \frac{h}{2}$

(c) $R = \frac{h^2}{2l} + \frac{l}{h}$

(d) $R = \frac{2l^2}{h} + \frac{6}{l}$

Newton 's Law of Cooling by Prof. Subhashish Chattopadhyay SKMClasses Bangalore Useful for IIT-JEE, CBSE, I.Sc. PU-II, Boards, CET, CEE, PET, IGCSE IB AP-Physics and other exams

A spherometer (Fig. 11) is used to determine the radius of curvature of a spherical surface. The theory of the method is briefly described below :

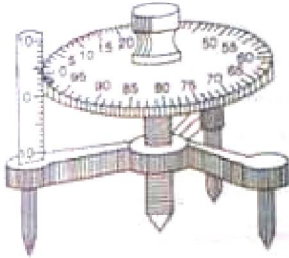

Fig. 11

In the Fig. 12, $r^2 = h(2R - h)$

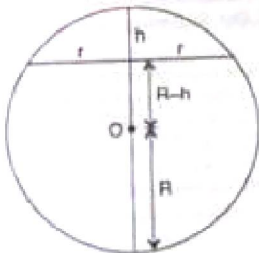

Fig. 12

On simplification,

$$R = \frac{r^2}{2h} + \frac{h}{2}$$

But

$$r = \frac{l}{\sqrt{3}}$$

[Think of an equilateral triangle of side l .]

$$\therefore R = \frac{l^2}{6h} + \frac{h}{2}$$

Newton 's Law of Cooling by Prof. Subhashish Chattopadhyay SKMClasses Bangalore Useful for IIT-JEE, CBSE, I.Sc. PU-II, Boards, CET, CEE, PET, IGCSE IB AP-Physics and other exams

Properties of Material 7) Shear stress

A bar of cross-section A is subjected to equal and opposite tensile forces F at its ends. Consider a plane through the bar making an angle θ with a plane at right angles to the bar. Then shearing stress will be maximum if θ

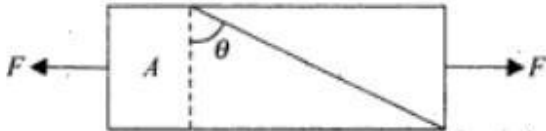

- (a) 0°
- (b) 30°
- (c) 45°
- (d) 60°
- (e) 90°

(c) Shear stress = $\frac{F \sin \theta}{A / \cos \theta} = \frac{F \sin 2\theta}{2A}$

Shear stress will be maximum if $\sin 2\theta = 1$ or $2\theta = 90^\circ$ i.e. $\theta = 45^\circ$.

Properties of Material 8) Thermal stress and force

Thermal Strees

(i) The thermal stress set up in the rod which is not free to expand or contract is given by,

$$\text{Stress in the rod} = \frac{F}{A} = Y \alpha (\theta_2 - \theta_1).$$

Y = Young's modulus, α = Linear coefficient of expansion and $(\theta_2 - \theta_1)$ = Temperature difference.

(ii) Thermal force = $F = YA \alpha (\theta_2 - \theta_1)$

(iii) Two different rods of different materials are joined end to end and the composite rod is fixed between the two supports. The temperature difference is $(\theta_2 - \theta_1)$. Then force is given by

$$F = \frac{L_1 \alpha_1 (\theta_2 - \theta_1) + L_2 \alpha_2 (\theta_2 - \theta_1)}{\frac{L_1}{A_1 Y_1} + \frac{L_2}{A_2 Y_2}}$$

Properties of Material 9) Proof Resilience

Proof resilience is related to

- (a) PE stored in an elastic body.
- (b) stiffness of a beam.
- (c) elastic fatigue.
- (d) elastic relaxation.

Ans : (a)

Properties of Material 10) Elongation in a Pendulum

A sphere of mass M kg is suspended by a metal wire of length L and diameter d . When in equilibrium, there is a gap of Δl between the sphere and the floor. The sphere is gently pushed aside so that it makes an angle θ with the vertical. Find θ_{\max} so that sphere fails to rub the Floor. Young's modulus of the wire is Y .

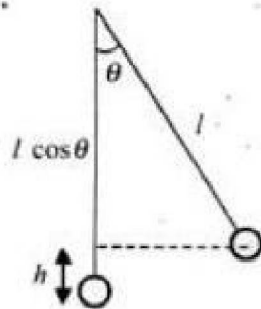

Newton 's Law of Cooling by Prof. Subhashish Chattopadhyay SKMClasses Bangalore Useful for IIT-JEE, CBSE, I.Sc. PU-II, Boards, CET, CEE, PET, IGCSE IB AP-Physics and other exams

$$(a) \sin^{-1} \left(1 - \frac{Y\pi d^2 \Delta l}{8MgL} \right) \quad (b) \tan^{-1} \left(1 - \frac{Y\pi d^2 \Delta l}{8MgL} \right)$$

$$(c) \cos^{-1} \left(1 - \frac{Y\pi d^2 \Delta l}{8MgL} \right) \quad (d) \text{none}$$

Ans : (c) $Y = \frac{Fl}{A\Delta l} = \frac{2Mg(1 - \cos\theta)L}{\pi \frac{d^2}{4} \Delta l}$

or $1 - \cos\theta = \frac{Y\pi d^2 \Delta l}{8Mgl}$ or $\cos\theta = 1 - \frac{Y\pi d^2 \Delta l}{8Mgl}$

$$\frac{mv^2}{2} = mgl(1 - \cos\theta)$$

or $\frac{mv^2}{l} = 2mg(1 - \cos\theta)$

$$\theta = \cos^{-1} \left(1 - \frac{Y\pi d^2 \Delta l}{8MgL} \right)$$

Newton 's Law of Cooling by Prof. Subhashish Chattopadhyay SKMClasses Bangalore Useful for IIT-JEE, CBSE, I.Sc. PU-II, Boards, CET, CEE, PET, IGCSE IB AP-Physics and other exams

Properties of Material 11) Depression at center of rod

A wire of length L is clamped at two ends so that it lies horizontally and without tension. A weight W is suspended from the middle point of the wire. The vertical depression is δ . Young's modulus is Y .

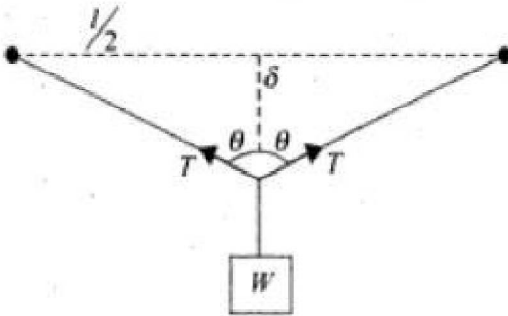

- (a) $\sqrt{\frac{2Tl^2}{4AY} + \frac{T^2l^2}{4A^2Y^2}}$ (b) $\sqrt{\frac{2Tl^2}{4AY} - \frac{T^2l^2}{4A^2Y^2}}$
 (c) $\sqrt{\frac{2Tl^2}{4AY}}$ (d) $\frac{Tl}{2AY}$

(a) $2T \cos \theta = W$

or $T = \frac{W}{2 \cos \theta}$

$$\Delta l = \frac{Tl}{2AY} \quad \delta = \sqrt{\left(\frac{l}{2} + \Delta l\right)^2 - \frac{l^2}{4}}$$

or $\delta = \sqrt{\left(\frac{l}{2} + \frac{Tl}{2AY}\right)^2 - \frac{l^2}{4}} = \sqrt{\frac{2Tl^2}{4AY} + \frac{T^2l^2}{4A^2Y^2}}$

Fluid 1) Bernoulli's Principle and Application

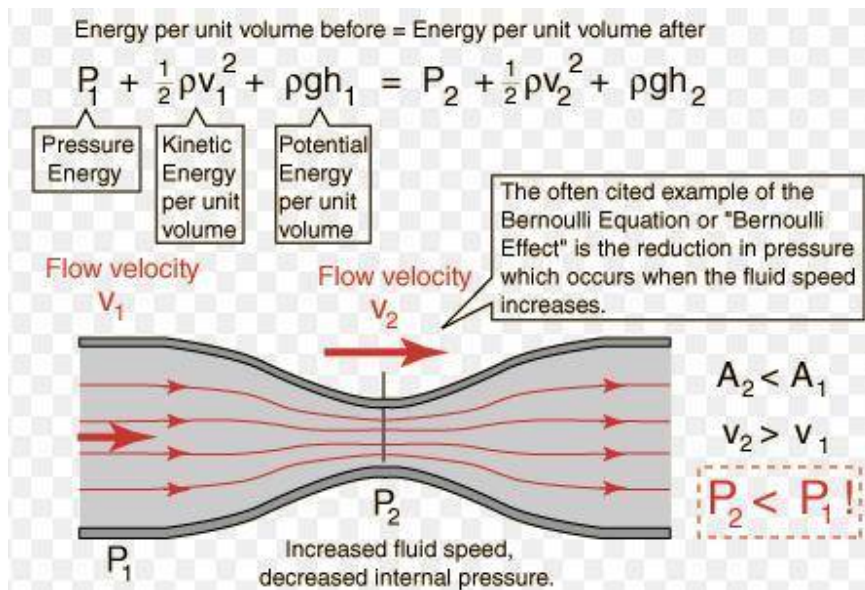

Differential velocity at top and bottom of an aircraft wing, for uplift

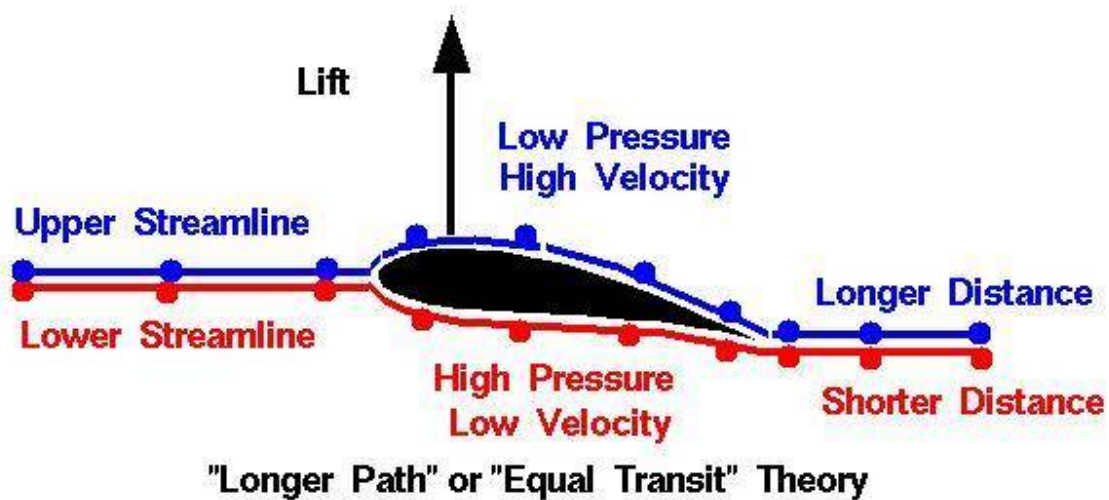

Dynamic lift in aircraft

Aeroplanes get the dynamic lift because of the shape of their wings. The upper surface of the wing is made more curved than the lower surface; air flows with greater speed above the wing; pressure above the wing is less. The wing gets dynamic lift upwards.

$$\text{Dynamic lift} = (P_2 - P_1)A = \frac{1}{2}\rho(v_1^2 - v_2^2)A$$

Where ρ is the density of air, A is the area of the wing, v_1 and v_2 are the speeds of air above and below the wing and P_1 and P_2 are pressures above and below the wing.

Air is streaming past a horizontal air plane wing such that its speed is 90 m s^{-1} at the lower surface and 120 m s^{-1} over the upper surface. If the wing is 10 m long and has an average width of 2 m, the difference of pressure on the two sides and the gross lift on the wing are [Density of air = 1.3 kg m^{-3}]

(a) 5 Pa, 900 N

(b) 95 Pa, 900 N

(c) 4095 Pa, 900 N

(d) 4095 Pa, 81900 N.

Ans :

Pressure Difference = $\Delta P = \frac{1}{2} (\rho) v^2$

$$(d) P_2 - P_1 = \frac{1}{2} \times 1.3 [120^2 - 90^2] = 4095 \text{ Pa}$$

$$\text{Lift} = 4095 \times 2 \times 10 \text{ N} = 81900 \text{ N}$$

A pressure gradient is needed to accelerate the air around the curved upper surface of the wing. Thus the air just above the wing is a zone of low pressure.

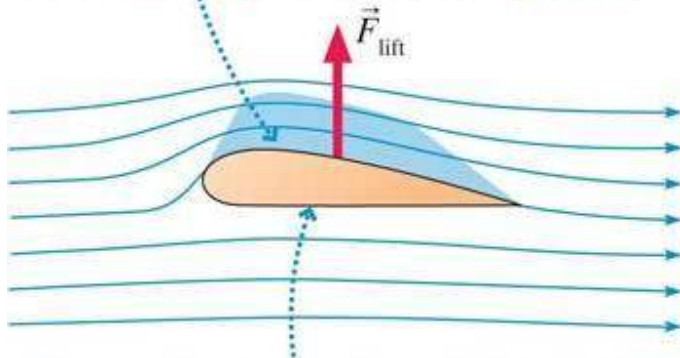

Because the pressure beneath the wing is higher than the pressure above, there's a net upward force on the wing. This is lift.

roof of hut being flown off due to strong wind

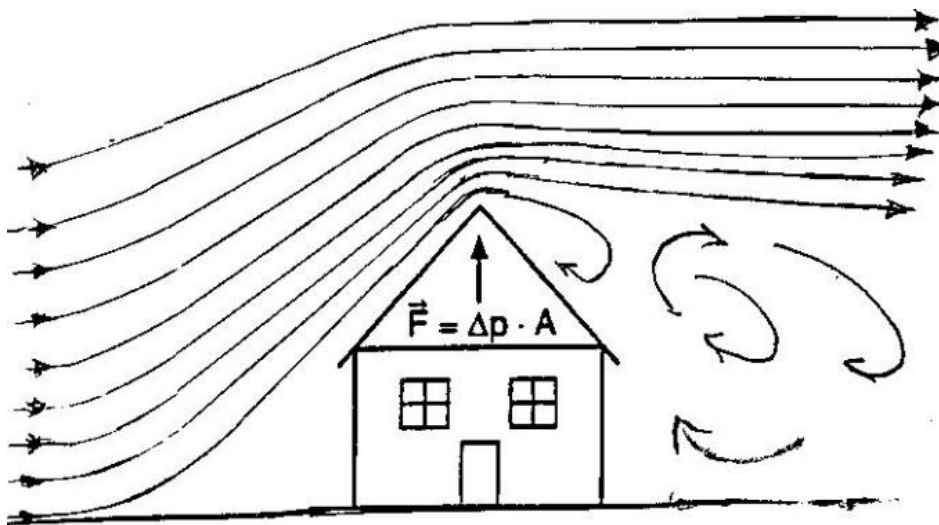

Fluid 2) Magnus Effect Top Spin

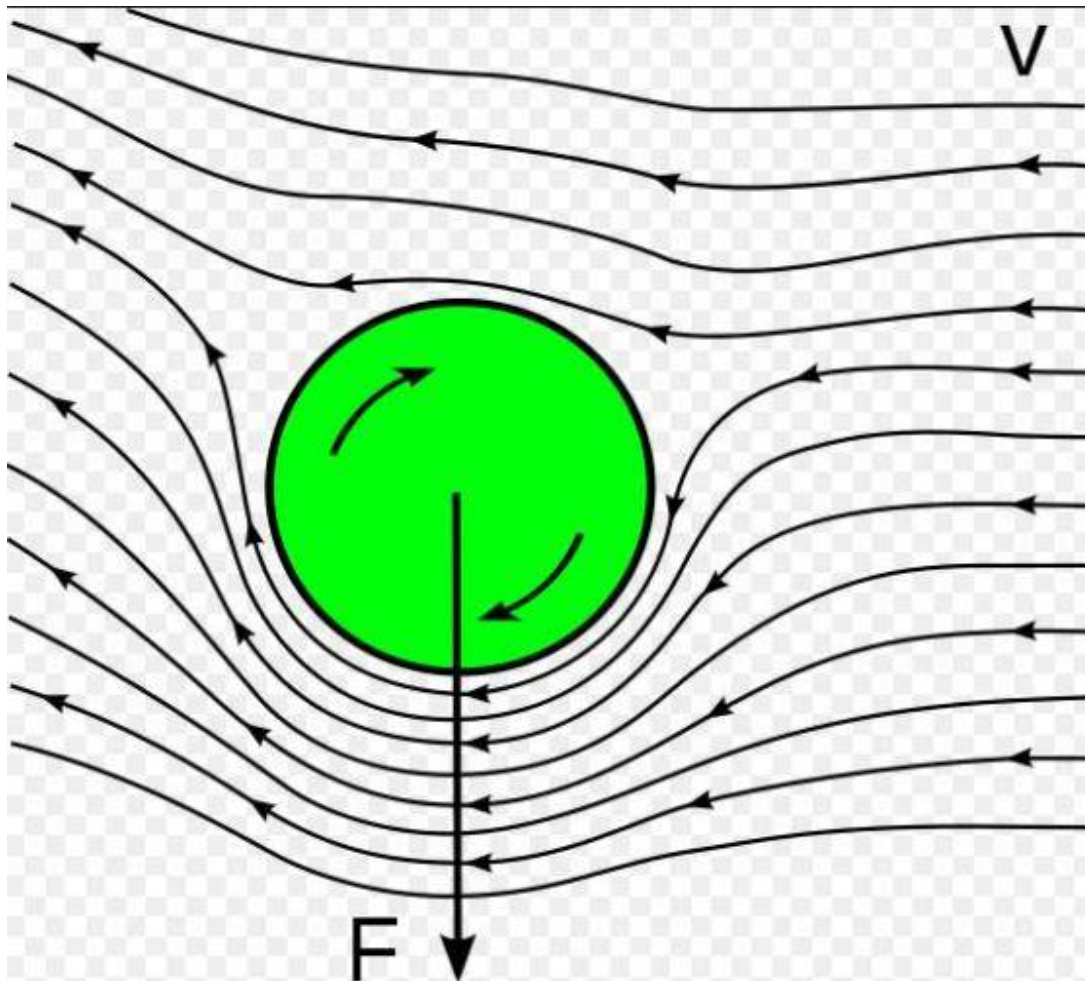

Magnus Effect lift

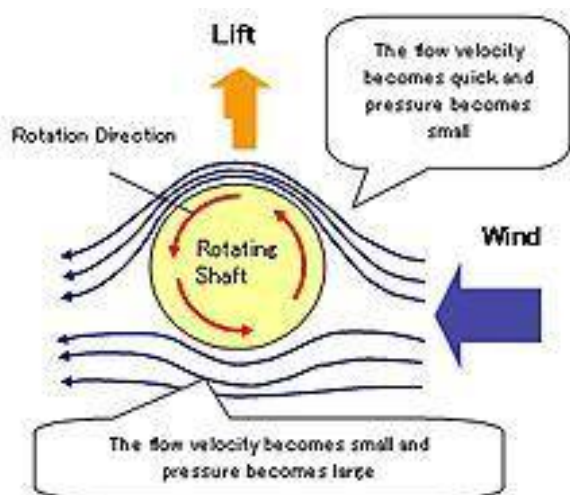

Newton 's Law of Cooling by Prof. Subhashish Chattopadhyay SKMClasses Bangalore Useful for IIT-JEE, CBSE, I.Sc. PU-II, Boards, CET, CEE, PET, IGCSE IB AP-Physics and other exams

Fluid 3) Reynold's Number

$$N_{Re} = \frac{D V C}{\eta}$$

D = inside pipe diameter

V = average velocity

C = density

η = absolute viscosity

Fluid 4) Surface Tension Formula

Work done = energy = Area \times Surface tension

Energy for film = 2(Area \times Surface tension)

Absorbed energy when drop of radius R splits into n identical drops of radius r , is

$$= 4\pi R^2(n^{1/3} - 1)T = 4\pi r^2 n^{2/3} (n^{1/3} - 1)T$$

Excess pressure inside the soap bubble = $\frac{4T}{r}$

Excess pressure inside the liquid drop = $\frac{2T}{r}$

Difference between convex concave side is

$$p = T \left(\frac{1}{r_1} + \frac{1}{r_2} \right)$$

When two drops of radii r_1, r_2 coalesce to form a new drop of radius R under isothermal condition, then $R = \sqrt{r_1^2 + r_2^2}$

When a soap bubble of radius r_1 and another of radius r_2 are brought together the radius of the common interface is $\frac{1}{r} = \frac{1}{r_1} - \frac{1}{r_2}$

Newton 's Law of Cooling by Prof. Subhashish Chattopadhyay SKMClasses Bangalore Useful for IIT-JEE, CBSE, I.Sc. PU-II, Boards, CET, CEE, PET, IGCSE IB AP-Physics and other exams

Fluid 5) Bulk Modulus and Compression of liquid

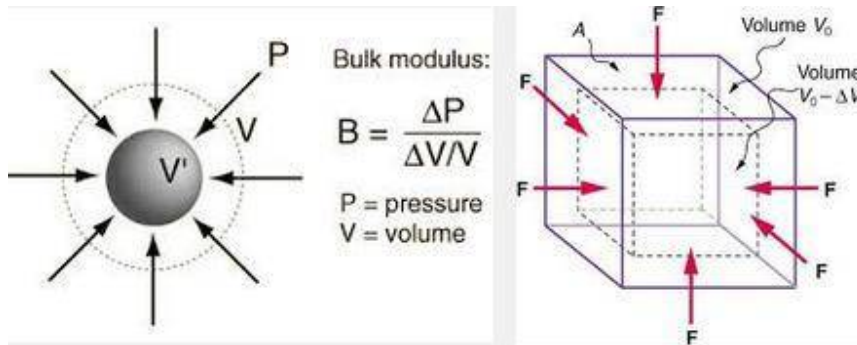

$$\beta = -\frac{\delta V}{V \delta p} = \text{Compressibility}$$

$$-\frac{\delta V}{V} = \frac{\delta p}{K} \quad K = \rho \frac{dp}{d\rho}$$

$$V = \frac{1}{\rho} \quad K = \text{Bulk Modulus}$$

$\rho = \text{Density,}$

$V = \text{Volume, } p = \text{Pressure,}$

Find the density of water 2 km deep in a sea. Bulk modulus = 2×10^9 Pa.

- (a) 10^3 kgm^{-3} (b) 1010 kgm^{-3}
 (c) 1100 kgm^{-3} (d) 1040 kgm^{-3}

$$(b) \frac{\Delta V}{V} = \frac{P}{B} = \frac{2 \times 10^3 \times 10^3 \times 10}{2 \times 10^9} = .01$$

$$\frac{\Delta V}{V} = \frac{\Delta \delta}{\delta} \text{ or } \Delta \delta = 10 \text{ kg/m}^3.$$

density of water = 1010 kg m^{-3}

The average depth of Indian Ocean is about 3000 m. Bulk modulus of water is $2.2 \times 10^9 \text{ Nm}^{-2}$, $g = 10 \text{ ms}^{-2}$, then fractional compression $\left(\frac{\Delta V}{V}\right)$ of water at the bottom of the Indian Ocean is

- (a) 1.36% (b) 20.6% (c) 13.9% (d) 0.52%

Interpret (a) The pressure exerted by a 3000 m column of water on the bottom layer

$$p = h\rho g = 3000 \times 1000 \times 10 \\ = 3 \times 10^7 \text{ kg m}^{-1} \text{ s}^{-2} = 3 \times 10^7 \text{ Nm}^{-2}$$

Fractional compression $\left(\frac{\Delta V}{V}\right)$

$$= \frac{\text{Stress}}{B} = \frac{(3 \times 10^7 \text{ Nm}^{-2})}{(2.2 \times 10^9)} = 1.36 \times 10^{-2}$$

$$\frac{\Delta V}{V} = 1.36\%$$

Find the volume density of elastic energy of fresh water at a depth of 1000 m

- (a) 2.5 kJm^{-3} (b) 25 kJm^{-3}
 (c) 0.25 kJm^{-3} (d) none

$$(b) \frac{dW}{V} = \frac{1}{2} P \frac{\Delta V}{V} = \frac{1}{2} P \left(\frac{P}{B}\right) \\ = \frac{(\rho gh)^2}{2 \times 2 \times 10^9} = \frac{(10^3 \times 10 \times 10^3)^2}{2 \times 2 \times 10^9} = 2.5 \times 10^4 \text{ J/m}^3.$$

A diver at a depth of 45 m exhales a bubble of air that is 1.0 cm in radius. Assuming ideal gas behaviour, what will be the radius of this bubble as it breaks the surface of water?

Plan Inside water $P_{\text{Total}} = \text{atmospheric pressure} + \rho gh$

Using $P_1V_1 = P_2V_2$, V_2 at the surface of water is calculated (V_2 is the volume of bubble at the surface), thus, r can be calculated.

Solution Atmospheric pressure = 1 atm.

Pressure due to depth of 45 m = ρgh

where ρ = density of water = $1 \text{ g cm}^{-3} = 1000 \text{ kg m}^{-3}$,
 $g = 9.81 \text{ m s}^{-2}$, $h = 45 \text{ m}$

$$\rho gh = 1000 \times 9.81 \times 45 \text{ N m}^{-2}$$

$$= \frac{1000 \times 9.81 \times 45}{101325} \text{ atm} = 4.36 \text{ atm}$$

$$(\because 1 \text{ atm} = 1.01325 \times 10^5 \text{ N m}^{-2})$$

$$\therefore P_1 = \text{atmospheric pressure} + \rho gh = 1 + 4.36 = 5.36 \text{ atm}$$

$$P_2 = 1 \text{ atm}$$

$$V_1 = \frac{4}{3} \pi r^3 = \frac{4}{3} \times \pi \times (1)^3 \text{ cm}^3$$

$$V_2 = \frac{4}{3} \pi r^3 = \text{volume of bubble at } P_2 \text{ (at the surface)}$$

using

$$P_1V_1 = P_2V_2$$

$$V_2 = \frac{P_1V_1}{P_2}$$

$$\frac{4}{3} \pi r^3 = \frac{5.36 \times \frac{4}{3} \pi (1)^3}{1}$$

$$r^3 = 5.36 \text{ cm}^3$$

$$r = 1.75 \text{ cm}$$

Fluid 6) Time taken for water to go from h_1 to h_2

A cylindrical vessel of area of cross-section A has a hole of area of cross-section ' a ' in its bottom. Time taken for the water level to decrease from h_1 to h_2 as water flows out from the hole is

$$t = \frac{A}{a} \sqrt{\frac{2}{g}} (\sqrt{h_1} - \sqrt{h_2})$$

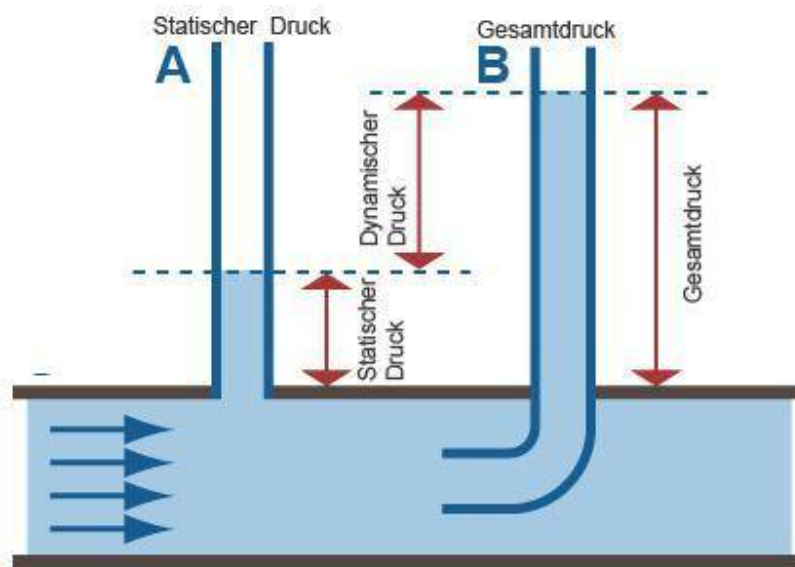
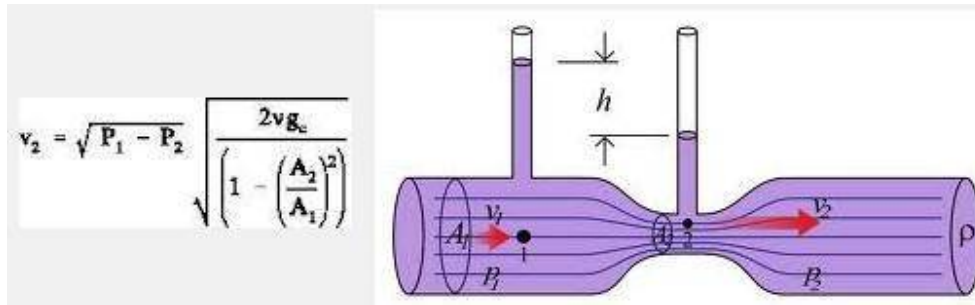

Application of Bernoulli's Equation in Siphon

Application of Bernoulli's Equation

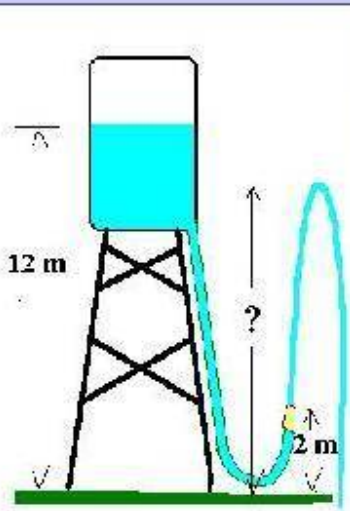

Water level is 12 m above ground. Hose nozzle is 2.0 m above ground.

- 1 What is (gauge) pressure in hose at nozzle?
- 2 What is water speed at nozzle?
- 3 How high does water squirt?

Magnetic Properties of Materials 1) Diamagnetic, Paramagnetic, Ferrimagnetic, Antiferromagnetic

Magnetic Properties : Solids can be classified into different types depending upon their behaviour towards applied magnetic field.

a. Diamagnetic Substances : Which are weakly repelled by magnetic field. They have paired electrons. NaCl, V_2O_5 , TiO_2 .

b. Paramagnetic Substances : Which are weakly attracted by magnetic field. They have permanent dipoles due to presence of unpaired electrons. They lose their magnetism on removal of magnetic field. TiO , Ti_2O_3 , VO, VO_2 , CuO.

c. Ferromagnetic Substances : Spontaneous alignment of magnetic dipoles of ions or atoms in same direction. It changes into paramagnetic substances at higher temperature. Fe, Co, Ni, CrO_2 .

d. Ferrimagnetic Substances : Alignment of magnetic dipoles of ions or atoms in such a way so that there is some net magnetic moment due to unequal number of parallel and anti-parallel magnetic dipoles. It also changes into paramagnetic substances at higher temperature. Fe_3O_4 .

e. Anti Ferromagnetic Substances : Alignment of magnetic dipoles of ions or atoms in such a way so that there is no net magnetic moment (i.e. zero magnetic moment) due to equal number of parallel and anti-parallel magnetic dipoles. V_2O_3 , Cr_2O_3 , MnO, Mn_2O_3 , MnO_2 , FeO, Fe_2O_3 , CoO, NiO.

Projectile Problems

In Professor H C Verma's book there are less than 10 Projectile problems. This is insufficient.

Range and time of flight along an inclined plane

Consider an inclined plane of inclination α . Let a projectile be fixed at an angle θ with the horizontal or at an angle $(\theta - \alpha)$ with respect to incline plane as shown in Fig.

$$\text{The time of flight } T = \frac{2u \sin(\theta - \alpha)}{g \cos \alpha}$$

$$\text{Range } R = \frac{2u^2 \sin(\theta - \alpha) \cos \theta}{g \cos^2 \alpha}$$

$$R = \frac{u^2}{g \cos^2 \alpha} [\sin(2\theta - \alpha) - \sin \alpha]$$

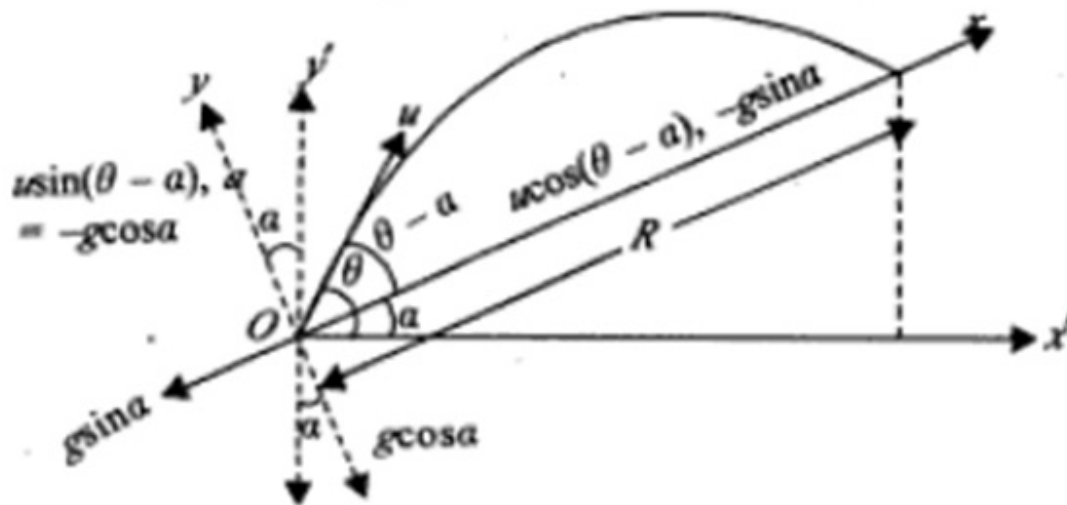

Projectile motion along an incline

Range R along the inclined is maximum if $2\theta - \alpha = \frac{\pi}{2}$

or $\theta - \alpha = \frac{\pi}{2} - \theta$. That is, R is maximum when the direction of projection bisects the angle that the inclined plane makes

with Oy' and $R_{\max} = \frac{u^2}{g \cos^2 \alpha} \cdot [1 - \sin \alpha]$

Note: In projectile motion along the plane acceleration acts along x and y axis both.

Question

A ball is thrown up with a certain velocity so that it reaches a height h . Find the ratio of the times in which it is at $\frac{h}{3}$.

(a) $\frac{\sqrt{2}-1}{\sqrt{2}+1}$

(b) $\frac{\sqrt{3}-\sqrt{2}}{\sqrt{3}+\sqrt{2}}$

(c) $\frac{\sqrt{3}-1}{\sqrt{3}+1}$

(d) $\frac{1}{3}$

Solution (b) $u^2 = 2gh$; $\frac{h}{3} = \sqrt{2gh} t - \frac{1}{2} g t^2$. or $g t^2 - 2$

$$\sqrt{2gh} t + \frac{2h}{3} = 0.$$

$$t = \frac{2\sqrt{2gh} \pm \sqrt{8gh - (8gh)/3}}{2g}$$

$$\frac{t_1}{t_2} = \frac{2\sqrt{2gh} - 2\sqrt{2gh/3}(\sqrt{3}-1)}{2\sqrt{2gh} + 2\sqrt{2gh/3}(\sqrt{3}-1)}$$

$$= \frac{\sqrt{3} - (\sqrt{3}-1)}{\sqrt{3} + \sqrt{3}-1}$$

$$= \frac{\sqrt{3} - \sqrt{2}}{\sqrt{3} + \sqrt{2}}$$

Question

The displacement of a particle varies with time as $x = a e^{-at} + b e^{\beta t}$ where a, a, b, β are positive constants. The velocity of the particle

- (a) will be independent of a and β
- (b) drop to zero when $a = \beta$
- (c) go on decreasing with time
- (d) go on increasing with time.

Solution (d) $\frac{dx}{dt} = -aa e^{-at} + b\beta e^{\beta t}$ as t increases $\frac{-aa}{e^{at}}$ decreases and $b\beta e^{\beta t}$ increases.

Question

Convert given $v - x$ shown in Fig to $a - x$ graph.

(IIT Screening 2005)

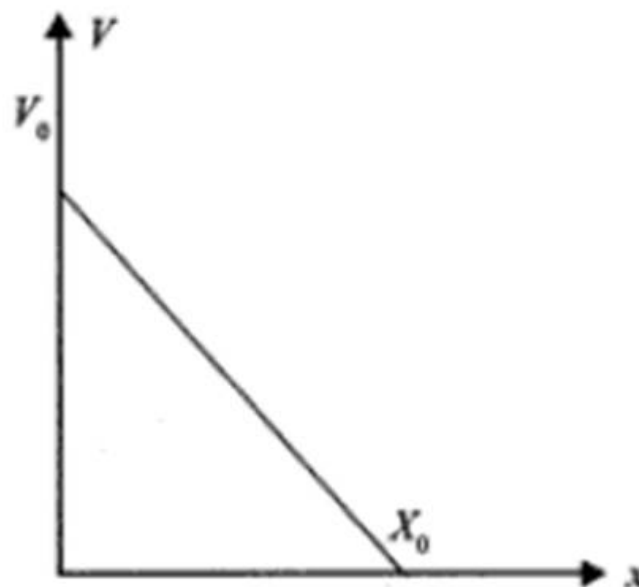

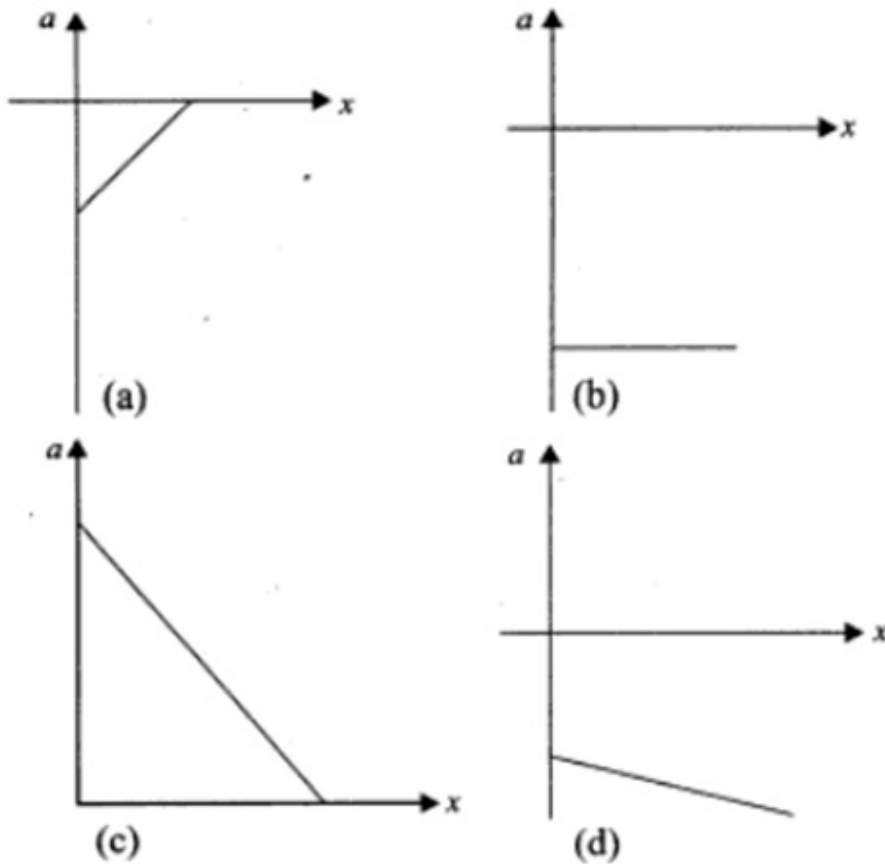

Solution (a) equation of given curve is $v = \left(1 - \frac{x}{x_0}\right) v_0$

$$a = \frac{dv}{dt} = -\frac{v_0}{x_0} \frac{dx}{dt} = \frac{-v_0^2}{x_0} \left(1 - \frac{x}{x_0}\right)$$

Question

The relation between time t and distance x is $t = ax^2 + bx$

where a and b are constant. The acceleration is

- (a) $-2a bv^2$ (b) $2 bv^3$
 (c) $-2 av^3$ (d) $2 av^2$

Solution (c) $t = ax^2 + bx$ or $\frac{dt}{dx} = 2ax + b$

or $v = \frac{dx}{dt} = \frac{1}{2ax + b}$.

$$\frac{dv}{dt} = \frac{-2a}{(2ax + b)^2} \frac{dx}{dt} = \frac{-2a}{(2ax + b)^3} = -2a v^3.$$

Question

A car starting from rest accelerates at the rate f through a distance s , then continues at constant speed for time

t and then decelerates at rate $\frac{f}{2}$ to come to rest. If the

total distance covered is $15s$, then

(a) $s = \frac{ft^2}{72}$

(b) $s = \frac{ft^2}{4}$

(c) $s = \frac{ft^2}{6}$

(d) $s = \frac{ft^2}{2}$

Solution (a) $s = v_0 t_1$ and $v_0 2t_1 = 2s$

Distance moved with uniform speed $(15 - 3) s = 12 s$

$$v_0 = \sqrt{2sf} ; 12s = v_0 t$$

$$12s = t \sqrt{2sf} \quad \text{or} \quad s = \frac{ft^2}{72}$$

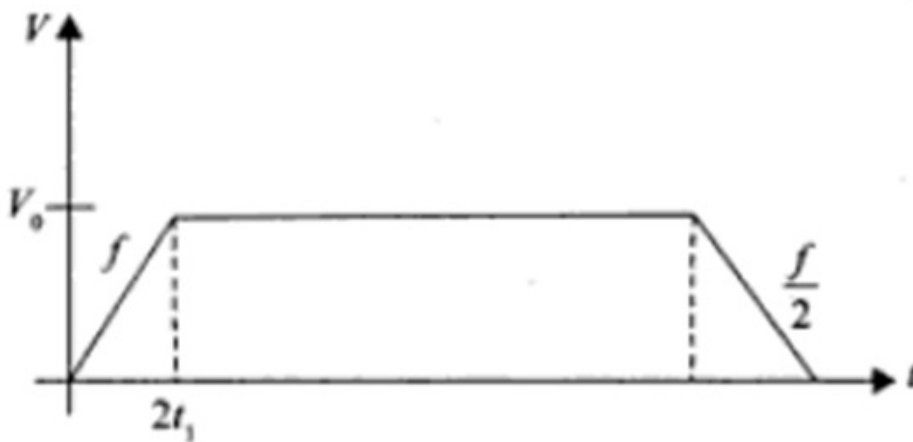

Question

A projectile is any body that is given an initial velocity and then follows a path determined entirely by the effects of gravitational acceleration and air resistance. A batted baseball, a thrown football, a package dropped from an airplane, and a bullet shot from a rifle are all projectiles. The path followed by a projectile is called its trajectory.

Represent the projectile as a single particle with an acceleration (due to gravity) that is constant in both magnitude and direction. Neglect the effects of air resistance and the curvature of the Earth and its rotation. Like all models, this one has limitations. Curvature of the earth has to be considered in the flight of long range missiles and air resistance is of crucial importance to a sky diver.

1. If air resistance is considered, then the maximum height achieved by the projectile
 - (a) decreases
 - (b) increases
 - (c) remains unchanged
 - (d) very difficult to answer as no data provided

Solution (a)

2. Air resistance is proportional to

(a) v

(b) v^2

(c) v^{-2}

(d) v^3

Solution (b) To a good approximation air resistance $\propto v^2$.

3. Comparing with no air-resistance curve, for the motion of a baseball with effect of air resistance, the correct curve will be

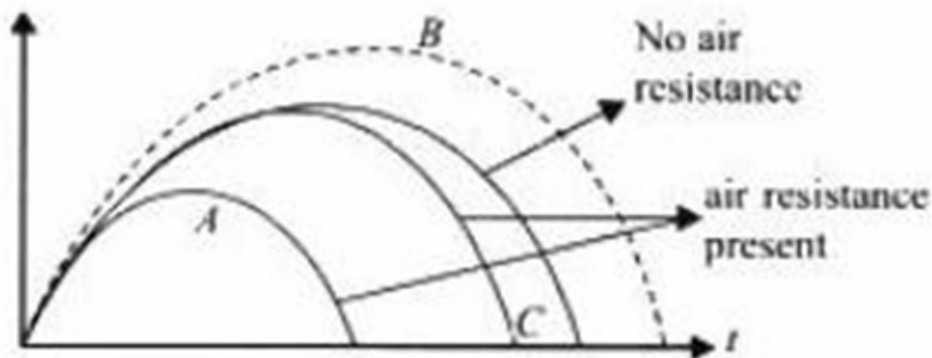

(a) A

(b) B

(c) C

(d) none

Solution (a)

4. A gun is fired horizontally on the bull's eye at a height h
- (a) The bullet hits the bull's eye
 - (b) The bullet moves left or right of the Bull's eye due to jerk experienced on firing
 - (c) The bullet misses the bull's eye and hits upward
 - (d) The bullet misses the target and hits downwards

Solution (d) due to gravity it follows projectile path (parabolic) and moves downward.

Question

Journey in a train is adventurous particularly when you have a seat. The girl sitting near the window ate a banana and dropped the peel from the window. Her copassenger looking through the window found that it dropped vertically down and touched the ground in 0.2 s. After some time she requested her sister sitting on the upper berth to drop a chocklate bar. The sister dropped the bar, but it fell in front of the girl instead of reaching her hand. She was angry but the co-passenger calmed her by saying that she dropped exactly in line of your hand but as the train is accelerating it did not reach you and fell in front of you.

1. Is the co-passenger's explanation to the girl correct?

Solution No, the train is actually retarding. When the girl on the upper berth released the chocolate train was faster and the chocolate acquired the same horizontal velocity but the train retarded and became slow. Therefore, the girl sitting on the lower berth (due to motion of train) covered lesser distance and the chocolate covered longer distance and fell in front of her hands.

2. An observer standing outside the train finds the banana peel moving

- (a) vertically down (b) in parabolic path
(c) horizontally (d) cycloid

Solution (b)

3. If the train would have moved with uniform velocity the chocolate will fall

- (a) behind her hands (b) towards left
(c) towards right (d) in her hands

Solution (d)

4. If a projectile has velocity $>$ escape velocity which trajectory it will follow

- (a) elliptic (b) hyperbolic
(c) vertical straight (d) parabolic

Solution (b)

5. Two particles are thrown with 8 ms^{-1} as shown in Fig. 3.42 one horizontally from a height of 40 m and the other from a height of 50 in making an angle 60° with the vertical. They strike in mid air. Find the coordinates of strike point and distance between the buildings.

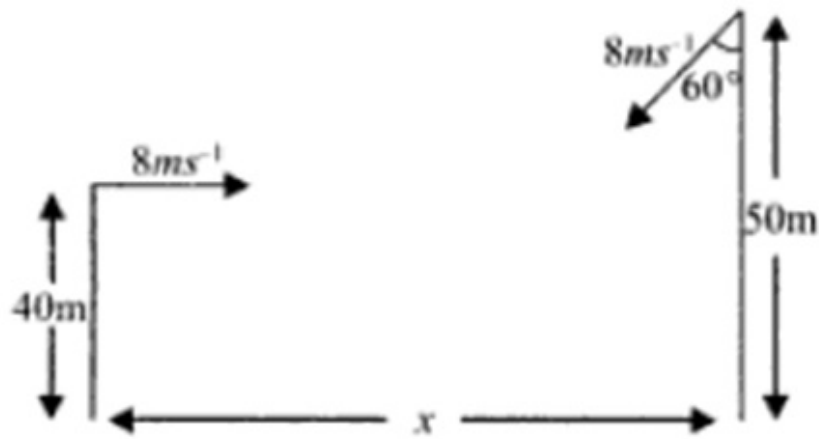

Solution $\frac{1}{2} gt^2 = y ; y + 10 = 8 \cos 60t + \frac{1}{2} gt^2$

$$y_1 = \frac{10}{2} \times (2.5)^2 = 31.25 \text{ m ;}$$

$$y_2 = y_1 + 10 = 41.25 \text{ m}$$

$$x_1 = 8 (2.5) = 20 \text{ m ;}$$

$$x_2 = 8 \sin 60 \times 2.5 = 17.32 \text{ m}$$

$$x = 20 + 17.32 = 37.32 \text{ m}$$

Question

Electrons, nuclei, atoms and molecules like all forms of matter, will fall under the influence of gravity. Consider separately the beam of electrons, of nuclei, of atoms and of molecules travelling a horizontal distance of 1 m. Let the average speed of electrons be $3 \times 10^7 \text{ ms}^{-1}$, for a thermal neutron $2.2 \times 10^5 \text{ ms}^{-1}$, for a neon atom $5.8 \times 10^2 \text{ ms}^{-1}$ and for an oxygen molecule $4.6 \times 10^2 \text{ ms}^{-1}$. The beams move through vacuum horizontally with initial velocities mentioned above. A golf ball is also projected horizontally with 20 ms^{-1} in vacuum.

1. Out of the given beams which deviates maximum in travelling 2 m?
(a) electron beam (b) neutron beam
(c) neon atom (d) oxygen atom
2. Find the deviation of golf ball in travelling through 2 m.
(a) 2 cm (b) 5 cm
(c) 8 cm (d) 3.6 cm
3. Is there any effect of electron-electron repulsion?
(a) Yes (b) No
(c) insufficient data to reply (d) none

Solution

1. (d) Deviation $y = \frac{1}{2} g t^2$ and $t = \frac{x}{v}$ or $y = \frac{1}{2} g \left(\frac{x}{v} \right)^2$.

2. (b) $y = \frac{1}{2} g \left(\frac{2}{20} \right)^2 = 5 \text{ cm}$

3. (b) Since the net velocity has already taken into account the repulsion, no effect of repulsion is to further added.

Question

Radar is used for ranging of the projectiles. A radar observer on the ground is watching an approaching projectile. At a certain instant, he gathers the following information. The projectile has reached maximum altitude and is moving

horizontally with a speed v , the straight line distance of the projectile is l . The line of sight to the projectile is an angle θ above the horizontal. D is the distance between the observer and the point of impact of the projectile. Assume observer lies in the plane of the trajectory and the Earth is flat in that part.

1. Find D in terms of l , v and θ .

(a) $\frac{gl^2}{v^2} \cot \theta$

(b) $\frac{gl^2}{v^2} \tan \theta$

(c) $\frac{gl^2}{2v^2} \tan \theta$

(d) $\frac{gl^2}{2v^2} \cot \theta$

2. Does the projectile pass over his head before reaching him?

(a) Yes

(b) No

(c) insufficient data to reply

Solution 1. (d) $l = \frac{u^2 \sin \alpha \cos \alpha}{g} = \frac{v}{g} v_x$

$$v_x = \frac{gl}{v}$$

$$h = \frac{v_x^2}{2g} = \frac{g^2 l^2}{2v^2 g} = \frac{gl^2}{2v^2}$$

$$\frac{D}{h} = \cot \theta$$

or $D = h \cot \theta = \frac{gl^2}{2v^2} \cot \theta$

2(c) If $\theta < \alpha$, the angle of projection of projectile, then the projectile will fall before reaching him.

Radius of Curvature of a Projectile

Find the radius of curvature of the trajectory of a projectile projected with velocity u at an angle α with the horizontal after t seconds from the instant of projection.

Solution : We have,

$$\vec{r} = u \cos \alpha t \hat{i} + (u \sin \alpha t - \frac{1}{2}gt^2) \hat{j}$$

$$\vec{v} = u \cos \alpha \hat{i} + (u \sin \alpha - gt) \hat{j}$$

Let θ be the angle made by the velocity with the horizontal. Then

$$\tan \theta = \frac{u \sin \alpha - gt}{u \cos \alpha}$$

The component of mg along the normal is $mg \cos \theta$ and that is the centripetal force.

$$\therefore mg \cos \theta = \frac{mv^2}{R_c}, R_c = \text{radius of curvature.}$$

$$\Rightarrow R_c = \frac{v^2}{g \cos \theta} = \frac{u^2 \cos^2 \alpha + (u \sin \alpha - gt)^2}{u \sin \alpha} \\ = \frac{g \sqrt{u^2 \cos^2 \alpha + (u \sin \alpha - gt)^2}}{\{u^2 \cos^2 \alpha + (u \sin \alpha - gt)^2\}^{3/2}} \\ = \frac{gu \sin \alpha}{\{u^2 \cos^2 \alpha + (u \sin \alpha - gt)^2\}^{3/2}}$$

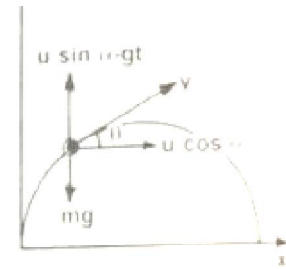

A Special Problem on Average Relative Velocity

A large number of particles are moving each with velocity v having directions of motion randomly distributed. What is the average relative velocity between any two particles averaged over all the pairs?

- (a) v (b) $\frac{\pi}{4} v$ (c) $\frac{4}{\pi} v$ (d) $4\pi v$

Relative velocity: $v_r = |\vec{v}_1 - \vec{v}_2|$

where $v_1 = v_2 = v$

If angle between them be θ , then

$$\begin{aligned} v_r &= \sqrt{v^2 + v^2 - 2v^2 \cos \theta} \\ &= \sqrt{2v^2(1 - \cos \theta)} = 2v \sin (\theta/2) \end{aligned}$$

Hence, average relative velocity

$$\vec{v}_r = \frac{\int_0^{2\pi} 2v \sin \frac{\theta}{2} d\theta}{\int_0^{2\pi} d\theta} = \frac{4v}{\pi}$$

A modified problem from Irodov regarding "Spring constant" and height of fall

Two discs each having mass m are attached rigidly to ends of a spring. One of the discs rests on a horizontal surface and the other produces a compression x on the spring when it is in equilibrium. How much further must the spring be compressed so that when the force causing the compression is removed the extension of the spring will be able to lift the lower disc off the table?

- (a) x (b) $2x$
(c) $1.5x$ (d) $3x$

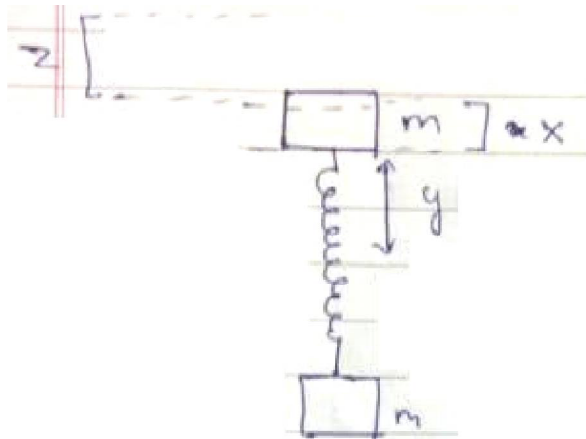

Initially, the spring is compressed by x to balance mg of top block
 $\therefore kx = mg \Rightarrow x = \frac{mg}{k}$

The block should be pushed down by y such that when the spring reaches position z , bottom block should jump up.

$$\therefore kz = Mg \Rightarrow z = \frac{Mg}{k}$$

Using energy conservation,

$$\frac{1}{2} k (x+y)^2 = \frac{1}{2} k z^2 + mg(x+y+z)$$

$$\frac{1}{2} k \left(\frac{mg}{k} + y \right)^2 = \frac{1}{2} k \left(\frac{mg}{k} \right)^2 + mg \left(\frac{2mg}{k} + y \right)$$

$$k \left(\frac{mg}{k} + y \right)^2 = k \left(\frac{mg}{k} \right)^2 + 2mg \left(\frac{2mg}{k} + y \right)$$

$$\Rightarrow k \left(\frac{m^2g^2}{k^2} + \frac{2mgy}{k} + y^2 \right) = k \left(\frac{m^2g^2}{k^2} \right) + \frac{4m^2g^2}{k} + 2mgy$$

$$\Rightarrow \frac{m^2g^2}{k} + 2mgy + y^2 k = \frac{m^2g^2}{k} + \frac{4m^2g^2}{k} + 2mgy$$

$$\Rightarrow y^2 = \frac{4m^2g^2}{k^2} \Rightarrow y^2 = 4a^2$$

$$\Rightarrow \boxed{y = 2a}$$

So, if the block is pushed down by distance $2a$ more, when released, the system will jump up

Melde's Experiment

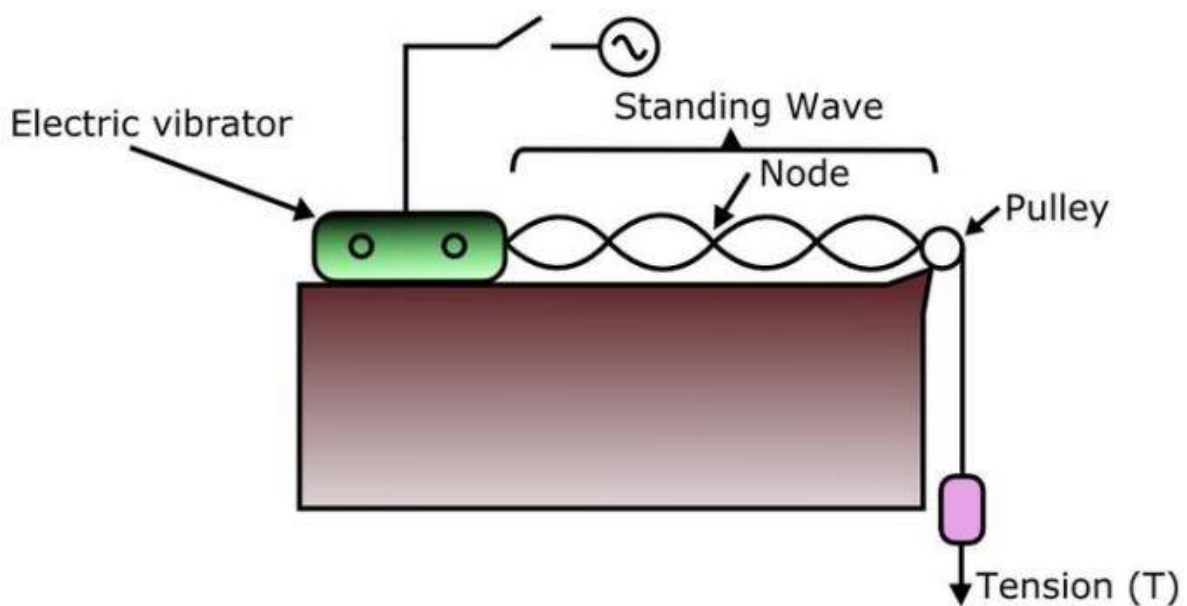

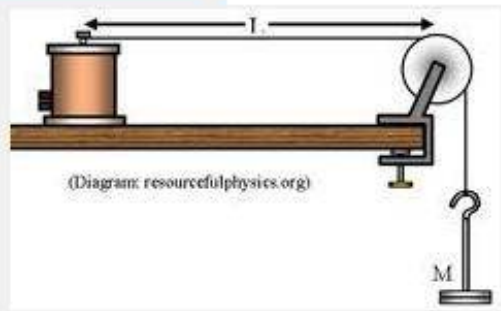
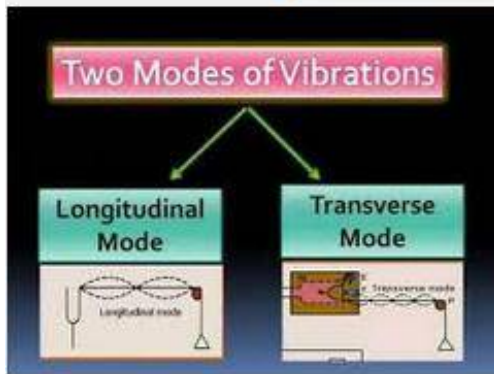
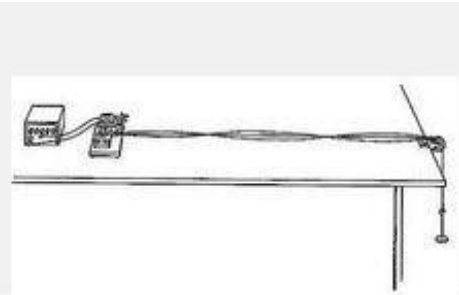
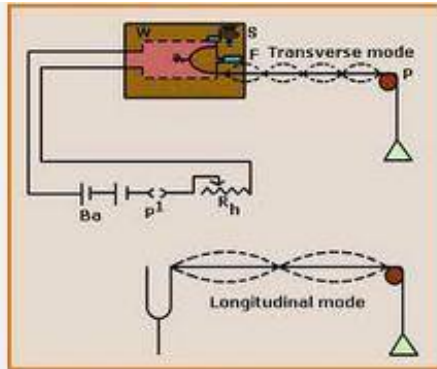

$$f = \frac{n}{2L} \sqrt{\frac{T}{m}}$$

A plane wave $\zeta = A \cos(\omega t - kx)$ propagates in the reference frame S . Find the equation of this wave in a reference frame S' moving in the +ve direction of x -axis with a constant velocity V relative to S .

$$x = x' + Vt \quad \therefore \frac{dx}{dt} = \frac{dx'}{dt} + V$$

$$\therefore \xi' = A \cos \{ \omega t - k(x' + Vt) \} = A \cos \{ (\omega - kV)t - kx' \}$$

$$\text{or} \quad \xi' = A \cos \left\{ \omega t \left(1 - \frac{kV}{\omega} \right) - kx' \right\}.$$

Let $D = \dots$
 But $\frac{k}{\omega} = v$, velocity of wave.

$$\therefore \xi' = A \cos \left[\omega \left(1 - \frac{V}{v} \right) t - kx' \right].$$

Which of the following represents (a) a progressive wave and (b) a stationary wave?

(a) $y = 2 \cos 5x \sin 9t$, (b) $y = 2 \sqrt{x - vt}$,

(c) $y = 3 \sin (5x - 0.5t) + 4 \cos (5x - 0.5t)$

(d) $y = \cos x \sin t + \cos 2x \cdot \sin 2t$. If progressive, find its velocity.

(a) Stationary wave; (b) unacceptable for wave.

(c) Put $3 = A \cos \phi$, $4 = A \sin \phi$.

Then $y = A \cos \phi \sin (5x - 0.5t) + A \sin \phi \cos (5x - 0.5t)$

$y = A \sin (5x - 0.5t + \phi)$.

This fits the equation of progressive wave in the standard form:

$$y = A \sin \left(\frac{2\pi}{\lambda} x - \omega t + \phi \right).$$

\therefore Here $\frac{2\pi}{\lambda} = 5$ and $0.5 = \omega$

$\therefore v = n\lambda \frac{0.5}{2\pi} \times \frac{2\pi}{5} = 0.1 \text{ m/s.}$

(d) Superposition of two stationary waves.

A wave problem with interpretation of equation

The shape of a wave is represented by $y = \frac{1}{1+x^2}$ at $t = 0$ and $y = \frac{1}{1+(x-1)^2}$ at $t = 2s$. Assume that the shape of the wave remains unaltered as it advances in the medium. Find the velocity of the wave and represent the wave graphically.

[IIT 1990]

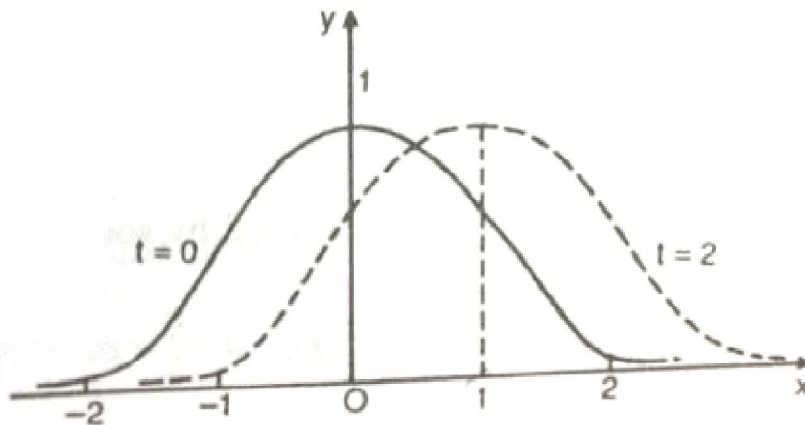

Obviously the wave advances by 1 m in 2 s.

$$\therefore V = \frac{1}{2} = 0.5 \text{ m/s.}$$

The following equations represent transverse waves: $z_1 = A \cos(kx - \omega t)$, $z_2 = A \cos(kx + \omega t)$, $z_3 = A \cos(ky - \omega t)$. Identify the combination (s) of the waves which will produce (i) standing waves (s), (ii) a wave travelling in the direction making an angle of 45° with the positive x and positive y -axes. In each case find the positions at which the resultant intensity is always zero. [IIT 1987]

The first and the second equations represent waves travelling in opposite directions along x -axis. Hence they combine to form stationary waves.

$$z = z_1 + z_2 = A \cos (kx - \omega t) + A \cos (kx + \omega t).$$

This is equation of stationary waves. The intensity is zero when $\cos kx = 0$

or $kx = (2S + 1) \frac{\pi}{2}$ where $S =$ any integer including zero

or $x = \frac{(2S + 1)\pi}{2k}$.

The resultant of 1 and 3 is given by

$$\begin{aligned} z &= z_1 + z_3 = A \cos (kx - \omega t) + A \cos (ky - \omega t) \\ &= 2A \cos \left[\frac{1}{2}k(x + y) - \omega t \right] \cos \frac{1}{2}k(x - y) \end{aligned}$$

or
$$z = 2A \cos \frac{1}{2} k(x - y) \cos \left(\frac{1}{2} k(x + y) - \omega t \right). \quad \dots (i)$$

The most general equation of a wave is

$$z = C \cos (\vec{k} \cdot \vec{r} - \omega t)$$

where C is a constant representing amplitude of the wave, \vec{k} is the wave vector and \vec{r} is the position vector of the point in space through which wave is travelling.

The equation of a wave travelling along 45° with x - and y - axes in the xy plane is given by
$$z = C \cos [k(x + y) - \omega t]. \quad \dots (ii)$$

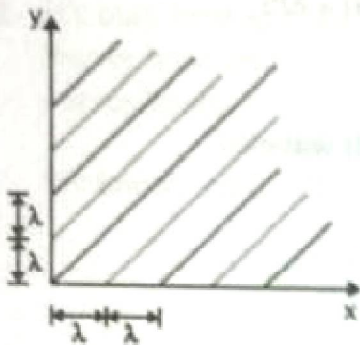

Fig. 1.2

Comparing the two equations we find that (i) represents a travelling wave of wave vector $\frac{k}{2}$ along 45° inclination with x - and y - axes. The amplitude of the wave is proportional to $\cos \frac{1}{2} k(x - y)$.

Hence intensity is zero at positions

$$\frac{1}{2} k(x - y) = \pm (2S + 1) \frac{\pi}{2}$$

or
$$x = y \pm \frac{(2S + 1) \pi}{k}.$$

The particles of the medium at the points on the dotted lines will have no motion and hence intensity will be zero along these lines.

Beats of Beats

Three sound waves of frequencies 320, 344 and 280 are produced simultaneously. Find the number of beats per second, assuming the human ear's resolution is 10 beats per second.

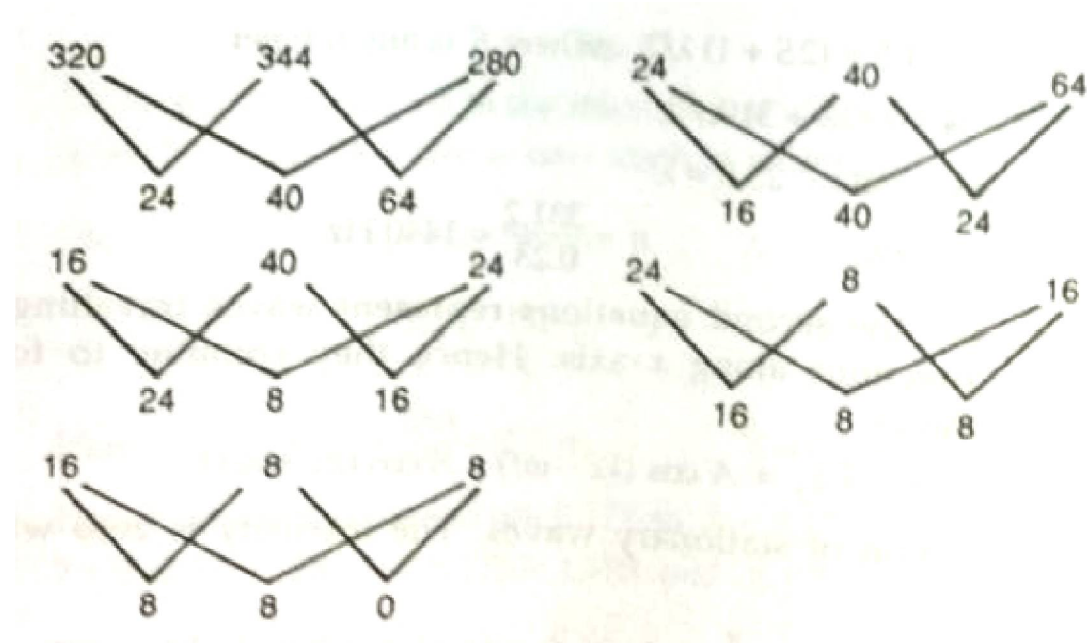

Question

One end of a rope is tied to a peg on the wall. The other free end is held taut by the hand and periodically shaken. A wave travels down the rope sinusoidally with frequency 2.0 Hz and amplitude 7.5 cm. The wave speed is 12.0 m s^{-1} . Find the angular frequency, period, wavelength and wave number of the wave. Write the equation for the displacement as a function of time.

Solution

$$\text{Angular frequency } \omega = 2\pi f = 4\pi \text{ rad s}^{-1} = 12.6 \text{ rad s}^{-1}$$

$$\text{Time period } T = \frac{1}{f} = 0.5 \text{ s}$$

$$\text{wavelength } \lambda = \frac{v}{f} = 12.0 \times 0.5 = 6.0 \text{ m}$$

$$\text{wave number } k = \frac{2\pi}{\lambda} = \frac{2\pi}{6} = 1.05 \text{ rad m}^{-1}$$

$$y = A \sin(kx - \omega t) = (0.075 \text{ m}) \sin[(1.05 \text{ rad m}^{-1}x - (12.6 \text{ rad s}^{-1})t)]$$

Power of a wave (P)

The energy contained in a volume element of the medium in unit time is called the power of the wave. Energy contained in an element of length ' Δx ' and area of cross section ' a ' in a time ' Δt ' will be $E = U a \Delta x$

$$\therefore \text{ Power of the wave } P = \frac{E}{\Delta t} = \frac{ua\Delta x}{\Delta t}$$

$$P = Uav = 2\pi^2 f^2 A^2 \rho av$$

$$(\because \text{ wave velocity, } v = \frac{\Delta x}{\Delta t})$$

Intensity of a wave (I)

Intensity of a wave is defined as the energy transferred in unit time or power transmitted across unit area held perpendicular to the direction of propagation of the wave. SI unit of intensity is $W m^{-2}$.

$$I = \frac{P}{a} = Uv$$
$$= 2\pi^2 f^2 A^2 \rho v. \text{ Therefore,}$$

Intensity of a wave = Energy density of the wave \times speed of the wave

Hence, intensity of a wave is directly proportional to

- (i) the square of its amplitude,**
- (ii) the square of its frequency,**
- (iii) the velocity of propagation and**
- (iv) the density of the medium through which it travels.**

Question

In Concept Strand 7, calculate the intensity of the wave, if the linear density of the rope is $250 g m^{-1}$.

Solution

$$I = \frac{1}{2} \omega^2 A^2 \rho v = \frac{1}{2} (12.6 \text{ rad s}^{-1})^2 (0.075 \text{ m})^2 (0.25 \text{ kg m}^{-1}) (12 \text{ m s}^{-1})$$

$$= 1.34 \text{ W}$$

Question

Two waves traveling in the positive x-direction having same amplitude, same frequency, same speed and phase difference of $\pi/2$ between them superimpose. Find the expression for the resultant wave and sketch the profile of the resultant wave at any instant.

By formula, the amplitude of the resultant wave

$$= \sqrt{A^2 + A^2 + 2A^2 \cos\left(\frac{\pi}{2}\right)} = \sqrt{2}A$$

$$\text{Phase of the resultant wave} = \tan^{-1}\left(\frac{A \sin \frac{\pi}{2}}{A + A \cos \frac{\pi}{2}}\right)$$

$$= \frac{\pi}{4} \text{ radian}$$

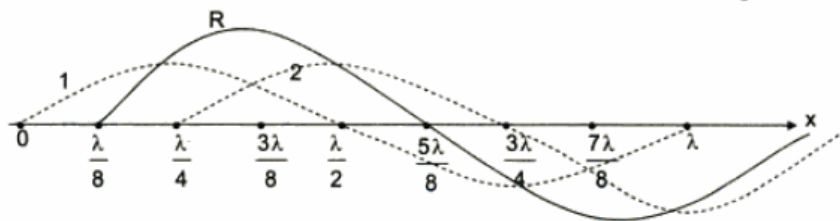

1 and 2 are the component waves and R is the resultant.

We know that the intensity of a wave I is proportional to square of amplitude (A) and square of frequency (f).

i.e., $I \propto A^2 f^2$

or

$$I_{\min} = (\sqrt{I_1} - \sqrt{I_2})^2$$

This is called destructive interference. If $\cos \delta = 0$, then

Hence, for waves of the same frequency, $I \propto A^2$

$$\Rightarrow I = pA^2, I_1 = pA_1^2 \text{ and } I_2 = pA_2^2$$

where p = constant of proportionality $pA^2 = pA_1^2 + pA_2^2 + 2pA_1A_2\cos\delta$ (by multiplying the amplitude of resultant wave with p)

$$\text{i.e., } I = I_1 + I_2 + 2\sqrt{I_1I_2}\cos\delta$$

is the resultant intensity of the superimposed waves.

The term $2\sqrt{I_1I_2}\cos\delta$ in the resultant intensity expression is called the *Interference factor*. The magnitude and sign (positive or negative) of the interference factor depends upon δ (the phase difference with which the waves superimpose at a point in the medium). Maximum intensity (I_{\max}) occurs when $\cos\delta = 1$. Therefore,

$$I_{\max} = I_1 + I_2 + 2\sqrt{I_1I_2}$$

or

$$I_{\max} = \left[\sqrt{I_1} + \sqrt{I_2} \right]^2$$

This is called *constructive interference*

Minimum intensity (I_{\min}) occurs, when $\cos\delta = -1$. Therefore,

$$I_{\min} = I_1 + I_2 - 2\sqrt{I_1I_2}$$

$$I = I_1 + I_2.$$

The phenomenon of interference is based on the law of conservation of energy. There is no loss of energy in interference. Energy which disappears in regions of minimum intensity appears in regions of maximum intensity.

When waves produced by non-coherent sources superimpose, the resultant intensity is the sum of the intensities of the individual waves. i.e., $I = I_1 + I_2$ Interference factor $2\sqrt{I_1I_2}\cos\phi = 0$ for non-coherent waves, because ϕ can have all values and average value of $\cos\phi$ is zero.

Interference phenomenon can occur in transverse waves as well as longitudinal waves. It can also occur in mechanical waves and electromagnetic waves (Example, light). Two separate lamps of same frequency can never produce interference, as they are not coherent sources. Production of light is an atomic phenomenon (microscopic property of matter) and there is no constant phase relationship between the light produced by different sources.

However, two separate sources of sound of same fre-

quency may produce interference phenomenon because propagation of sound through a medium is a bulk property of the medium (macroscopic property of matter) and such sources of sound could be coherent sources.

Question

A string fixed at its ends is 70 cm long. The speed of transverse wave through it is 49 m s^{-1} . If the string is vibrating in seven identical segments

- (i) How many nodes and antinodes are present in its vibration?**
- (ii) What is the wavelength of the wave?**
- (iii) What is the frequency of vibration?**
- (iv) What is the fundamental frequency and wavelength of fundamental vibration of the string?**
- (v) What is the wavelength and frequency in the second overtone?**
- (vi) What is the wavelength and frequency in the fourth mode of vibration?**

Length of string, $L = 70 \text{ cm} = 0.7 \text{ m}$

Speed of transverse wave, $v = 49 \text{ m s}^{-1}$

Number of segments = mode of vibration of the string

$n = 7$

(i) Number of antinodes = mode of vibration $n = 7$

Number of nodes = $n + 1 = 7 + 1 = 8$

(ii) The wavelength of the wave, $\lambda_n = \frac{2L}{n}$

$$\therefore \text{Wavelength } \lambda_n = \frac{2 \times 0.7}{7} = 0.2 \text{ m}$$

(iii) The frequency of vibration,

$$f_n = \frac{nv}{2L}$$

$$\therefore f_n = \frac{7 \times 49}{2 \times 0.7} = 245 \text{ Hz}$$

(iv) $f_n = n f_1$,

Hence the fundamental frequency of string, $f_1 =$

$$\frac{f_n}{n} = \frac{245}{7} = 35 \text{ Hz} \text{ wavelength of the fundamental}$$

$$\text{mode, } \lambda_1 = \frac{v}{f_1} = \frac{49}{35} = 1.4 \text{ m}$$

(Alternatively

$$f_1 = \frac{nv}{2L} = \frac{1 \times 49}{2 \times 0.7} = 35 \text{ Hz}$$

$$\lambda_1 = \frac{2L}{n} = \frac{2 \times 0.7}{1} = 1.4 \text{ m}$$

(v) In the second overtone, the mode of vibration is

$$n = 3$$

$$\lambda_n = \frac{2L}{n} \text{ and}$$

$$f_n = nf_1$$

$$\lambda_3 = \frac{2 \times 0.7}{3} = 0.467 \text{ m}$$

The frequency of the second overtone,

$$f_3 = 3 f_1 = 3 \times 35 \\ = 105 \text{ Hz}$$

(vi) In the fourth mode of vibration, $n = 4$.

Frequency in the fourth mode of vibration,

$$f_4 = 4f_1 = 4 \times 35 = 140 \text{ Hz}$$

The wavelength of wave in the fourth mode,

$$\lambda_4 = \frac{2L}{n} = \frac{2 \times 0.7}{4} = 0.35 \text{ m}$$

Question

The air column in a closed pipe of length 40 cm and diameter 2.5 cm is set into vibration. What is the frequency of vibration if it is vibrating in its first mode? Velocity of sound in air $v = 340 \text{ m s}^{-1}$

Solution

Diameter of pipe = 2.5 cm = 0.025 m

End correction $e = 0.3 d = 0.3 \times 0.025 = 0.0075 \text{ m}$

Length of the pipe $L = 40 \text{ cm} = 0.40 \text{ m}$.

Frequency of vibration in the first mode

$$= \text{fundamental frequency, } f_1 = \frac{v}{4(L + e)}$$

$$= \frac{340}{4(0.40 + 0.0075)}$$

$$= \frac{340}{4 \times 0.4075}$$

$$= 208.59 \text{ Hz}$$

Question

A train moving at a speed of 72 kmph sounds a whistle of frequency 500 Hz. Calculate the apparent frequency of the whistle as heard by a man on the platform when the train (i) approaches him and (ii) recedes from him. Given speed of sound = 340 m s⁻¹.

Solution

Velocity of sound $v = 340 \text{ m s}^{-1}$

Velocity of source $v_s = 72 \text{ kmph}$

$$= \frac{72 \times 5}{18} = 20 \text{ m s}^{-1}$$

(i) **Apparent frequency of sound as heard by the listener.**

$$f' = f \frac{(v - v_L)}{(v - v_s)}$$

The train is approaching a stationary listener,

$$v_L = 0, v_s = + 20 \text{ m s}^{-1}$$

$$v = 340 \text{ m s}^{-1}, f = 500 \text{ Hz}$$

$$f' = f \frac{(v - v_L)}{(v - v_s)}$$

$$f' = \frac{500(340 - 0)}{(340 - 20)} = \frac{500 \times 340}{320} = 531.25 \text{ Hz}$$

(ii) The train is receding from a stationary listener.

$$v_L = 0, v_s = 20 \text{ m s}^{-1}$$

$$v = 340 \text{ m s}^{-1}, f = 500 \text{ Hz}$$

$$f' = f \frac{(v - v_L)}{(v + v_s)}$$

$$f' = \frac{500(340 - 0)}{(340 + 20)} = \frac{500 \times 340}{360} = 472.2 \text{ Hz}$$

Question

Find (i) the intensity level corresponding to sound intensity of 10^{-8} W m^{-2} and (ii) the intensity of sound of intensity level 50 dB. Given threshold of hearing = $10^{-12} \text{ W m}^{-2}$.

Solution

(i) Sound intensity $I = 10^{-8} \text{ W m}^{-2}$

Threshold of hearing $I_0 = 10^{-12} \text{ W m}^{-2}$

$$\text{Intensity level } I_L = 10 \log \left(\frac{I}{I_0} \right),$$

$$\text{dB} = 10 \log \left(\frac{10^{-8}}{10^{-12}} \right) = 10 \log 10^4 = 40 \text{ dB}$$

(ii) Intensity level $I_L = 50 \text{ dB}$

Intensity of sound = I

$$I_0 = 10^{-12} \text{ W m}^{-2}$$

$$I_L = 10 \log \left(\frac{I}{I_0} \right) \text{ dB}$$

$$50 = 10 \log \left(\frac{I}{I_0} \right)$$

$$\log \left(\frac{I}{I_0} \right) = 5, \frac{I}{I_0} = 10^5$$

$$I = 10^5 I_0, I = 10^5 \times 10^{-12}$$

$$\text{i.e., } I = 10^{-7} \text{ W m}^{-2}$$

Question

1. The displacement wave in a string is $y = (3 \text{ cm}) \sin 6.28(0.5x - 50t)$ where x is in centimetres and t in seconds. The wavelength and velocity of the wave is
- (a) 2 cm, 100 cm s^{-1} (b) 10 cm, 50 cm^{-1}
(c) 20 cm, 2 ms^{-1} (d) 2 m, 100 ms^{-1}

Solution (a) $k = \frac{2\pi}{\lambda}$

or $\lambda = \frac{2\pi}{k} = \frac{6.28}{6.28(0.5)} = 2 \text{ cm}$

$$v = \frac{\omega}{k} = \frac{50 \times 6.28}{0.5 \times 6.28} = 100 \text{ cm s}^{-1}$$

Question

2. The equation of a wave is $10 \sin(6.28x - 314t)$ where x is in centimetres and t is in seconds. The maximum velocity of the particle is
- (a) 62.8 cm s^{-1} (b) 3140 ms^{-1}
(c) 50 cm s^{-1} (d) 31.4 m s^{-1}

Solution (d) $y_{\text{max}} = \omega y_0 = 314(10) \text{ cm/s or } 31.4 \text{ ms}^{-1}$

3. The speed of a transverse wave travelling on a wire having a length 50 cm and mass 50 g is 80 ms^{-1} . The area of cross-section of the wire is 1 mm^2 and its Young's modulus is $16 \times 10^{11} \text{ Nm}^{-2}$. Find the extension of the wire over natural length.
- (a) 2 cm (b) 2 mm
(c) 0.2 mm (d) 0.02 mm

Solution (d) $v = \sqrt{\frac{T}{\mu}}$

or $T = v^2 \mu = (80)^2 \left(\frac{5}{0.5} \times 10^{-3} \right) = 64 \text{ N}$

and $Y = \frac{Fl}{A \Delta l}$

or $\Delta l = \frac{Fl}{AY} = \frac{64 \times 0.5}{10^{-6} \times 16 \times 10^{11}} = 2 \times 10^{-3} \text{ m.}$

4. Which of the following waves is progressing in the y direction?

- (a) $x = x_0 \cos(\omega t - ky)$ (b) $y = y_0 \cos(\omega t - ky)$
(c) $y = y_0 \cos kx \sin \omega t$ (d) $y = y_0 \sin kx \cos \omega t$

Solution (a) The wave $x = x_0 \cos(\omega t - ky)$ travels along y direction.

5. Velocity of sound in air is 332 m/s. Its velocity in vacuum is

- (a) $> 332 \text{ ms}^{-1}$ (b) $3 \times 10^8 \text{ ms}^{-1}$
(c) 332 ms^{-1} (d) none of these

Solution (d) None of these as velocity is zero as sound waves require medium.

6. A cork floating in a calm lake is executing SHM of frequency f . When a boat passes close to the cork then the

- (a) frequency becomes greater than f .
(b) frequency becomes less than f .
(c) frequency remains constant.
(d) none of these.

Solution (c) Frequency remains constant and velocity will vary, that is, wavelength will vary.

7. Two waves of equal amplitude x_0 and equal frequency travel in the same direction in a medium. The amplitude of the resultant wave is
- (a) 0 (b) x_0
(c) $2x_0$ (d) between 0 and $2x_0$

Solution (d) use $x_0' = \sqrt{x_{01}^2 + x_{02}^2 + 2x_{01}x_{02} \cos \theta}$

$\therefore \theta = 0$ and $x_{01} = x_{02} = x_0$
 $x_0' = 2x_0$

8. The fundamental frequency of a string is proportional to
- (a) inverse of the length. (b) the diameter.
(c) tension. (d) density.

Solution (a) $f \propto \frac{1}{l}$

9. A uniform rope of length 12 m and mass 6 kg hangs vertically from a rigid support. A block of mass 2 kg is attached to the free end of the rope. A transverse pulse of wavelength 0.06 m is produced at the lower end of the rope. What is the wavelength of the pulse when it reaches the top of the rope.
- (a) 0.06 m (b) 0.12 m
(c) 0.09 m (d) none of these

[IIT 1984]

Solution (d) $v = \frac{T}{\mu}$

$$\frac{v_{top}}{v_{bottom}} = \sqrt{\frac{T_T}{T_B}} = \sqrt{\frac{(6+2)g}{2g}} = 2$$

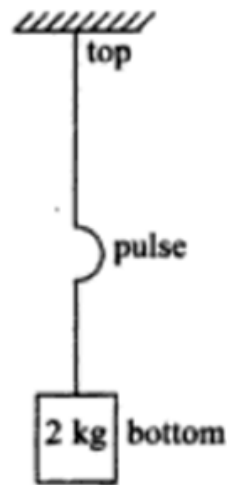

$$\frac{f\lambda_{\text{Top}}}{f\lambda_{\text{Bottom}}} = 2 \text{ as frequency does not change}$$

$$\therefore \lambda_{\text{top}} = \lambda_{\text{bot}} \times 2 = 0.12 \text{ m.}$$

- 10.** A uniform rope of mass 0.1 kg and length 2.45 m hangs from a ceiling. The speed of transverse waves in the rope at a point 0.5 m from the lower end is
- (a) 2.21 ms^{-1} (b) 4.21 ms^{-1}
(c) 7.21 ms^{-1} (d) 3.31 ms^{-1}

Solution (a) $T = \frac{M}{L} (x)g$

and $v = \sqrt{\frac{\frac{M}{L} (x)g}{M/L}} = \sqrt{gx} = \sqrt{9.8 \times 0.5}$
 $= 2.21 \text{ m/s}$

11. The equations of motion of two waves propagating in the same direction is given by

$$y_1 = A \sin(\omega t - kx)$$

and $y_2 = A \sin(\omega t - kx - \theta).$

The amplitude of the medium particle will be

(a) $\sqrt{2} A \cos \theta$

(b) $2A \cos \theta$

(c) $\sqrt{2} A \cos \theta/2$

(d) $2A \cos \theta/2$

13. A steel wire of linear mass density 9.8 g/m is stretched with a tension of 10 kg. It is kept between poles of an electromagnet and it vibrates in resonance when carrying an arc of frequency n . The frequency n is

(a) 100 Hz

(b) 200 Hz

(c) 25 Hz

(d) 50 Hz

Solution (d) $f = \frac{1}{2l} \sqrt{\frac{T}{\mu}} = \frac{1}{2} \sqrt{\frac{10 \times 9.8}{9.8 \times 10^{-3}}}$

$$= \frac{10^2}{2} = 50 \text{ Hz.}$$

14. The equation of a progressive wave is

$$y = 8 \sin \left[\pi \left(\frac{t}{10} - \frac{x}{4} \right) + \frac{\pi}{3} \right]. \text{ The wavelength}$$

of the wave is

(a) 8 m

(b) 4 m

(c) 2 m

(d) 10 m

Solution (a) $\frac{2\pi}{\lambda} = k$ or $\lambda = \frac{2\pi}{k} = \frac{2\pi}{\pi/4} = 8$

15. The equation of a stationary wave is $y = \sin \frac{\pi x}{3} \cos 10\pi t$ where x and y are in centimetres and t in seconds. The separation between two consecutive nodes is

(a) 1.5 cm

(b) 6.0 cm

(c) 3.0 cm

(d) 18 cm

Solution (c) $\lambda = \frac{2\pi}{k} = \frac{2\pi}{\pi/3} = 6$ cm.

Separation between two consecutive nodes
 $= \lambda/2 = 3$ cm.

17. An observer on the sea shore observes 54 waves reaching the coast per minute. If the wavelength is 10 m. The velocity is

- (a) 9 ms^{-1} (b) 54 ms^{-1}
(c) 18 ms^{-1} (d) 36 ms^{-1}

Solution (a) $f = \frac{54}{60} = \frac{9}{10} \text{ Hz}$

$$v = f\lambda = \frac{9}{10} \times 10 = 9 \text{ ms}^{-1}$$

18. A light pointer fixed to one prong of a tuning fork touches a vertical smoked plate. The fork is set to vibration and the plate is allowed to fall freely. Eight

complete waves are counted when the plate falls through 10 cm. The frequency of the tuning fork is

- (a) 112 Hz (b) 14 Hz
(c) 28 Hz (d) 56 Hz

[IIT 1996]

Solution (d) $t = \sqrt{\frac{2h}{g}} = \sqrt{\frac{2 \times 0.1}{9.8}} = \frac{1}{7} \text{ s.}$

$$f = \frac{\text{number of waves}}{\text{time}} = \frac{8}{1/7} = 56 \text{ Hz.}$$

19. A progressive wave of frequency 500 Hz is travelling with a velocity 360 ms^{-1} . How far are two points 60° out of phase?

(a) 0.06 m

(b) 0.12 m

(c) 0.18 m

(d) 0.24 m

Solution (b) $\lambda = \frac{v}{f} = \frac{360}{500} = 0.72 \text{ m}$

$$\Delta\phi = \frac{2\pi}{\lambda} (\Delta x)$$

or $\Delta x = \frac{\Delta\phi\lambda}{2\pi} = \frac{\pi/3(0.72)}{2\pi} = 0.12 \text{ m}$

20)

Two blocks each having a mass 3.2 kg are connected by a wire CD and the system is suspended from the ceiling by another wire AB as shown in figure. The linear mass density of AB is 10 gm^{-1} and that of the CD is 8 gm^{-1} . The speed of the transverse wave pulse produced in AB and CD is

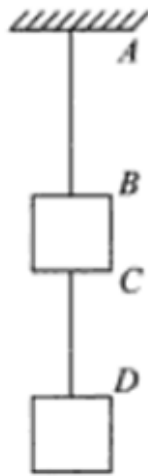

- (a) 80 ms^{-1} , 40 ms^{-1} (b) 40 ms^{-1} , 80 ms^{-1}
(c) 80 ms^{-1} , 63 ms^{-1} (d) none of these

Solution (c) $v = \sqrt{\frac{T}{\mu}} \Rightarrow v_{AB}$

$$= \sqrt{\frac{6.4 \times 10}{10 \times 10^{-3}}} = 80 \text{ ms}^{-1}$$

$$v_{CD} = \sqrt{\frac{3.2 \times 10}{8 \times 10^{-3}}} = 63 \text{ ms}^{-1}$$

Question (Passage type)

Your roommates have lost the TV remote control and no amount of searching can find it. Rather than buy a new one, you build a low cost replacement. You attach one end of a small lever mechanism to the TV channel changing button. You plan to attach the other end of the lever to a 3 m long string that will run from TV to the couch. When you pull the string tight and pluck your end of the string a wave will travel down the string and trigger the lever, changing the channel. Your design assumes you will disturb the string vertically by 5 mm when you pluck it and that your wave will take only 0.2 s to travel horizontally along the string from your end to the lever. Unfortunately you could not find a single string 3 m long. You could only find two 1.5 m long strings one weighing 90 g and the other weighing 10 g You tie the two pieces to make a 3 m long string and attach one end of the combined string to lever mechanism. You then take the other end in hand and head for the couch.

1. How hard do you have to pull to make it stretch taut?
(a) 7.5 N (b) 75 N
(c) 1.5 N (d) 13.5 N
2. How many loops will be seen in each string?
(a) 1 in thinner wire and three in thicker wire.
(b) 3 in thinner wire and 1 in thicker wire.
(c) 1 each.
(d) 3 each.
3. What is the frequency of the wave?
(a) 21.5 Hz (b) 20 Hz
(c) 14.3 Hz (d) 11.1 Hz

Solution 1. (a) $v = \sqrt{\frac{T}{\mu}} \Rightarrow \frac{3}{0.2} = \sqrt{\frac{T}{.1}}$

or $3 T = 22.5 N$

or $T = 7.5 N$

Solution 2. (a) $f = \frac{n_1}{2l} \sqrt{\frac{T}{1.5}} = \frac{n_2}{2l} \sqrt{\frac{T}{.09}}$

or $\frac{n_1}{n_2} = \frac{1}{3}$

Solution 3. (d) $f = \frac{1}{3} \sqrt{\frac{7.5 \times 1.5}{.01}} = \sqrt{125} = 11.1 \text{ Hz.}$

Question

A boy of 5th standard is playing with the cloths line. He unties one end, holds it taut and wiggles the end up and down sinusoidlly with frequency 2 Hz and amplitude 0.075 m. The wave speed is 12 ms^{-1} . At $t = 0$ the end has maximum displacement and is instantaneously at rest. Assume no wave bounces back from the far end to muddle up the pattern.

1. What is wave number?

(a) 1.05 m^{-1} (b) 1.32 m^{-1}

(c) 0.78 m^{-1} (d) 2.34 m^{-1}

2. Write a wave function describing the wave.

(a) $y = 0.075 \cos (1.05x - 4\pi t)$

(b) $y = 0.075 \cos (1.05x - 2t)$

(c) $y = 0.075 \sin (1.05x - 4\pi t)$

(d) $y = 0.075 \sin (1.05x - 2t)$

3. Write equations for the displacement as a function of time 3 m of the boy's end of the clothesline

(a) $y = 0.075 \cos 4\pi$ (b) $y = (-0.075 \cos 4\pi)$

(c) $y = 0.075 \sin 4\pi$ (d) none

Solution 1. (a) $v = \frac{\omega}{k}$

or $k = \frac{\omega}{v} = \frac{2\pi \times 2}{12} = \frac{\pi}{3} = 1.05 \text{ m}^{-1}$.

Solution 2. (a)

Solution 3. (b) $y = y_0 \cos 2\pi \left(\frac{x}{\lambda} - \frac{t}{T} \right) = 0.075 \cos 2\pi$

$$\left(\frac{3}{6} - 2t \right)$$

$\therefore \lambda = \frac{v}{f} = \frac{12}{2} = 6 \text{ m.}$
 $= 0.075 \cos (\pi - 4\pi t)$
 $= -0.075 \cos 4\pi t$

Read the following passage and answer the questions given at the end.

One of the strings of a Guitar lies along the x -axis when in equilibrium. The end of the string at $x = 0$ (the bridge of the guitar) is tied down. An incident sinusoidal wave travels the string in the $-x$ direction at 143 ms^{-1} with an amplitude 0.75 mm and a frequency of 440 Hz . This wave is reflected from the $x = 0$ end (fixed end) and the super position of incident and reflected travelling waves forms a standing wave.

- The equation of the wave representing stationary wave is
 - $0.75 \sin 19.3x \cos 880\pi t$.
 - $(0.75 \times 10^{-3}) \sin 19.3x \cos 880\pi t$.
 - $1.5 \times 10^{-3} \sin 19.3x \cos 880\pi t$.
 - $1.50 \times 10^{-3} \sin 19.3x \cos 440\pi t$.
- The separation between the two nearest points on the string that donot move at all is
 - 0.163 m
 - 0.325 m
 - 0.202 m
 - 0.244 m
 - none

3. The maximum transverse velocity and maximum transverse acceleration at point of maximum oscillation is

- (a) $4.15 \text{ ms}^{-1}, 1.15 \times 10^4 \text{ ms}^{-2}$
- (b) $4.15 \text{ ms}^{-1}, -1.15 \times 10^4 \text{ ms}^{-2}$
- (c) $1.15 \text{ ms}^{-1}, 4.15 \times 10^4 \text{ ms}^{-2}$
- (d) $3.98 \text{ ms}^{-1}, 1.35 \times 10^4 \text{ ms}^{-2}$

Solution 1. (c) $y = 2y_0 \sin kx \cos \omega t = 1.5 \times 10^{-3} \sin$

$$\left(\frac{440 \times 2\pi}{143} x \right) \cos (440 \times 2\pi)t$$

Solution 2. (a) $l = \frac{\lambda}{2} = \frac{143}{2 \times 440} = 0.163 \text{ m.}$

Solution 3. (a) $v_{\max} = \left. \frac{\partial y}{\partial t} \right|_{\max} = 1.5 \times 10^{-3} \times 2760 \sin 19.3x$

$$\cos 880\pi t \Big|_{\max} = 4.15 \text{ ms}^{-1}$$

$$a_{\max} = \left. \frac{\partial^2 y}{\partial t^2} \right|_{\max} = 4.15 \times 2760 = 1.15 \times 10^4 \text{ ms}^{-2}$$

Question

Two open pipes of length 50 cm and 51 cm produce 6 beats when sounded together, find the speed of sound.

(a) 330 ms^{-1}

(b) 316 ms^{-1}

(c) 306 ms^{-1}

(d) 360 ms^{-1}

Solution (c) $f_1 - f_2 = 6$ or $\frac{v}{2l_1} - \frac{v}{2l_2} = 6$

$$\frac{v}{2(0.5)} - \frac{v}{2(0.51)} = 6 \text{ or } v = 306 \text{ ms}^{-1}.$$

Question

If fundamental frequency of an open pipe is f_0 . Its fundamental frequency when it is half-filled with water is

(a) f_0

(b) $\frac{\lambda}{4}$

(c) $2f_0$

(d) none of these

Solution (a) See the situation shown in the Fig.

When the pipe is half-filled with water it becomes a closed pipe and the length.

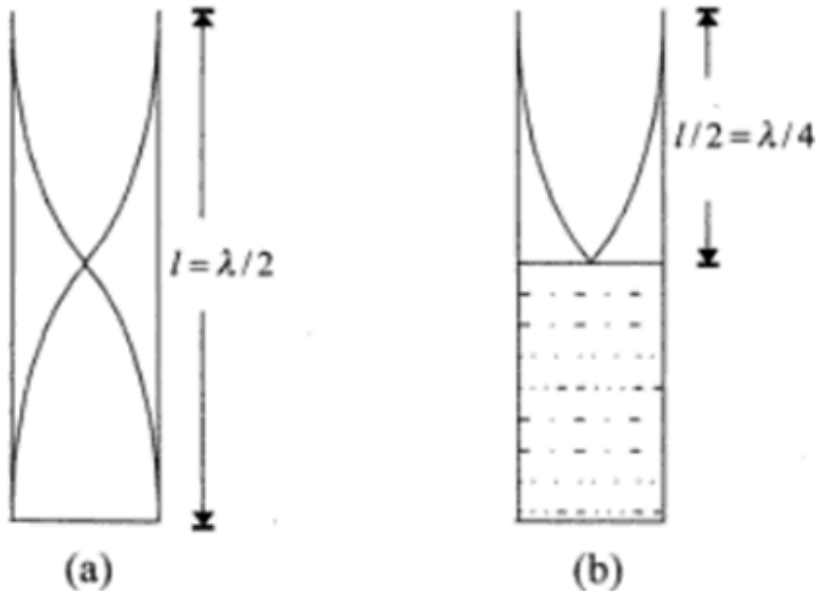

Fig.

$$\frac{l}{2} = \frac{\lambda}{4} \text{ or } \lambda = 2l$$

same wavelength existed in open pipe. Therefore,

frequency remains unchanged as $f = \frac{v}{\lambda}$.

Question

In the experiment for determination of the speed of sound in air using resonance tube method. The length of air column that resonates with fundamental mode

with a tuning fork is 0.1 m. When its length is changed to 0.35 m it resonates in first overtone. The end correction is

(a) 0.012 m

(b) 0.025 m

(c) 0.05 m

(d) 0.0024 m

Solution (b) $l_1 + 0.3 d = \frac{\lambda}{4}$, $l_2 + 0.3 d = \frac{3\lambda}{4}$;

$$\frac{\lambda}{2} = l_2 - l_1 = 0.25 \text{ m or } \frac{\lambda}{4} = 0.125 \text{ m}$$

$$0.3 d = \frac{\lambda}{4} - l_1 = 0.025 \text{ m}$$

Question

An observer moves towards a stationary source of sound with one-fifth of the speed of sound. The wavelength and frequency of the source emitted are λ and f respectively. The apparent frequency and wavelength recorded by the observer are

(a) $0.85f, 0.8 \lambda$

(b) $1.2f, 1.2 \lambda$

(c) $1.2f, \lambda$

(d) $f, 1.2 \lambda$

Solution (c) $f_{app} = \frac{v+v/5}{v} f = 1.2 f$ wavelength remains unchanged.

Question

An air column closed at one end and open at the other end resonates with a tuning fork when 45 and 99 cm of length. The wavelength of the sound in air column is

- (a) 36 cm (b) 54 cm
(c) 108 cm (d) 180 cm

Solution (c) $\frac{\lambda}{2} = 99 - 45 = 54 \text{ cm}$

or $\lambda = 108 \text{ cm}$

Question

The frequency of a tuning fork is 384 Hz and velocity of sound in air is 352 ms^{-1} . How far sound has travelled when fork completes 36 vibration?

- (a) 33 m (b) 16.5 m
(c) 11 m (d) 22 m

Solution (a) $x = v \cdot t = 352 \times \frac{36}{384} = 33 \text{ m.}$

-

Question

A sound source is falling under gravity. At some time $t = 0$ the detector lies vertically below source at a height H as shown in Fig. If v is velocity of sound and f_0 is frequency of the source then the apparent frequency recorded after $t = 2$ second is

Question

An open pipe is suddenly closed at one end. As a result the frequency of third harmonic of the closed pipe is found to be higher by 100 Hz. The fundamental frequency of open pipe is

(a) 200 Hz

(b) 30 Hz

(c) 240 Hz

(d) 480 Hz

[IIT 1996]

Solution (a) $f_{0(\text{closed})} = \frac{v}{\lambda} = \frac{v}{4l}$

third harmonic of closed pipe = $3f_{0(\text{closed})} = \frac{3v}{4l}$

$$\frac{3v}{4l} - \frac{v}{2l} = 100 \text{ or } \frac{v}{4l} = 100 \text{ and}$$

$$f_{0(\text{open})} = \frac{v}{2l}$$

$$\frac{v}{2l} = 200.$$

Question

As a wave propagates

- (a) the wave intensity remains constant for a plane wave.
- (b) the wave intensity decreases as the inverse of the distance from source for a spherical wave.
- (c) the wave intensity falls as the inverse square of the distance from a spherical wave.
- (d) total intensity of the spherical wave over the spherical surface centred at the source remains constant at all times.

Solution a, c, d

-

Question

Two monatomic ideal gases 1 and 2 of molecular masses m_1 and m_2 respectively are enclosed in separate containers kept at the same temperature. The ratio of the speed of sound in gas 1 to gas 2 is given by

- (a) $\frac{m_1}{m_2}$
- (b) $\sqrt{\frac{m_1}{m_2}}$
- (c) $\frac{m_2}{m_1}$
- (d) $\sqrt{\frac{m_2}{m_1}}$

[IIT 2000]

Solution (d) As $v = \sqrt{\frac{\gamma RT}{M}} \therefore \frac{v_1}{v_2} = \sqrt{\frac{m_2}{m_1}}$

Question

A siren placed at a railway platform is emitting sound of frequency 5 kHz. A passenger sitting in a moving train *A* records a frequency of 5.5 kHz when the train approaches the siren. During his return journey in a different train *B* he records the frequency of 6 kHz while approaching the same siren. The ratio of velocity of train *B* to train *A* is

(a) $\frac{242}{252}$

(b) $\frac{5}{6}$

(c) 2

(d) $\frac{11}{6}$

[IIT screening 2002]

Solution (c) $\left(\frac{v+v_{L1}}{v}\right)5 = 5.5, \left(\frac{v+v_{L2}}{v}\right)5 = 6$

or $\frac{v_{L1}}{v} = 0.5$ or $\frac{v_{L2}}{v} = 1$ or $\frac{v_{L2}}{v_{L1}} = 2$

Question

A piezo electric quartz crystal of thickness 0.005 m is vibrating in resonate conditions. Calculate the fundamental frequency f_0 for quartz.

$$Y = 8 \times 10^{10} \text{Nm}^{-2} \text{ and } \rho = 2.65 \times 10^3 \text{kgm}^{-3}$$

(a) 5.5 MHz

(b) 55 MHz

(c) 0.55 MHz

(d) 5.5 kHz

Solution (c) $v = \sqrt{\frac{Y}{\rho}} = \sqrt{\frac{8 \times 10^{10}}{2.69 \times 10^3}}$

$$= 5.5 \times 10^3 \text{ms}^{-1};$$

$$f = \frac{v}{\lambda} = \frac{5.5 \times 10^3}{2 \times 0.005} = 5.5 \times 10^5 \text{Hz.}$$

Question

Calculate the ratio of speed of sound wave in Neon to that in H_2O vapours at any temperature.

(a) $\frac{9}{8}$

(b) $\frac{3}{2\sqrt{2}}$

(c) $\frac{3}{2}$

(d) $\frac{8}{9}$

Solution

$$\begin{aligned} \text{(b) } \frac{v_{Ne}}{v_{H_2O}} &= \sqrt{\frac{\gamma_{Ne} M_{H_2O}}{M_{Ne} \gamma_{H_2O}}} \\ &= \sqrt{\frac{5/3 \times 18}{4/3 \times 20}} = \sqrt{\frac{9}{8}} = \frac{3}{2\sqrt{2}} \end{aligned}$$

Question

Find the speed of sound in a mixture of 1 mole of He and 2 mole of O₂ at 27°C.

- (a) 480 ms⁻¹ (b) 621 ms⁻¹
(c) 401 ms⁻¹ (d) 601 ms⁻¹

[IIT 1995]

Solution (c) $M_{\text{mix}} = \frac{n_1 M_1 + n_2 M_2}{n_1 + n_2}$

$$= \frac{1 \times 4 + 2 \times 32}{1 + 2} = \frac{68}{3}$$

$$C_{V(\text{mixture})} = \frac{n_1 C_{V1} + n_2 C_{V2}}{n_1 + n_2} = \frac{\left(1 \times \frac{3}{2} + 2 \times \frac{5}{2}\right) R}{1 + 2}$$

$$= \frac{13}{6} R$$

$$C_{P(\text{mix})} = C_V + R = \frac{19}{6} R \text{ or } \frac{C_P}{C_V} = \frac{19}{13} R$$

$$v = \sqrt{\frac{19}{13} \times \frac{8.31 \times 300}{\frac{68}{3} \times 10^{-3}}} = 400.9 \text{ ms}^{-1}$$

Question

Two radio stations broadcast their programmes at the same amplitude A and at slightly different frequencies ω_1 and ω_2 respectively where $\omega_2 - \omega_1 = 1$ kHz. A detector receives the signals from the two stations simultaneously. It can only detect signals of intensity $> 2A^2$. Find the interval between successive maxima of the intensity of the signal received by the detector.

- (a) 2×10^{-3} s (b) 4×10^{-3} s
(c) 1.5×10^{-3} s (d) 10^{-3} s

Solution (d) $y_1 = A \sin 2\pi\omega_1 t$ and $y_2 = A \sin 2\pi\omega_2 t$

$$y = y_1 + y_2 = A \sin 2\pi\omega_1 t + A \sin 2\pi\omega_2 t$$

$$= 2A \sin 2\pi \frac{(\omega_2 + \omega_1)}{2} t \cos 2\pi \frac{(\omega_2 - \omega_1)}{2} t$$

$$A' = 2A \cos 2\pi \frac{(\omega_2 - \omega_1)}{2} t$$

$$= 2A \cos \pi(\omega_2 - \omega_1)t$$

$$I \propto A'^2 = 4A^2 \cos^2 \pi(\omega_2 - \omega_1)t$$

For I to be maximum $\cos \pi(\omega_2 - \omega_1)t = \pm 1$

or $\pi(\omega_2 - \omega_1)t = 0, \pi, 2\pi, \dots$

$$T = t_2 - t_1 = \frac{1}{\omega_2 - \omega_1}$$

$$= 10^{-3}\text{s.}$$

Question

Which of the following will pair up to produce stationary wave?

(a) $Z_1 = A \cos(kx - \omega t)$ (b) $Z_2 = A \cos(kx + \omega t)$

(c) $Z_3 = A \cos(kx - \omega t)$ (d) $Z_4 = A \cos(kx + \omega t)$

(a) 1 and 2 (b) 2 and 3

(c) 3 and 4 (d) 1 and 3

[IIT 1993]

Solution (a) The waves must be travelling in opposite directions and have same amplitude and same frequency.

Question

A quartz crystal is used to produce ultrasonic. The frequency will be inversely related to

(a) Young's modulus. (b) thickness.

(c) density. (d) length.

Solution (b) $f \propto 1/t$.

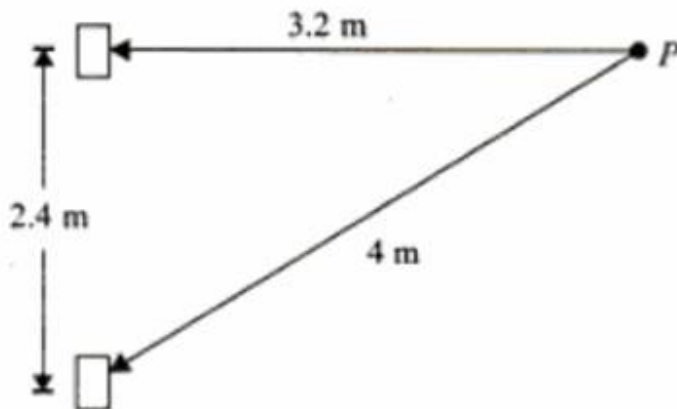

(a) $160(2n + 1)$

(b) $320(2n + 1)$

(c) $200(2n + 1)$

(d) $100(2n + 1)$

Solution (c) $\sqrt{3.2^2 + 2.4^2} = 4 \text{ m}$

$$\text{Path difference} = 0.8 \text{ m} = (2n + 1) \frac{\lambda}{2}$$

$$\lambda = \frac{1.6}{(2n + 1)} \text{ using } f = \frac{v}{\lambda} = \frac{320}{1.6} (2n + 1)$$

$$= 200(2n + 1) \text{ Hz.}$$

$$n = 1, 2, 3, \dots 49 \text{ are allowed.}$$

Question

A bullet passes past a person at a speed 220 ms^{-1} . Find the fractional change in the frequency of the whistling sound heard by the person as the bullet crosses the person. Speed of sound = 330 ms^{-1} .

(a) 0.67

(b) 0.8

(c) 1.2

(d) 3.0

Solution (b) Limiting cases when it is just at the verge of crossing and when it has just crossed are taken.

$$f_1 = \frac{v}{v + v_s} f = 0.6f \text{ and}$$

$$f_2 = \frac{v}{v - v_s} f = 3f$$

$$f_{\text{net}} = \frac{f_1 + f_2}{2} = \frac{3.6f}{2} = 1.8f$$

$$\Delta f = 0.8f \text{ or } \frac{\Delta f}{f} = 0.8.$$

Question

Horseshoe bats (genus *Rhinolophus*) emit sounds from their nostrils, then listen to the frequency of the sound reflected from their prey to determine the prey's speed. The horse shoe that gives the bat its name is a depression around the nostrils that acts like a focussing mirror so that the bat emits sound in a narrow beam like a flash light. A *Rhinolophus* is flying at a speed v_{bat} and emits sound of frequency f_{bat} ; the sound it hears reflected from an insect flying toward it has higher frequency f_{ref} . Speed of sound is v_s .

1. Find the speed of the insect $v_{insect} =$

$$(a) \quad v_s \left[\frac{f_{ref} (v_s - v_{bat}) - f_{bat} (v_s + v_{bat})}{f_{ref} (v_s - v_{bat}) + f_{bat} (v_s + v_{bat})} \right]$$

$$(b) \quad v_s \left[\frac{f_{ref} (v_s + v_{bat}) - f_{bat} (v_s - v_{bat})}{f_{ref} (v_s + v_{bat}) + f_{bat} (v_s - v_{bat})} \right]$$

$$(c) \quad v_s \left[\frac{f_{bat} (v_s + v_{bat}) - f_{ref} (v_s - v_{bat})}{f_{ref} (v_s - v_{bat}) + f_{bat} (v_s + v_{bat})} \right]$$

$$(d) \quad v_s \left[\frac{f_{ref} (v_s + v_{bat}) + f_{bat} (v_s - v_{bat})}{f_{ref} (v_s - v_{bat}) - f_{bat} (v_s + v_{bat})} \right]$$

Newton 's Law of Cooling by Prof. Subhashish Chattopadhyay SKMClasses Bangalore Useful for IIT-JEE, CBSE, I.Sc. PU-II, Boards, CET, CEE, PET, IGCSE IB AP-Physics and other exams

$$\begin{aligned}
 v_{in} & \left[(v_s + v_{bar}) + \frac{f_{ref}}{f_{bar}} (v_s - v_{bar}) \right] \\
 & = \frac{f_{ref}}{f_{bar}} v_s (v_s - v_{bar}) - v_s (v_s + v_{bar}) \\
 v_{in} & = v_s \left[\frac{\frac{f_{ref}}{f_{bar}} (v_s - v_{bar}) - (v_s + v_{bar})}{(v_s + v_{bar}) + \frac{f_{ref}}{f_{bar}} (v_s - v_{bar})} \right] \\
 & = v_s \left[\frac{f_{ref} (v_s - v_{bar}) - (v_s + v_{bar}) f_{bar}}{f_{bar} (v_s + v_{bar}) + f_{ref} (v_s - v_{bar})} \right]
 \end{aligned}$$

Solution . 2. (b)

$$2 = \left[\frac{83.5(340 - v_{bar}) - (340 + v_{bar})80.7}{80.7(340 + v_{bar}) + 83.5(340 - v_{bar})} \right]$$

solving for v_{bar} we get $v_{bar} = 3.9 \text{ ms}^{-1}$

Newton 's Law of Cooling by Prof. Subhashish Chattopadhyay SKMClasses Bangalore Useful for IIT-JEE, CBSE, I.Sc. PU-II, Boards, CET, CEE, PET, IGCSE IB AP-Physics and other exams

Question

When a sound wave enters the ear it sets the ear drum into oscillation, which in turn causes oscillation of the three tiny bones in the middle ear called the ossicles. This oscillation is finally transmitted to the fluid-filled inner ear. The motion of the fluid disturbs hair cells within the inner ear, which transmit nerve impulses to the brain with the information that a sound is present. The moving part of the eardrum has an area of about 43 mm^2 , and the area of the stirrup (The smallest of the ossicles) where it connects to the inner ear is about 3.2 mm^2 . A moderate loudness sound of maximum pressure variation are of the order of $3 \times 10^{-2} \text{ Pa}$ above and below atmospheric pressure of 10^5 Pa .

- Find the maximum displacement in the fluid of inner ear if frequency of the wave is 1 kHz. $v_{\text{fluid}} = 1500 \text{ ms}^{-1}$
 - $4.4 \times 10^{-11} \text{ m}$
 - $4.4 \times 10^{-10} \text{ cm}$
 - 4.4 A^0
 - 4.4 pm
- Find the pressure amplitude consider mass of the ossicles = 58 mg and Bulk modulus of fluid = $(45.8 \times 10^{-11})^{-1}$
 - 0.3 Pa
 - 0.4 Pa
 - 0.22 Pa
 - 0.8 Pa

Solution 1. (a) $R_{\text{inner ear}} = \frac{\omega}{v} = \frac{1000 \times 2\pi}{1500} = \frac{4\pi}{3}$

$$y_0 = \frac{P_{\text{max}}(\text{inner})}{B_{\text{fluid}} R_{\text{inner ear}}}$$

$$= \frac{0.4 \times 45 \times 10^{-11}}{\frac{4\pi}{3}} = 4.4 \times 10^{-11} \text{ m}$$

Solution 2. (b) $P_{\text{max}} = \frac{F_{\text{max}}}{\text{area of stirrup}}$

$$= \frac{3 \times 10^{-2} \times 43}{3.2} = 0.4 \text{ Pa}$$

Newton 's Law of Cooling by Prof. Subhashish Chattopadhyay SKMClasses Bangalore Useful for IIT-JEE, CBSE, I.Sc. PU-II, Boards, CET, CEE, PET, IGCSE IB AP-Physics and other exams

Bremsstrahlung Effect

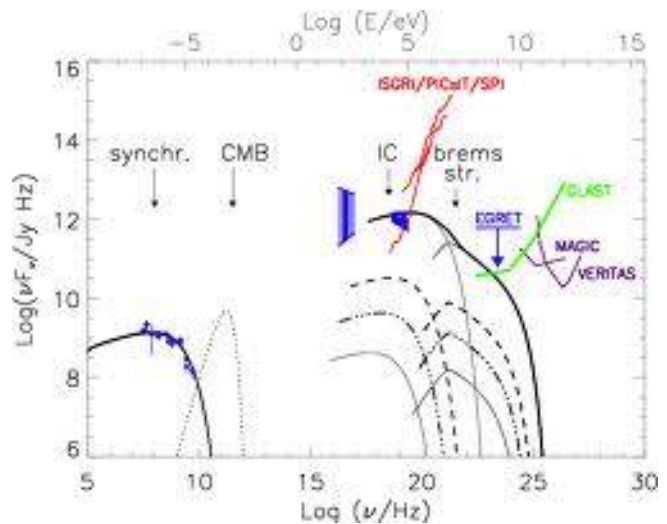
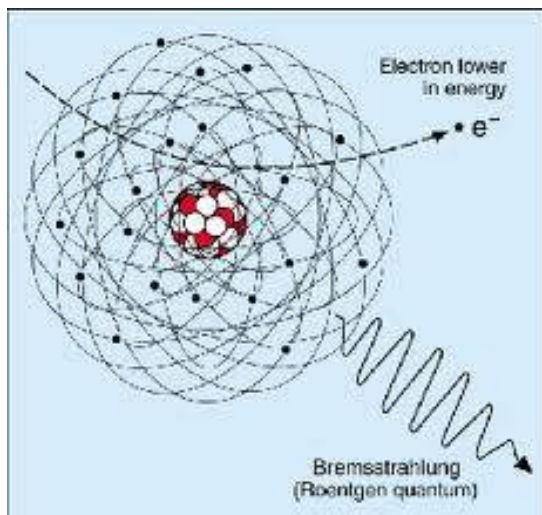
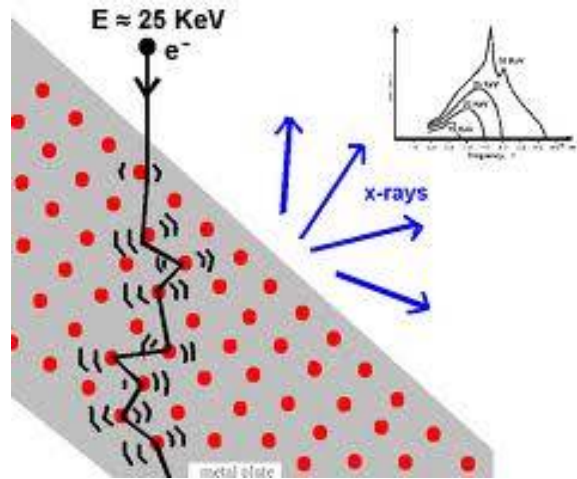
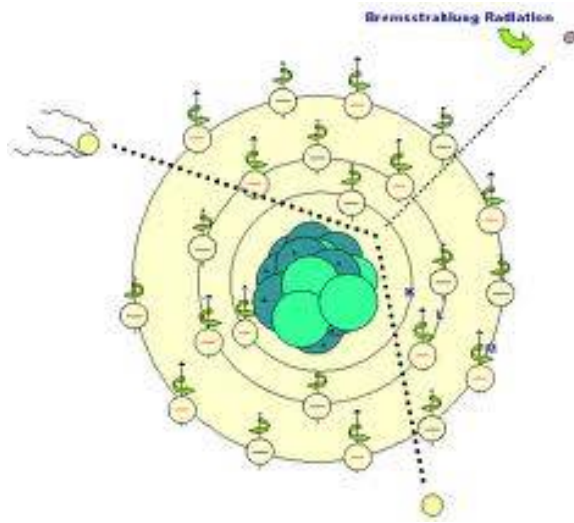

Newton 's Law of Cooling by Prof. Subhashish Chattopadhyay SKMClasses Bangalore Useful for IIT-JEE, CBSE, I.Sc. PU-II, Boards, CET, CEE, PET, IGCSE IB AP-Physics and other exams

Newton 's Law of Cooling by Prof. Subhashish Chattopadhyay SKMClasses Bangalore Useful for IIT-JEE, CBSE, I.Sc. PU-II, Boards, CET, CEE, PET, IGCSE IB AP-Physics and other exams

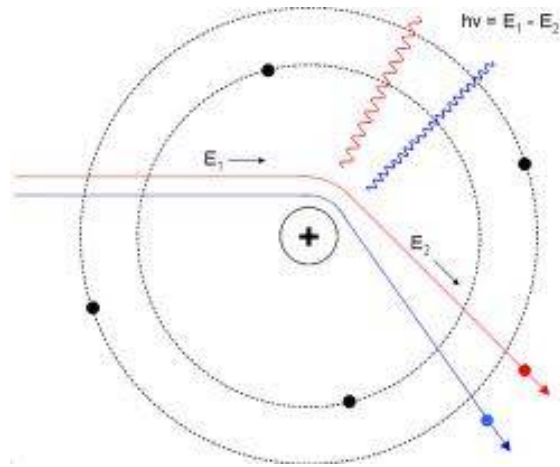
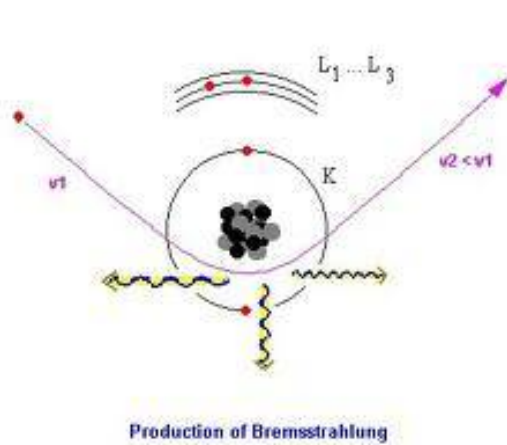

Bremsstrahlung radiation

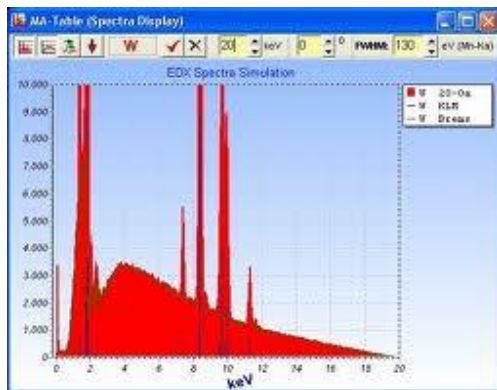
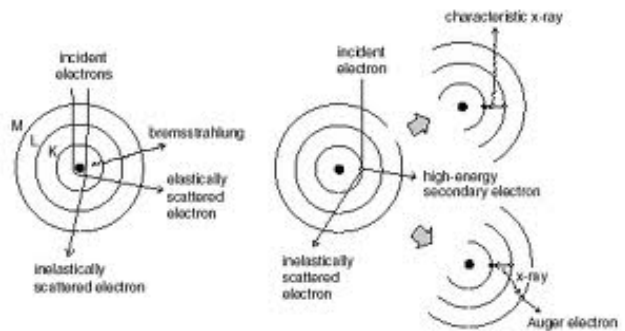
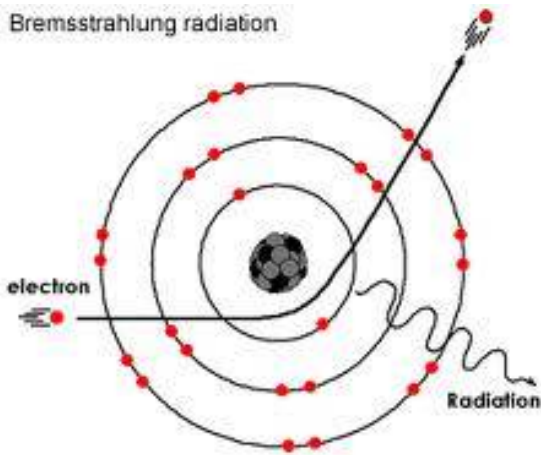

Penetrating Distances

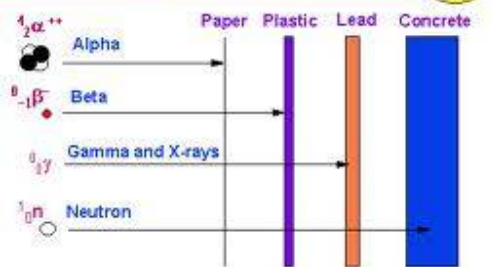

Newton 's Law of Cooling by Prof. Subhashish Chattopadhyay SKMClasses Bangalore Useful for IIT-JEE, CBSE, I.Sc. PU-II, Boards, CET, CEE, PET, IGCSE IB AP-Physics and other exams

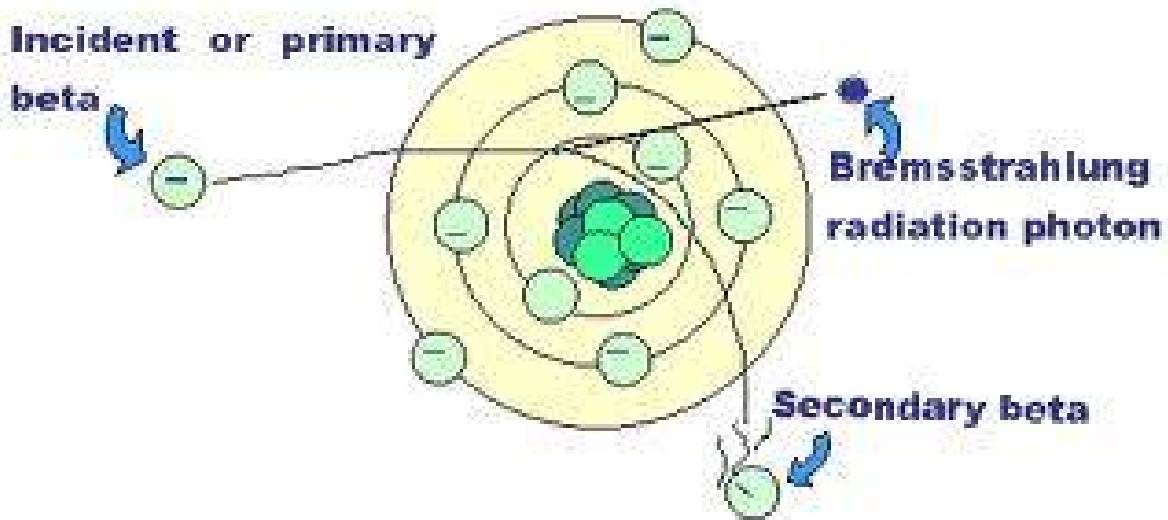

Bremsstrahlung (German word) from bremsen "to brake" and Strahlung "radiation", i.e. "braking radiation" or "deceleration radiation") is electromagnetic radiation produced by the deceleration of a charged particle when deflected by another charged particle, typically an electron by an atomic nucleus. The moving particle loses kinetic energy, which is converted into a photon because energy is conserved. The term is also used to refer to the process of producing the radiation. **Bremsstrahlung has a continuous spectrum**, which becomes more intense and shifts toward higher frequencies as the change of the energy of the accelerated particles increases.

Strictly speaking, bremsstrahlung is any radiation due to the acceleration of a charged particle, which includes **synchrotron radiation, cyclotron radiation, and the emission of electrons and positrons during beta decay**. However, the term is frequently used in the more narrow sense of radiation from electrons (from whatever source) stopping in matter.

Bremsstrahlung emitted from plasma is sometimes referred to as free-free radiation. This refers to the fact that the radiation in this case is created by charged particles that are free both before and after the deflection (acceleration) that causes the emission.

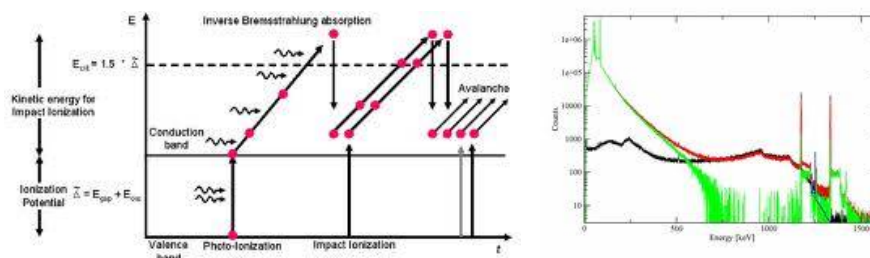

Equivalent Resistance in Infinite Mesh or Grid

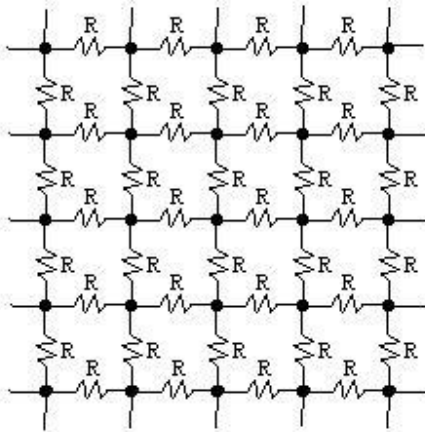

For Resistances R connected in square mesh or grid at any node current 1 Amp injected in any node will spread as $1/4$ Amp as in all directions. This is because, resistance in all directions are same. This current will go and assimilate at infinite radius. So a Battery positive terminal connected at a node and negative connected to infinite ring at edge will give current $1/4$ in adjacent resistances to the node. Similarly a Negative terminal of a battery connected to next node and positive terminal connected to infinite grid will also see $1/4$ in all adjacent resistances of the node. So as per superposition theorem the effective current in the resistance between the nodes is $1/4 + 1/4 = 1/2$ and thus equivalent resistance is $R/2$

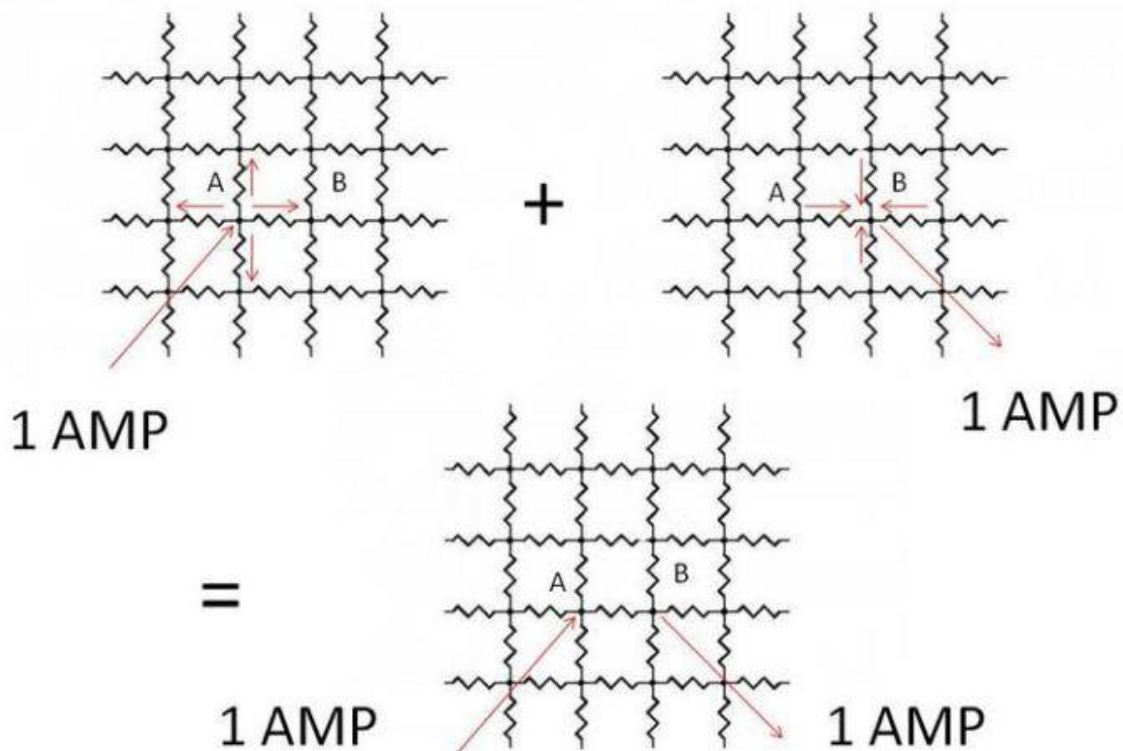

Newton 's Law of Cooling by Prof. Subhashish Chattopadhyay SKMClasses Bangalore Useful for IIT-JEE, CBSE, I.Sc. PU-II, Boards, CET, CEE, PET, IGCSE IB AP-Physics and other exams

The principle of superposition says that if we add the two solutions we also get a solution. Adding the two configurations above means that the resistor joining A to B must be carrying 1/2 Amp (1/4 from the first solution and 1/4 from the second, both in the same direction). But this is a 1Ω resistor so the Voltage across AB must be 1/2 V.

Think (or Imagine) the whole mesh or grid as being inside a black box in between the input wire and output wire. This black box has a current of 1 Amp flowing through it and the voltage dropped is 0.5 V. It's resistance is therefore 0.5 Ω. (For resistances of R the equivalent will come as R/2)

For Triangular mesh

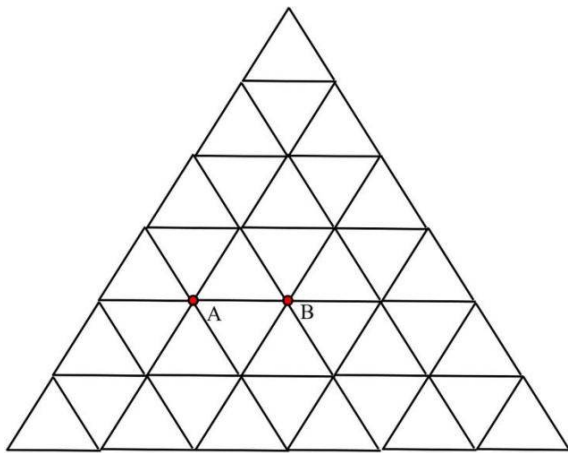

From node A; a current I injected will spread out in 6 directions equally. so I/6 will flow in each node, for positive of Battery being connected to A and negative connected to infinite ring away. Now again connect the Battery Negative to node B and positive terminal of the Battery to infinite ring away. So I/6 will flow again from A to B. Thus as per superposition theorem current in Branch A-B will be I/6 + I/6 = I/3 when Battery Positive terminal is connected to A and Battery negative is connected to B. Thus equivalent Resistance will come out to be R/3

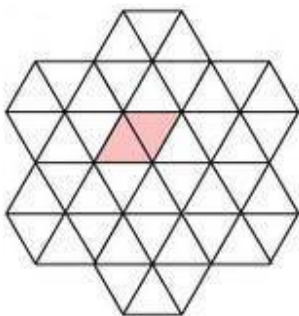

So let us discuss what happens in Hexagonal Honeycomb Resistances Infinite mesh or grid

Newton 's Law of Cooling by Prof. Subhashish Chattopadhyay SKMClasses Bangalore Useful for IIT-JEE, CBSE, I.Sc. PU-II, Boards, CET, CEE, PET, IGCSE IB AP-Physics and other exams

Newton 's Law of Cooling by Prof. Subhashish Chattopadhyay SKMClasses Bangalore Useful for IIT-JEE, CBSE, I.Sc. PU-II, Boards, CET, CEE, PET, IGCSE IB AP-Physics and other exams

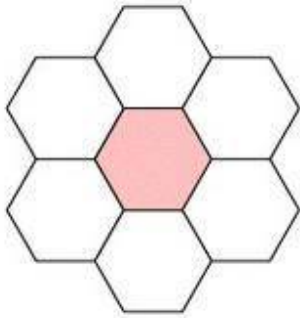

Here I will spread out as $I/3$ so when battery connected to adjacent nodes, the current in the resistance will be $2I/3$ thus equivalent resistance will be $2R/3$



Newton 's Law of Cooling by Prof. Subhashish Chattopadhyay SKMClasses Bangalore Useful for IIT-JEE, CBSE, I.Sc. PU-II, Boards, CET, CEE, PET, IGCSE IB AP-Physics and other exams

The V - i graph for a conductor at T₁ and T₂ are shown

The V-i graph for a conductor at temperatures T₁ and T₂ are as shown in the figure. (T₂-T₁) is proportional to -

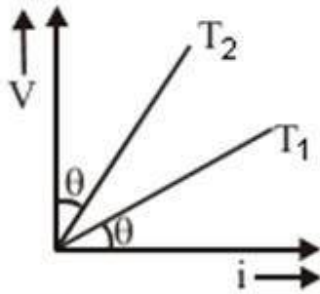

- (1) $\cos 2\theta$
- (2) $\sin \theta$
- (3) $\cot 2\theta$
- (4) $\tan \theta$

Ans : (3)

As we know, for conductors, resistance \propto temperature. From figure $R_1 \propto T_1 \Rightarrow \tan\theta \propto T_1$
 $\Rightarrow \tan\theta = kT_1$... (i)

and $R_2 \propto T_2 \Rightarrow \tan(90^\circ - \theta) \propto T_2$
 $\Rightarrow \cot\theta = kT_2$... (ii)

From equation (i) and (ii), $k(T_2 - T_1) = (\cot\theta - \tan\theta)$

$$(T_2 - T_1) = \left(\frac{\cos\theta}{\sin\theta} - \frac{\sin\theta}{\cos\theta} \right) = \left(\frac{(\cos^2\theta - \sin^2\theta)}{\sin\theta\cos\theta} \right)$$

$$= 2\cot 2\theta$$

$$\Rightarrow (T_2 - T_1) \propto \cot 2\theta$$

Hot wire Ammeter

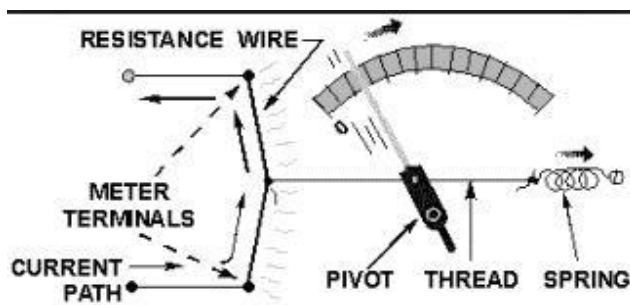

Thevenin's Theorem, Norton's Theorem, and Maximum Power Transfer

Question

Ideal *voltage sources* and ideal *current sources*, while both being sources of electrical power, behave very differently from one another:



Explain how each type of electrical source would behave if connected to a variable-resistance load. As this variable resistance were increased and decreased, how would each type of source respond?

[file 03226](#)

Answer

An ideal voltage source will output as much or as little current as necessary to maintain a constant voltage across its output terminals, for any given load resistance. An ideal current source will output as much or as little voltage as necessary to maintain a constant current through it, for any given load resistance.

A *voltage source* is a source of electricity that (ideally) outputs a constant voltage. That is, a perfect voltage source will hold its output voltage constant regardless of the load imposed upon it:

Ideal voltage sources assumed

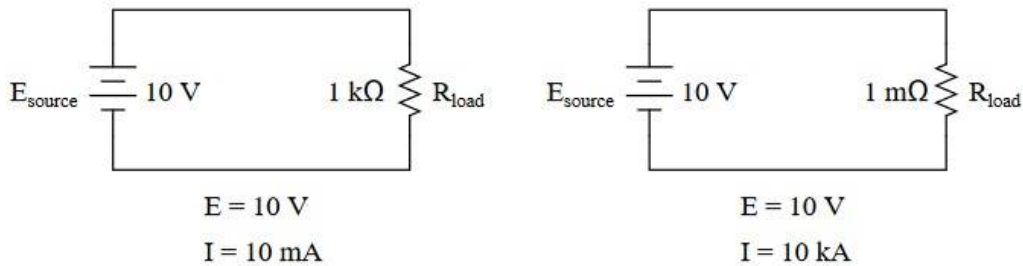

In real life, there is no such thing as a perfect voltage source, but sources having extremely low internal resistance come close.

Another type of electricity source is the *current source*, which (ideally) outputs a constant current regardless of the load imposed upon it. A common symbol for a current source is a circle with an arrow inside (always pointing in the direction of conventional flow, not electron flow!). Another symbol is two intersecting circles, with an arrow nearby pointing in the direction of conventional flow:

Current sources



Predict how an ideal current source would behave for the following two load scenarios:

Ideal current sources assumed

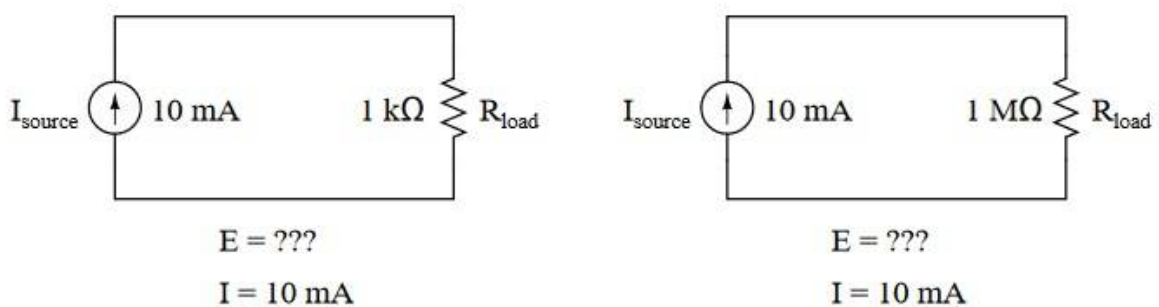

Ideal current sources assumed

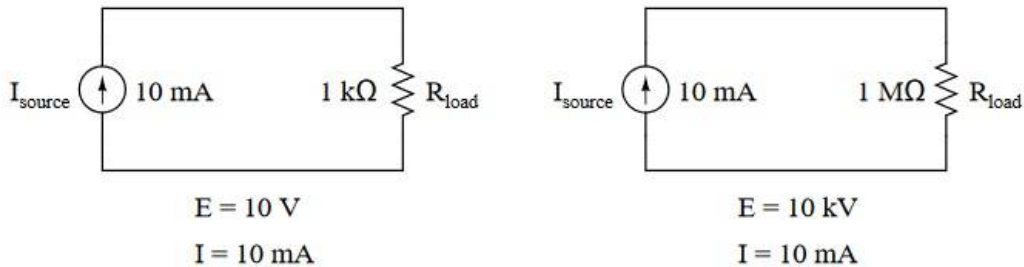

Follow-up question: identify the polarity of the voltage drops across the resistors in the circuits shown above.

What would happen if a wire having no resistance at all (0Ω) were connected directly across the terminals of a 6-volt battery? How much current would result, according to Ohm's Law?

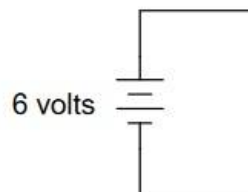

Suppose we were to short-circuit a 6-volt battery in the manner just described and measure 8 amps of current. Why don't the calculated figures from the previous paragraph agree with the actual measurement?

Ohm's Law would suggest an infinite current (current = voltage divided by zero resistance). Yet, the experiment described yields only a modest amount of current.

If you think that the wire used in the experiment is not resistance-less (i.e. it *does* have resistance), and that this accounts for the disparity between the predicted and measured amounts of current, you are partially correct. Realistically, a small piece of wire such as that used in the experiment will have a few tenths of an ohm of resistance. However, if you re-calculate current with a wire resistance of 0.1Ω , you will still find a large disparity between your prediction and the actual measured current in this short-circuit.

A very common sort of graph used in electronics work is the *load line*, showing all possibilities of load voltage and load current that a particular power source is able to supply to a load:

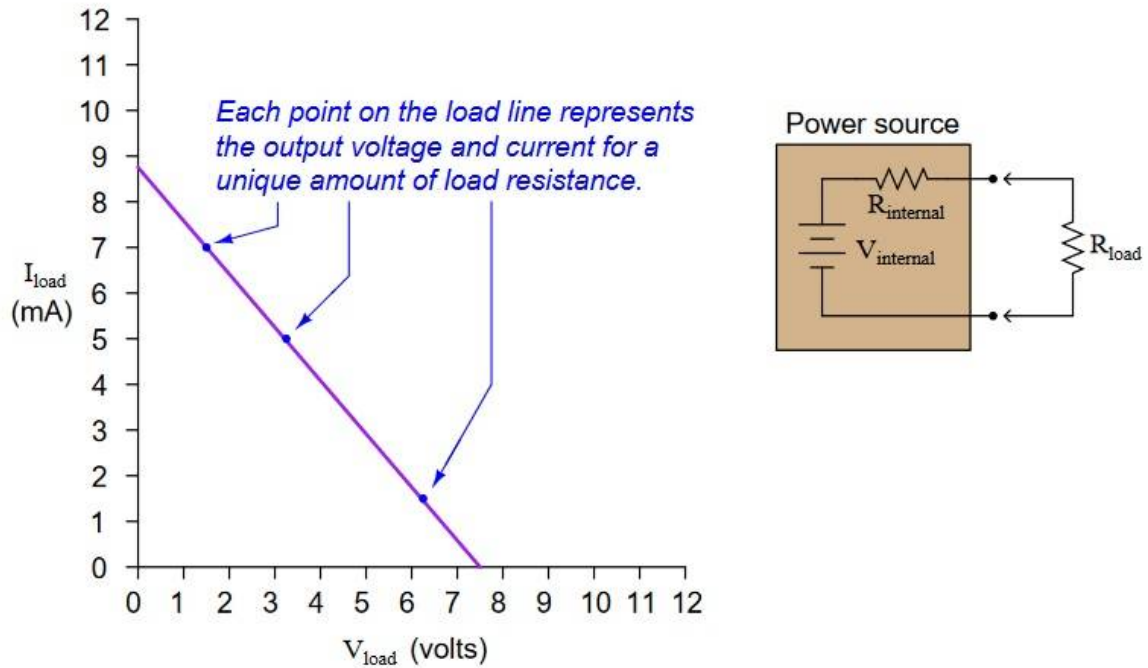

Note how the load line shows the voltage "sag" of the power source in relation to the amount of current drawn by the load. At high currents, the output voltage will be very low (upper-left end of load line). At low currents, the output voltage will be near its maximum (lower-right end of load line). If all internal components of the power source are *linear* in nature, the load line will always be perfectly straight.

Plot the load line for a power source having an internal voltage ($V_{internal}$) of 11 volts and an internal resistance ($R_{internal}$) of $1.2\text{ k}\Omega$. Superimpose your load line onto the load line graph shown above. Hint: it only takes two points to define a line!

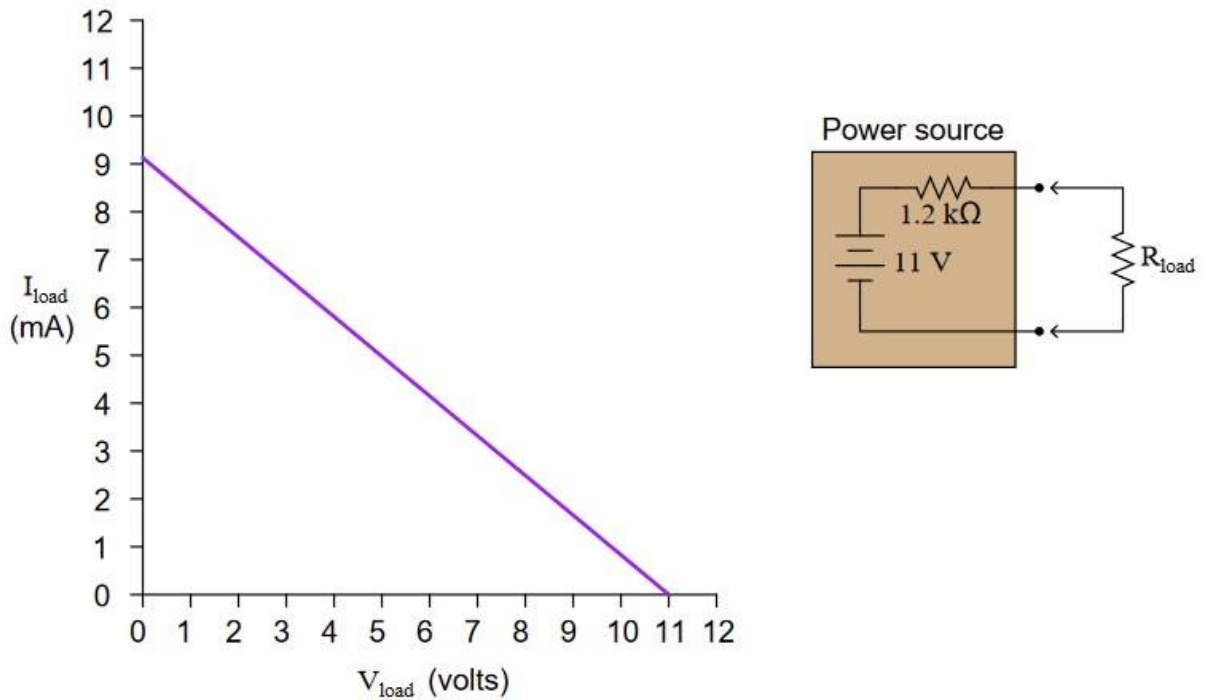

Hint: the easiest points to find on this load line are the points representing open-circuit and short-circuit conditions (i.e. $R_{load} = \infty\ \Omega$ and $R_{load} = 0\ \Omega$, respectively).

Follow-up questions: what will happen to the load line if we change the internal resistance of the power source circuit? What will happen to the load line if we change the internal voltage value of the power source circuit?

In the following circuit, an adjustable voltage source is connected in series with a resistive load and another voltage source:

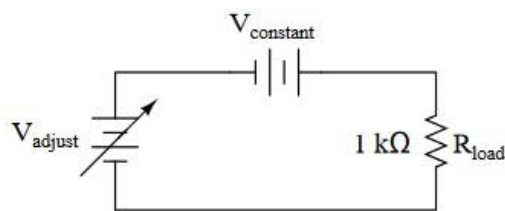

Determine what will happen to the current in this circuit if the adjustable voltage source is increased.

In this next circuit, an adjustable voltage source is connected in series with a resistive load and a *current* source:

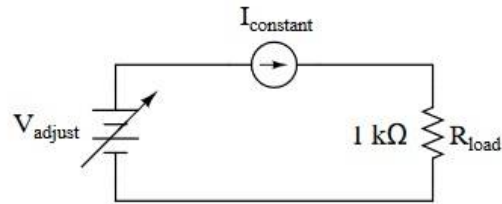

Now determine what will happen to the current in this second circuit if the adjustable voltage source is increased.

One way to define electrical resistance is by comparing the *change* in applied voltage (ΔV) to the *change* in resultant current (ΔI). This is mathematically expressed by the following ratio:

$$R = \frac{\Delta V}{\Delta I}$$

From the perspective of the adjustable voltage source (V_{adjust}), and as defined by the above equation, which of these two circuits has the greatest resistance? What does this result suggest about the equivalent resistance of a constant-voltage source versus the equivalent resistance of a constant-current source?

In the first circuit, current will increase as V_{adjust} is increased, yielding a finite total resistance. In the second circuit, current will remain constant as V_{adjust} is increased, yielding an infinite total resistance.

Follow-up question: calculate R as defined by the formula $\frac{\Delta V}{\Delta I}$ for these two circuits, assuming V_{adjust} changes from 15 volts to 16 volts (1 volt ΔV):

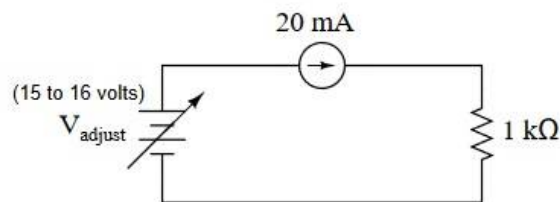
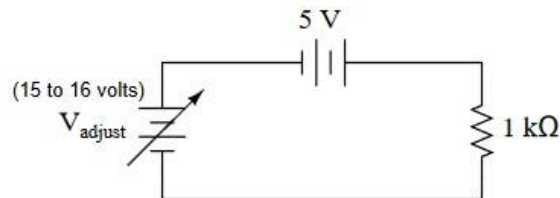

A practical *current source* may be built using a battery and a special semiconductor component known as a *current-limiting diode*:

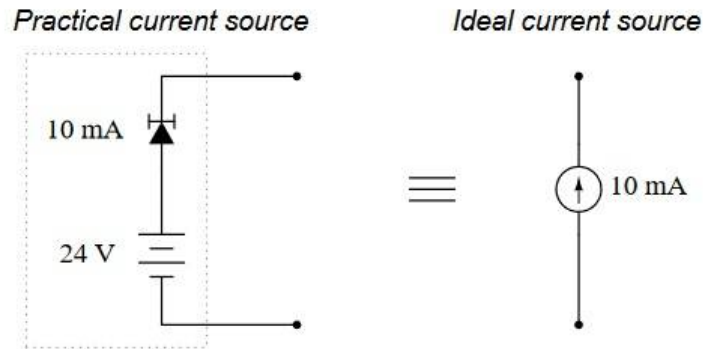

The current-limiting diode acts as a variable resistance, to regulate current through it at a constant value: if current increases, its resistance increases to reduce the current back to where it should be; if current decreases, its resistance decreases to increase current up to where it should be.

Determine the amount of voltage output by an open-circuited (ideal) current source. Contrast this with the voltage output by the practical current source shown in the diagram. Finally, draw an equivalent circuit showing an ideal current source somehow connected to a resistance in such a way that its open-circuited output voltage is identical to the practical current source.

An ideal current source outputs infinite voltage when open-circuited. The practical current source shown in the diagram outputs 24 volts.

Equivalent circuit:

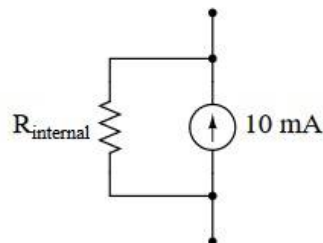

Suppose you were handed a black box with two metal terminals on one side, for attaching electrical (wire) connections. Inside this box, you were told, was a voltage source (an ideal voltage source connected in series with a resistance):

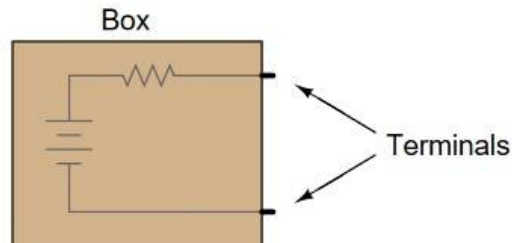

How would you experimentally determine the voltage of the ideal voltage source inside this box, and how would you experimentally determine the resistance of the series resistor? By "experimentally," I mean determine voltage and resistance using actual test equipment rather than assuming certain component values (remember, this "black box" is sealed, so you cannot look inside!).

Measure the open-circuit voltage between the two terminals, and then measure the short-circuit current. The voltage source's value is measured, while the resistor's value is calculated using Ohm's Law.

Suppose you were handed a black box with two metal terminals on one side, for attaching electrical (wire) connections. Inside this box, you were told, was a current source (an ideal current source connected in parallel with a resistance):

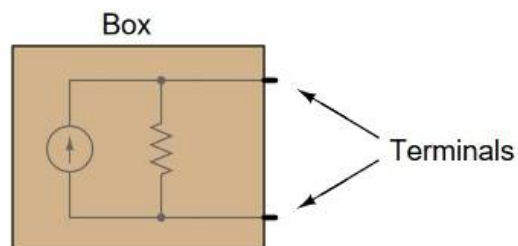

How would you experimentally determine the current of the ideal current source inside this box, and how would you experimentally determine the resistance of the parallel resistor? By "experimentally," I mean determine current and resistance using actual test equipment rather than assuming certain component values (remember, this "black box" is sealed, so you cannot look inside!).

Measure the open-circuit voltage between the two terminals, and then measure the short-circuit current. The current source's value is measured, while the resistor's value is calculated using Ohm's Law.

Load lines are special types of graphs used in electronics to characterize the output voltage and current behavior of different power sources:

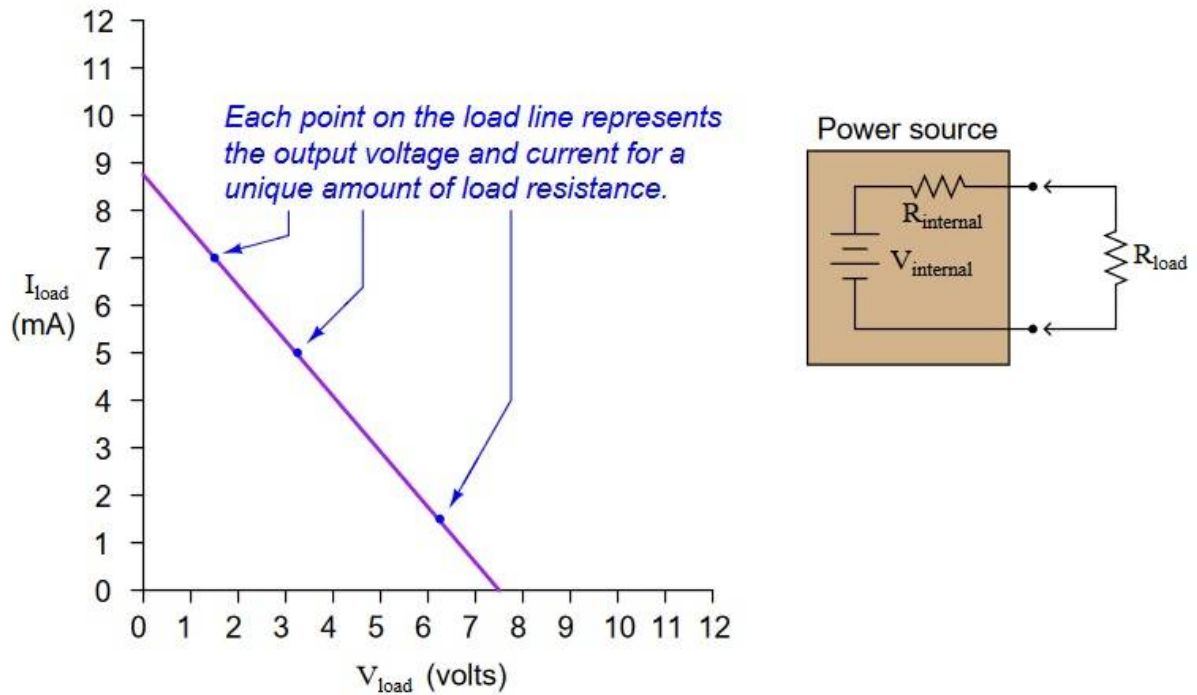

If we know that all the internal components of a power source are inherently *linear*, we know that the load line plot will indeed be a straight line. And, if we know the plot will be a straight line, all we need in order to plot a complete load line are *two* data points.

Usually, the easiest data points to gather for a circuit – whether it be a real circuit or an hypothetical circuit existing on paper only – is the *open-circuit* condition and the *short-circuit* condition. In other words, we see how much voltage the source will output with no load connected ($I_{load} = 0$ milliamps) and then we see how much current the source will output into a direct short ($V_{load} = 0$ volts):

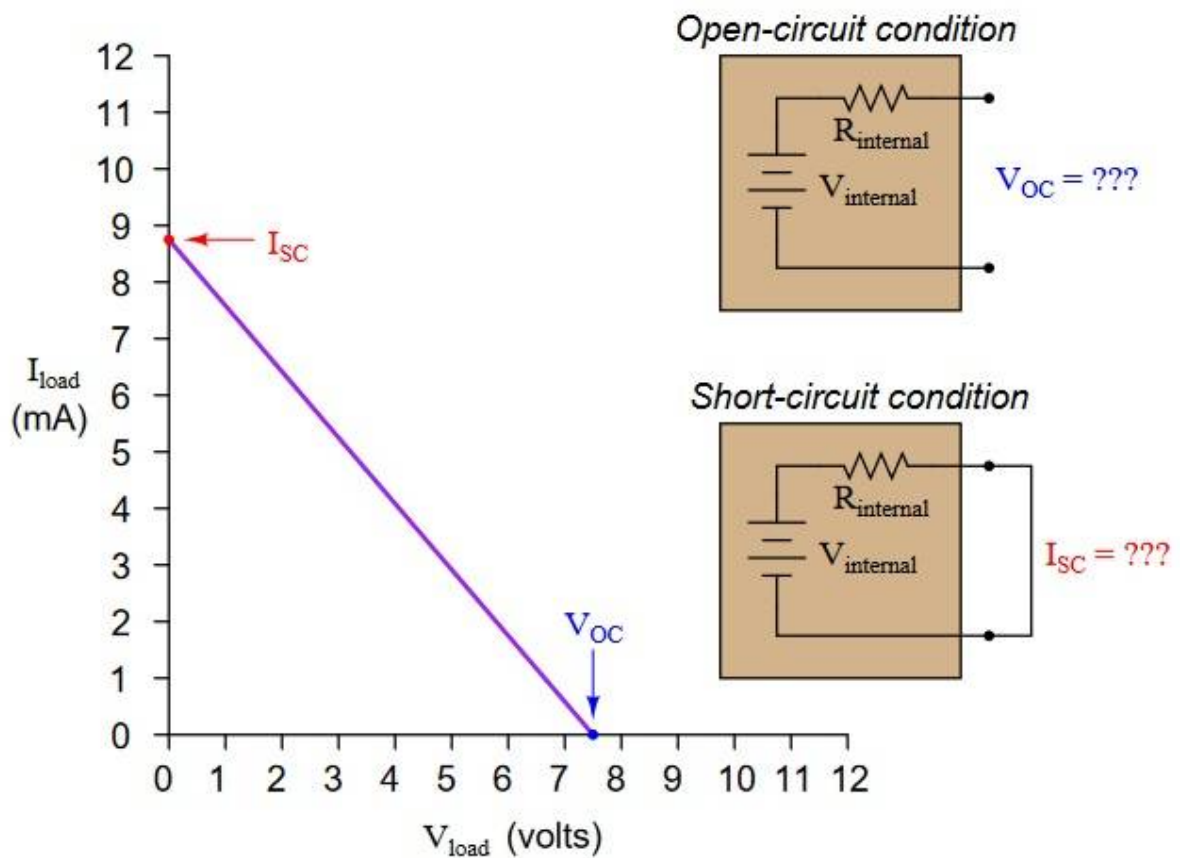

Suppose we have two differently-constructed power sources, yet both of these sources share the same open-circuit voltage (V_{oc}) and the same short-circuit current (I_{sc}). Assuming the internal components of both power sources are linear in nature, explain how we would know without doubt that the two power sources were electrically equivalent to one another. In other words, explain how we would know just from the limited data of V_{oc} and I_{sc} that these two power sources will behave exactly the same when connected to the same load resistance, whatever that load resistance may be.

How do we know these two power sources are completely equivalent to one another just from their equal open-circuit voltage and short-circuit current figures?

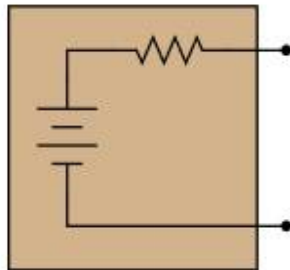

$V_{OC} = 7.5 \text{ volts}$
 $I_{SC} = 8.75 \text{ mA}$

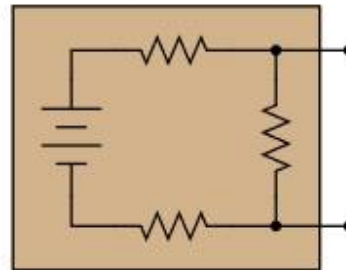

$V_{OC} = 7.5 \text{ volts}$
 $I_{SC} = 8.75 \text{ mA}$

With equal V_{OC} and I_{SC} figures and with linear componentry, the load lines must be identical. This means that *any* load resistance, when connected to each of the power sources, will experience the exact same voltage and current.

Suppose you were handed a black box with two metal terminals on one side, for attaching electrical (wire) connections. Inside this box, you were told, was a voltage source connected in series with a resistance.

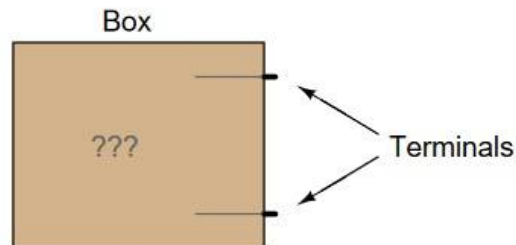

Your task was to experimentally determine the values of the voltage source and the resistor inside the box, and you did just that. From your experimental data you then sketched a circuit with the following component values:

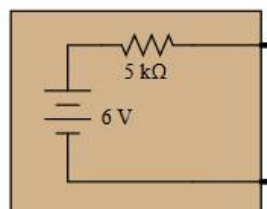

Newton 's Law of Cooling by Prof. Subhashish Chattopadhyay SKMClasses Bangalore Useful for IIT-JEE, CBSE, I.Sc. PU-II, Boards, CET, CEE, PET, IGCSE IB AP-Physics and other exams

However, you later discovered that you had been tricked. Instead of containing a single voltage source and a single resistance, the circuit inside the box actually looked like this:

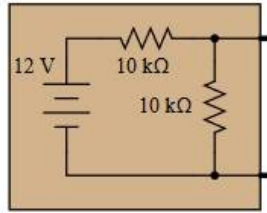

Demonstrate that these two different circuits are indistinguishable from the perspective of the two metal terminals, and explain what general principle this equivalence represents.

A good way to demonstrate the electrical equivalence of these circuits is to calculate their responses to identical load resistor values. The equivalence you see here is an application of *Thévenin's Theorem*.

Suppose you were handed a black box with two metal terminals on one side, for attaching electrical (wire) connections. Inside this box, you were told, was a voltage source connected in series with a resistance.

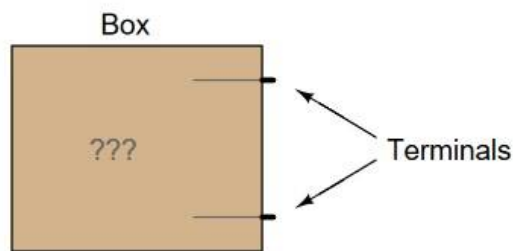

Your task was to experimentally determine the values of the voltage source and the resistor inside the box, and you did just that. From your experimental data you then sketched a circuit with the following component values:

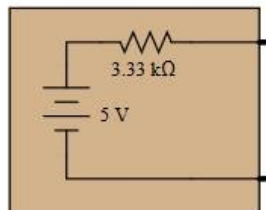

Newton 's Law of Cooling by Prof. Subhashish Chattopadhyay SKMClasses Bangalore Useful for IIT-JEE, CBSE, I.Sc. PU-II, Boards, CET, CEE, PET, IGCSE IB AP-Physics and other exams

Newton 's Law of Cooling by Prof. Subhashish Chattopadhyay SKMClasses Bangalore Useful for IIT-JEE, CBSE, I.Sc. PU-II, Boards, CET, CEE, PET, IGCSE IB AP-Physics and other exams

However, you later discovered that you had been tricked. Instead of containing a single voltage source and a single resistance, the circuit inside the box actually looked like this:

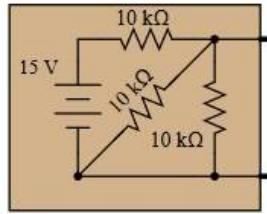

Demonstrate that these two different circuits are indistinguishable from the perspective of the two metal terminals, and explain what general principle this equivalence represents.

A good way to demonstrate the electrical equivalence of these circuits is to calculate their responses to identical load resistor values. The equivalence you see here is an application of Thevenin's Theorem

Examine this circuit, consisting of an ideal voltage source and several resistors

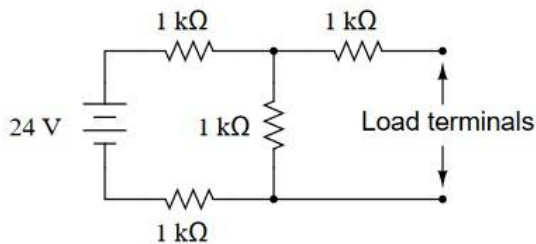

First, calculate the voltage seen at the load terminals with a voltmeter directly connected across them (an open-circuit condition)

Newton 's Law of Cooling by Prof. Subhashish Chattopadhyay SKMClasses Bangalore Useful for IIT-JEE, CBSE, I.Sc. PU-II, Boards, CET, CEE, PET, IGCSE IB AP-Physics and other exams

Newton 's Law of Cooling by Prof. Subhashish Chattopadhyay SKMClasses Bangalore Useful for IIT-JEE, CBSE, I.Sc. PU-II, Boards, CET, CEE, PET, IGCSE IB AP-Physics and other exams

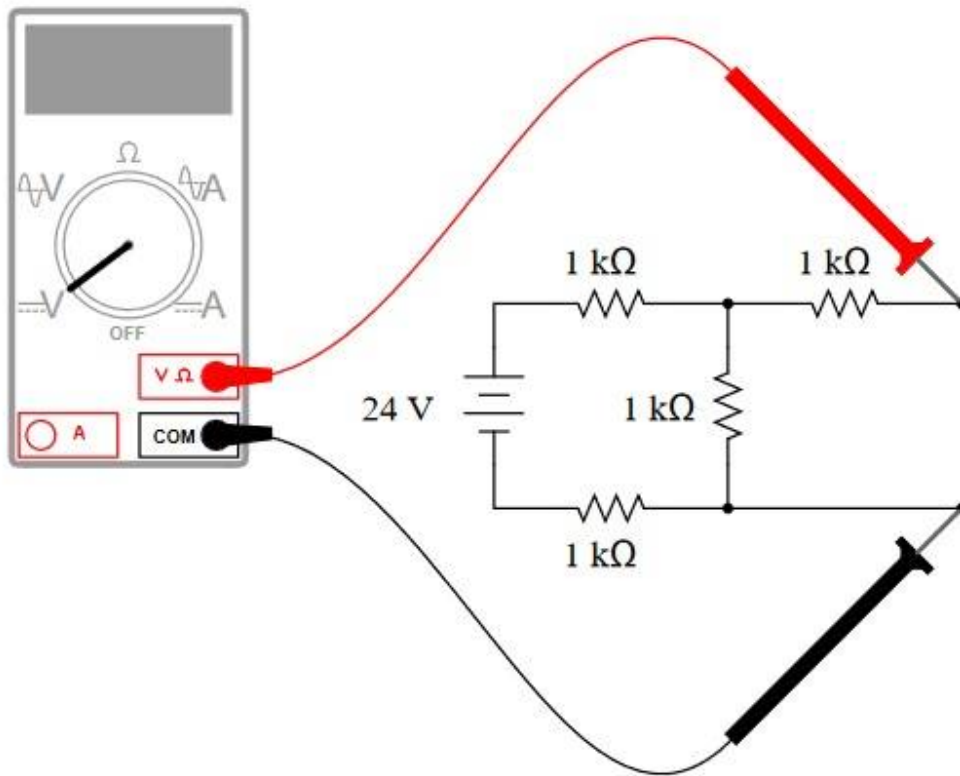

Next, calculate the current seen at the load terminals with an ammeter directly connected across them (a short-circuit condition)

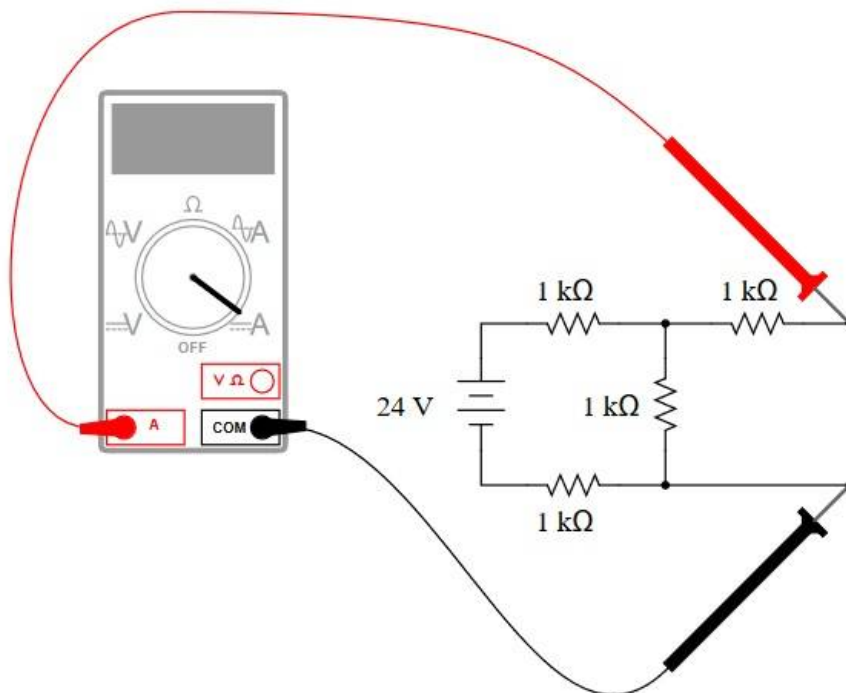

Newton 's Law of Cooling by Prof. Subhashish Chattopadhyay SKMClasses Bangalore Useful for IIT-JEE, CBSE, I.Sc. PU-II, Boards, CET, CEE, PET, IGCSE IB AP-Physics and other exams

Based on these open- and short-circuit calculations, draw a new circuit consisting of a single voltage source and a single (series) resistor that will respond in the exact same manner. In other words, design an *equivalent circuit* for the circuit shown here, using the minimum number of possible components.

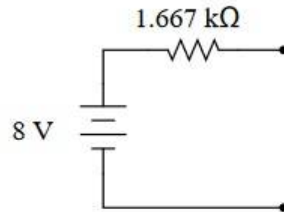

Follow-up question: is this circuit truly equivalent to the original shown in the question? Sure, it responds the same under extreme conditions (open-circuit and short-circuit), but will it respond the same as the original circuit under modest load conditions (say, with a 5 kΩ resistor connected across the load terminals)?

Suppose you were handed a black box with two metal terminals on one side, for attaching electrical (wire) connections. Inside this box, you were told, was a current source connected in parallel with a resistance.

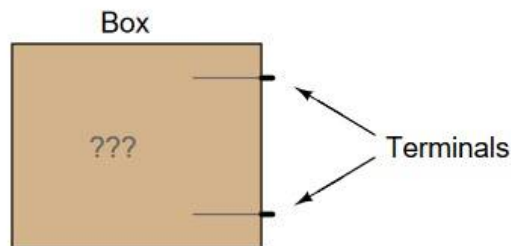

Your task was to experimentally determine the values of the current source and the resistor inside the box, and you did just that. From your experimental data you then sketched a circuit with the following component values:

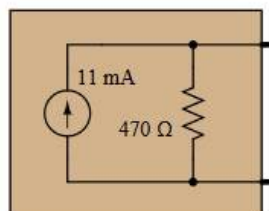

However, you later discovered that you had been tricked. Instead of containing a current source and a resistor, the circuit inside the box was actually a *voltage source* connected in *series* with a resistor:

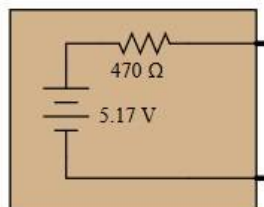

Demonstrate that these two different circuits are indistinguishable from the perspective of the two metal terminals, and explain what general principle this equivalence represents.

Newton 's Law of Cooling by Prof. Subhashish Chattopadhyay SKMClasses Bangalore Useful for IIT-JEE, CBSE, I.Sc. PU-II, Boards, CET, CEE, PET, IGCSE IB AP-Physics and other exams

A good way to demonstrate the electrical equivalence of these circuits is to calculate their responses to identical load resistor values. The equivalence you see here proves that Thévenin and Norton equivalent circuits are interchangeable.

Follow-up question: give a step-by-step procedure for converting a Thévenin equivalent circuit into a Norton equivalent circuit, and visa-versa.

An AC voltage source with an internal ("Thévenin") resistance of $50\ \Omega$ is connected to a step-down transformer with a winding ratio of 10:1. What is the equivalent source voltage and resistance, as seen from the load terminals?

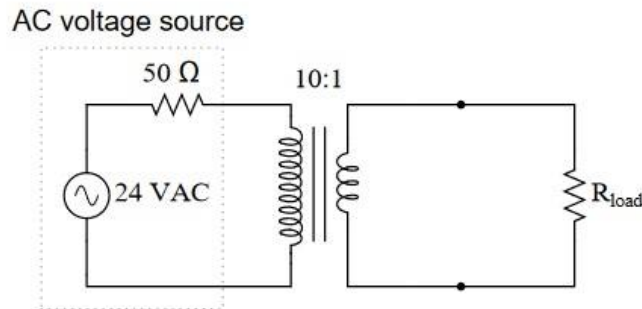

Equivalent source voltage = 2.4 VAC; equivalent source resistance = $0.5\ \Omega$.

(very Important) Concept of current Source IIT-JEE Karnataka-CET Circuits

<https://archive.org/details/6veryImportantConceptOfCurrentSourceIITJEEKarnatakaCETCircuitsPhy>

<https://archive.org/details/ConceptOfCurrentSourcePhysicsIITJEE1986CircuitAnalysisCapacitorPart2>

(very important) Delta to Star Conversion Electrical Circuits

<https://archive.org/details/6DeltaToStarConversionEquivalentResistanceOfUnbalancedWheatstoneBridgePhysics>

EAMCET-2000 Trick Questions in Electrical Circuits Internal Resistance of Battery

<https://archive.org/details/6EAMCET2000TrickQuestionsInElectricalCircuitsInternalResistanceOfBatteryIITJEEPhy>

Superposition Theorem

<https://archive.org/details/6SuperimpositionTheoremBranchCurrentIsSumOfIndividualCurrentsDueToEachBattery>

Electrical Circuits Step by Step

<https://archive.org/details/ElectricalCircuitsBasicsExplainedStepByStep1>

Newton 's Law of Cooling by Prof. Subhashish Chattopadhyay SKMClasses Bangalore Useful for IIT-JEE, CBSE, I.Sc. PU-II, Boards, CET, CEE, PET, IGCSE IB AP-Physics and other exams

Radius of Curvature of an Ellipse

Let us learn a few basic facts about Ellipse

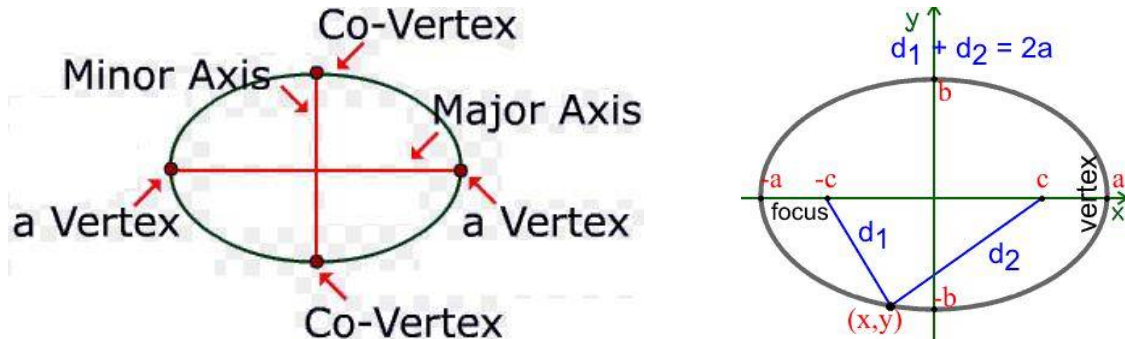

The major diameter is sometimes called the major axis. Let this have length $2*a$. Let the minor diameter (minor axis) have length $2*b$. We often say that a is the "semimajor axis" and that b is the "semiminor axis." Then the eccentricity of the ellipse is

$$e = \sqrt{a^2 - b^2} / a$$

This should be a number between 0 and 1. The distance from the center to the foci is $c = a*e = \sqrt{a^2 - b^2}$.

An Ellipse can be visualized as a Conic Section

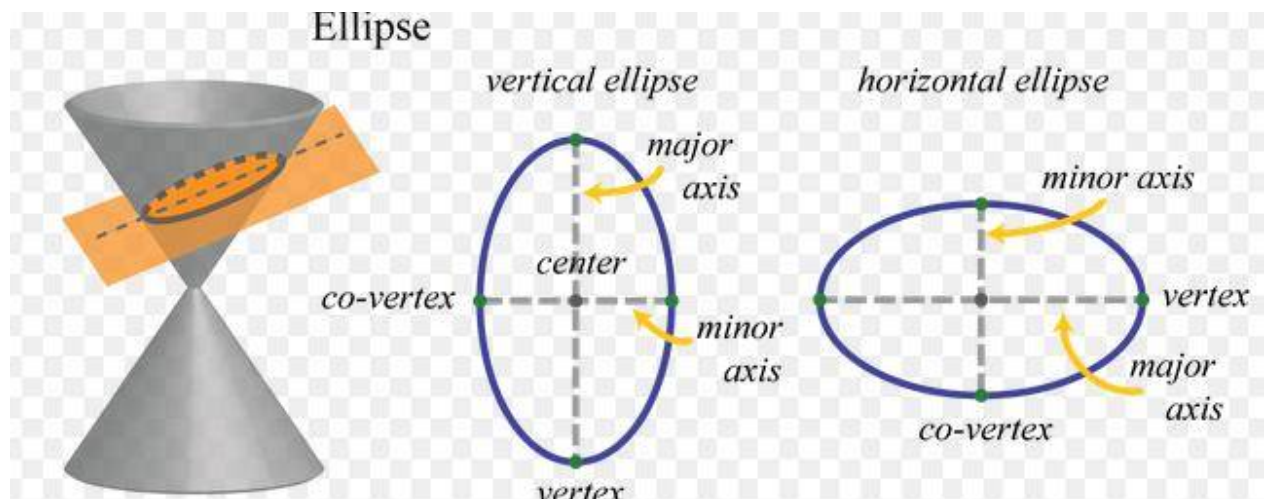

While the equations of the Ellipse is given as shown below

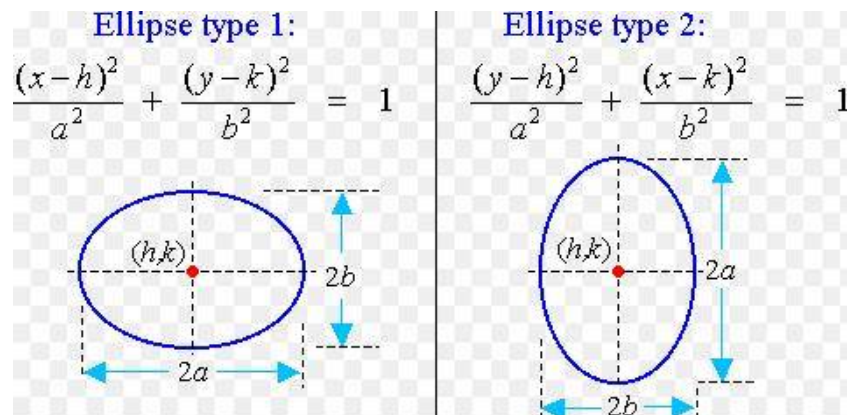

In these (h, k) is the center of the Ellipse. For the ellipse $a > b$

While if $b > a$ then the calculations are shown below

$$a^2 = b^2(1 - e^2)$$

$$\Rightarrow e^2 = 1 - a^2/b^2$$

$$\Rightarrow e = \sqrt{1 - \frac{a^2}{b^2}}$$

The shape of the ellipse is given below.

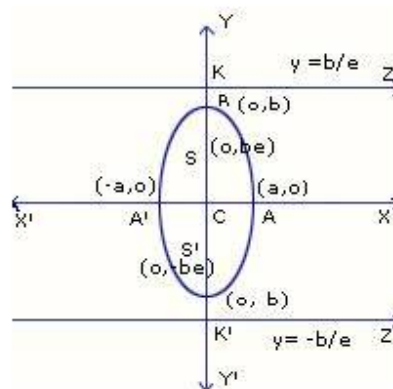

Now, this tells you where the foci are--they both lie on the major axis, at a distance of c from the center of the ellipse. But if you are trying to calculate the radius of curvature at the point y end (where the major axis intersects the ellipse), you can work directly from the formula for the ellipse:

$$\frac{x^2}{a^2} + \frac{y^2}{b^2} = 1$$

this assumes that the coordinate system has the origin at the ellipse's center.

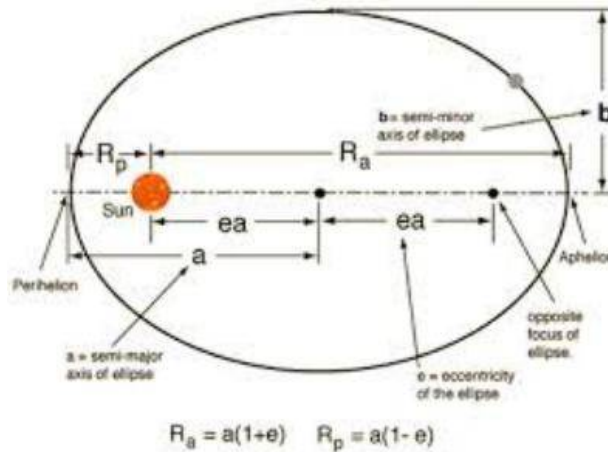

We need the radius of curvature at $(x,y) = (a,0)$.

This is actually a question that is found using calculus:

$$\text{radius of curvature } R = \frac{[(x')^2 + (y')^2]^{3/2}}{x'y'' - y'x''}$$

Or it can be written as shown below

$$R = \frac{\left(1 + \left(\frac{dy}{dx}\right)^2\right)^{3/2}}{\frac{d^2y}{dx^2}}$$

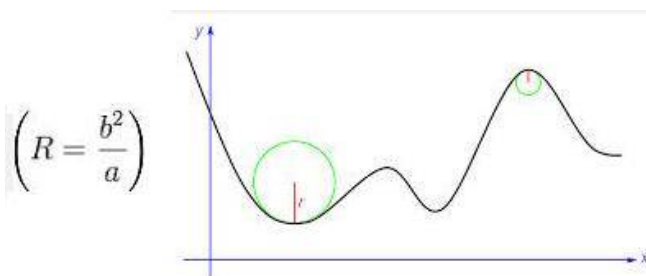

where the x and y coordinates can be parameterized as

$$\begin{aligned} x(t) &= a \cos(t), & y(t) &= b \sin(t) \\ x'(t) &= -a \sin(t), & y'(t) &= b \cos(t) \\ x''(t) &= -a \cos(t), & y''(t) &= -b \sin(t) \end{aligned}$$

Newton 's Law of Cooling by Prof. Subhashish Chattopadhyay SKMClasses Bangalore Useful for IIT-JEE, CBSE, I.Sc. PU-II, Boards, CET, CEE, PET, IGCSE IB AP-Physics and other exams

and plugging these into the expression for R gives us

$$R = \frac{[a^2 \sin^2(t) + b^2 \cos^2(t)]^{3/2}}{ab [\sin^2(t) + \cos^2(t)]}$$

The point $(x,y) = (a,0)$ occurs when $t=0$, so we plug $t=0$ into this expression to find the maximum possible radius of your cutting tool:

$$R(a,0) = \frac{[0 + (b^2) \cdot 1]^{3/2}}{a \cdot b \cdot 1} = \frac{b^3}{a \cdot b} = b^2 / a$$

You can see that if b/a is small (i.e., the ellipse is very squashed), then the radius of curvature is b^2/a , so that it is smaller than the semiminor axis b . And if $b=a$, then the ellipse is actually a circle, and it has radius of curvature equal to a , as required.

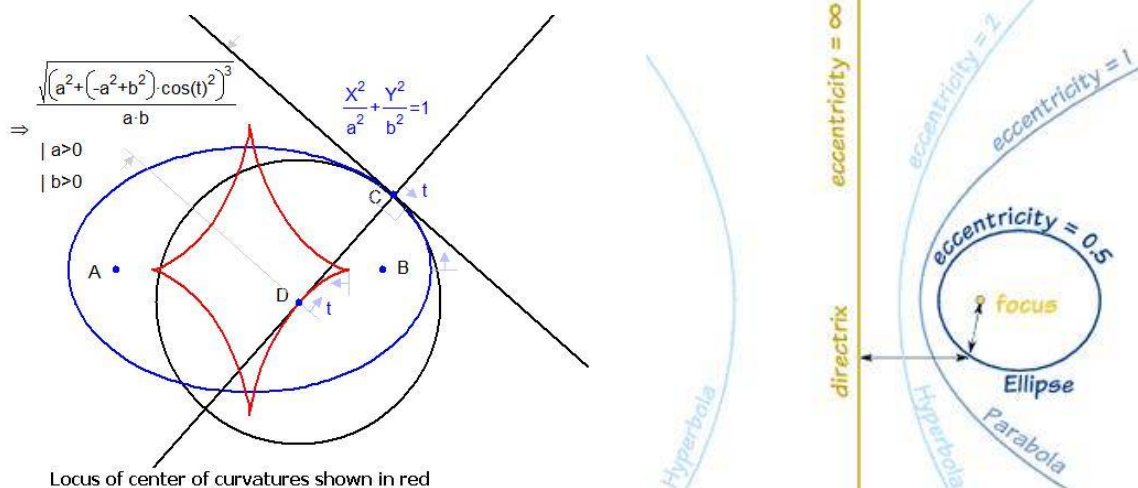

Motion in Variable Acceleration

Example - A body is Decelerating at Proportional to square of the distance ...

<https://archive.org/details/ABodyIsDeceleratingProportionalToXSquareWhatWillBeVelocoty>

Newton 's Law of Cooling by Prof. Subhashish Chattopadhyay SKMClasses Bangalore Useful for IIT-JEE, CBSE, I.Sc. PU-II, Boards, CET, CEE, PET, IGCSE IB AP-Physics and other exams

An important Concept in Buoyant Force

For Buoyant Force to act There must be liquid below

I have observed that most Text books only stop by saying that **Buoyant Force is the weight of the displaced liquid** (by the object). This works fine for discussion with Boats, floating blocks etc. But in some cases, there are issues with this statement. To give more clarity to students I would like to discuss the following...

Take 3 Jars whose inside bottom part is very smooth. Also take a Hemisphere, a Cylinder and a Cone. The **bottom** of the hemisphere, cone and cylinder **is very smooth**.



Now put the Cone, Cylinder, and the Hemisphere inside the Jar



The **density of the material of the Cone, Cylinder, and the Hemisphere is less than water.** If we pour water slowly, and fill-up partially or Fully **will** these objects float up ?

[**Because we took smooth surfaces, no water enters the bottom of the objects and jar**]



Do we have displaced liquid ? (yes).

Do we have weight of the displaced liquid ? (yes)

Is Buoyant Force acting ? (no).

The liquid pressure $h\rho g$ will act side wise (for cylinder) and down-wise for Cone and hemisphere. Recall the pressure is scalar, so can act in all / any possible directions as required at a particular place / spot. The liquid pressure tends to compress the objects, but due to absence of any liquid layer below the objects, the objects will **NOT float up**, even though the material density was lesser than water.

We could have taken hallow (but with no holes) steel or lead objects. The density of the material is many times higher than water, but the overall density (Total mass by Total volume) is lesser than that of water. In this case also if the bottom is smooth and no water layer enters below the object, the object will **NOT float up**.

So the complete statement of Buoyant force is ... "weight of the displaced liquid, if there is liquid below the object".

Consider the jar where a sphere is connected to the bottom.



This sphere will be subjected to Buoyant Force if some liquid is poured into the jar. **The material connecting the sphere will be subjected to (resultant) tensile force or compressive force; depending how much liquid is poured, and various values of size, volume, density etc.**



<- This is the limiting position (where the liquid surface is just touching the bottom of the sphere) where the bottom material is subjected to (only) compressive force due to weight of the sphere. No Buoyant Force yet.

More liquid poured, the sphere may be partially immersed or fully, (neglecting compression volume reduction of the sphere), the tensile force on the bottom material will keep increasing. So resultant force on the bottom material will be weight of sphere downward + the tensile force due to Buoyant force upwards. The resultant force will be up or down depending on the geometrical values, of size, density etc.

Liquid level just touching the top of the sphere, or little above the sphere will not make any difference on the resultant force.

Newton 's Law of Cooling by Prof. Subhashish Chattopadhyay SKMClasses Bangalore Useful for IIT-JEE, CBSE, I.Sc. PU-II, Boards, CET, CEE, PET, IGCSE IB AP-Physics and other exams

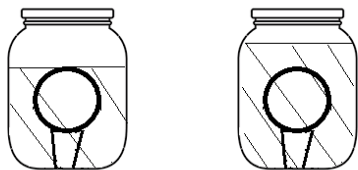

< - Both these Cases will have same Buoyant Force, same weight of the sphere, and thus same resultant force on the bottom material.

But in the following jar

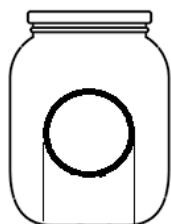

if some liquid is poured, no Buoyant Force will act. (Regardless the upper part or upper hemisphere is partly or fully submerged). The material is tangential at the horizontal diameter of the sphere. The material will be compressed downwards, if the liquid is above the diameter.

<https://archive.org/details/2ForBuoyantForceToActThereMustBeLiquidBelowIITJEEPhy>

Videos solving IIT-JEE problems (1962 1963 1966 1970 1971 1975 1984 etc)

<https://archive.org/details/6IITJEE1962BuoyantForceAtDiffTemps1973ApparentWeightBothBo bLiquidPhy>

-

About Empirical Formulae

In chemistry, the empirical formula of a chemical compound is the simplest positive integer ratio of atoms present in a compound. A simple example of this concept is that the empirical formula of hydrogen peroxide, or H_2O_2 , would simply be HO. Glucose ($C_6H_{12}O_6$), ribose ($C_5H_{10}O_5$), acetic acid ($C_2H_4O_2$), and formaldehyde (CH_2O) all have different molecular formulas but the same empirical formula: CH_2O . This is the actual molecular formula for formaldehyde, but acetic acid has double the number of atoms, ribose has five times the number of atoms, and glucose has six times the number of atoms.

In this article we are not discussing the above " Empirical formulas ". There is another kind of " Empirical formulas " where the constants are determined by experiments, rather than derived. The dimensions on the left side or in the right sides may or may not match, case to case basis.

Newton 's Law of Cooling by Prof. Subhashish Chattopadhyay SKMClasses Bangalore Useful for IIT-JEE, CBSE, I.Sc. PU-II, Boards, CET, CEE, PET, IGCSE IB AP-Physics and other exams

Slater's rule

In quantum chemistry, Slater's rules provide numerical values for the effective nuclear charge concept. In a many-electron atom, each electron is said to experience less than the actual nuclear charge owing to shielding or screening by the other electrons. For each electron in an atom, Slater's rules provide a value for the screening constant, denoted by s , S , or σ , which relates the effective and actual nuclear charges as

$$Z_{\text{effective}} = Z - \sigma \quad (\text{sigma})$$

The rules were devised semi-empirically by John C. Slater and published in 1930.

Revised values of screening constants based on computations of atomic structure by the Hartree-Fock method were obtained by Enrico Clementi et al in the 1960s

Steps to follow -

- 1.1) Write the electron configuration for the atom using the following design; (1s)(2s,2p)(3s,3p) (3d) (4s,4p) (4d) (4f) (5s,5p)
- 1.2) Any electrons to the right of the electron of interest contributes no shielding. (Approximately correct statement.)
- 1.3) All other electrons in the same group as the electron of interest shield to an extent of 0.35 nuclear charge units
- 1.4) If the electron of interest is an s or p electron: All electrons with one less value of the principal quantum number shield to an extent of 0.85 units of nuclear charge. All electrons with two less values of the principal quantum number shield to an extent of 1.00 units.
- 1.5) If the electron of interest is an d or f electron: All electrons to the left shield to an extent of 1.00 units of nuclear charge.
- 1.6) Sum the shielding amounts from steps 2 through 5 and subtract from the nuclear charge value to obtain the effective nuclear charge.

Examples:

Calculate Z^* for a valence electron in fluorine.

(1s²)(2s²,2p⁵)

Rule 2 does not apply; $0.35 \cdot 6 + 0.85 \cdot 2 = 3.8$

$Z^* = 9 - 3.8 = 5.2$ for a valence electron.

Calculate Z^* for a 6s electron in Platinum.

(1s²)(2s²,2p⁶)(3s²,3p⁶) (3d¹⁰) (4s²,4p⁶) (4d¹⁰) (4f¹⁴) (5s²,5p⁶) (5d⁸) (6s²)
 Rule 2 does not apply; $0.35 \cdot 1 + 0.85 \cdot 16 + 60 \cdot 1.00 = 73.95$

$Z^* = 78 - 73.95 = 4.15$ for a valence electron.

Shielding

The first ionization energy for hydrogen is 1310 kJ·mol⁻¹ while the first ionization energy for lithium is 520 kJ·mol⁻¹. The IE for lithium is lower for two reasons-

1.7) The average distance from the nucleus for a 2s electron is greater than a 1s electron;

1.8) The 2s¹ electron in lithium is repelled by the inner core electrons, so the valence electron is easily removed.

The inner core electrons shield the valence electron from the nucleus so the outer most electron only experiences an effective nuclear charge. In the case of the lithium the bulk of the 1s electron density lies between the nucleus and the 2s¹ electron. So the valence electron 'sees' the sum of the charges or approximately +1. In reality the charge the valence electron experiences is greater than 1 because the radial distribution show there is some probability of finding the 2s electron close to the nucleus.

Effective nuclear charge Z^* increases very slowly down a group for the "valence" i.e. outermost orbital e.g.

H	1.0	} Valence configuration same
Li	1.3	
Na	2.2	
K	2.2	
Rb	2.2	
Cs	2.2	

.....but increases rapidly along a period

Li	Be	B	C	N	O	F	Ne
1.3	1.95	2.6	3.3	3.9	4.6	5.2	5.9
2s ¹	2s ²	2p ¹	2p ²	2p ³	2p ⁴	2p ⁵	2p ⁶

Effective nuclear charges, Z_{eff}								
	H							He
Z	1							2
1s	1.00							1.69
	Li	Be	B	C	N	O	F	Ne
Z	3	4	5	6	7	8	9	10
1s	2.69	3.68	4.68	5.67	6.66	7.66	8.65	9.64
2s	1.28	1.91	2.58	3.22	3.85	4.49	5.13	5.76
2p			2.42	3.14	3.83	4.45	5.10	5.76
	Na	Mg	Al	Si	P	S	Cl	Ar
Z	11	12	13	14	15	16	17	18
1s	10.63	11.61	12.59	13.57	14.56	15.54	16.52	17.51
2s	6.57	7.39	8.21	9.02	9.82	10.63	11.43	12.23
2p	6.80	7.83	8.96	9.94	10.96	11.98	12.99	14.01
3s	2.51	3.31	4.12	4.90	5.64	6.37	7.07	7.76
3p			4.07	4.29	4.89	5.48	6.12	6.76

Moseley's Law

This law relates to the frequency of the spectral lines of the characteristic X-radiation of a chemical element to its atomic number. This law was experimentally established by H. Moseley in 1913. According to Moseley's law, the square root of the frequency ν of a spectral line of the characteristic radiation of an element is a linear function of its atomic number Z :

Newton 's Law of Cooling by Prof. Subhashish Chattopadhyay SKMClasses Bangalore Useful for IIT-JEE, CBSE, I.Sc. PU-II, Boards, CET, CEE, PET, IGCSE IB AP-Physics and other exams

$$\sqrt{\frac{\nu}{R}} = \frac{Z - S_n}{n}$$

where R is the Rydberg constant, S_n is the screening constant, and n is the principal quantum number. On a Moseley plot (see Figure 1), the dependence of $\sqrt{\nu}$ on Z is a series of lines (such as the K_α lines, L_α lines, and M_α lines, which correspond to the values $n = 1, 2,$ and 3).

Moseley's law was incontrovertible proof of the correctness of the arrangement of the elements in D. I. Mendeleev's periodic system of the elements and the law helped to clarify the physical significance of Z .

According to Moseley's law, the characteristic X-ray spectra do not display the periodic regularities that are inherent in optical spectra. This indicates that the inner electron shells of the atoms of all elements, which are manifested in the characteristic X-ray spectra, have an analogous structure.

Subsequent experiments revealed some deviations from a linear

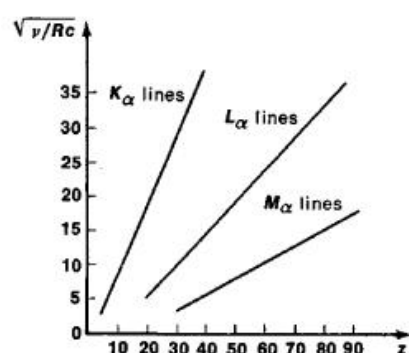

Einstein-Debey equation (Dulong & Petit)

Dulong and Petit gave an Empirical Law for molar specific heat of Solids. The Dulong-Petit law, a thermodynamic rule proposed in 1819 by French physicists Pierre Louis Dulong and Alexis Thérèse Petit, states the classical expression for the molar specific heat capacity of a crystal. Experimentally the two scientists had found that the heat capacity per weight (the mass-specific heat capacity) for a number of substances became close to a constant value, after it had been multiplied by number-ratio representing the presumed relative atomic weight of the substance. These atomic weights had shortly before been suggested by Dalton.

In modern terms, Dulong and Petit found that the heat capacity of a mole of many solid substances is about $3R$, where R is the modern constant called the universal gas constant. Dulong and Petit were unaware of the relationship with R , since this constant had not yet been defined from the later kinetic theory of gases. The value of $3R$ is about 25 joules per kelvin (Close to 6 Calories per Kelvin), and Dulong and Petit essentially found that this was the heat capacity of crystals, per mole of atoms they contained.

The modern theory of the heat capacity of solids states that it is due to lattice vibrations in the solid, and was first derived in crude form from this assumption by Albert Einstein, in 1907. The Einstein solid model thus gave for the first time a reason why the Dulong-Petit law should be stated in terms of the classical heat capacities for gases.

Newton 's Law of Cooling by Prof. Subhashish Chattopadhyay SKMClasses Bangalore Useful for IIT-JEE, CBSE, I.Sc. PU-II, Boards, CET, CEE, PET, IGCSE IB AP-Physics and other exams

Newton 's Law of Cooling by Prof. Subhashish Chattopadhyay SKMClasses Bangalore Useful for IIT-JEE, CBSE, I.Sc. PU-II, Boards, CET, CEE, PET, IGCSE IB AP-Physics and other exams

Einstein's oscillator treatment of specific heat gave qualitative agreement with experiment and gave the correct high temperature limit (the Law of Dulong and Petit). The quantitative fit to experiment was improved by Debye's recognition that there was a maximum number of modes of vibration in a solid. He pictured the vibrations as standing wave modes in the crystal, similar to the electromagnetic modes in a cavity which successfully explained blackbody radiation. The density of states for these modes, which are called "phonons", is of the same form as the photon density of states in a cavity.

In thermodynamics and solid state physics, the Debye model is a method developed by Peter Debye in 1912 for estimating the phonon contribution to the specific heat (heat capacity) in a solid. It treats the vibrations of the atomic lattice (heat) as phonons in a box, in contrast to the Einstein model, which treats the solid as many individual, non-interacting quantum harmonic oscillators. The Debye model correctly predicts the low temperature dependence of the heat capacity, which is proportional to T^3 (T Cube)

-

Reynolds number

In fluid mechanics, the Reynolds number (Re) is a dimensionless quantity that is used to help predict similar flow patterns in different fluid flow situations. The concept was introduced by George Gabriel Stokes in 1851, but the Reynolds number is named after Osborne Reynolds (1842-1912), who popularized its use in 1883

The Reynolds number is defined as the ratio of inertial forces to viscous forces and consequently quantifies the relative importance of these two types of forces for given flow conditions.

Reynolds numbers frequently arise when performing scaling of fluid dynamics problems, and as such can be used to determine dynamic similitude between two different cases of fluid flow. They are also used to characterize different flow regimes within a similar fluid, such as laminar or turbulent flow:

laminar flow occurs at low Reynolds numbers, where viscous forces are dominant, and is characterized by smooth, constant fluid motion;

turbulent flow occurs at high Reynolds numbers and is dominated by inertial forces, which tend to produce chaotic eddies, vortices and other flow instabilities.

In practice, matching the Reynolds number is not on its own sufficient to guarantee similitude. Fluid flow is generally chaotic, and very small changes to shape and surface roughness can result in very different flows. Nevertheless, Reynolds numbers are a very important guide and are widely used.

$R = \text{Inertial Forces} / \text{Viscous Forces} = \rho v L / \mu$

Inertial Force = $\rho (V^2) (L^2)$

Viscous Force = $\mu V L$

Newton 's Law of Cooling by Prof. Subhashish Chattopadhyay SKMClasses Bangalore Useful for IIT-JEE, CBSE, I.Sc. PU-II, Boards, CET, CEE, PET, IGCSE IB AP-Physics and other exams

Newton 's Law of Cooling by Prof. Subhashish Chattopadhyay SKMClasses Bangalore Useful for IIT-JEE, CBSE, I.Sc. PU-II, Boards, CET, CEE, PET, IGCSE IB AP-Physics and other exams

where

ρ = is the density of the fluid (kg/m^3).

ν = is the kinematic viscosity μ/ρ (m^2/s)

L = is a characteristic linear dimension, (travelled length of the fluid; hydraulic diameter when dealing with river systems) (m)

μ = is the dynamic viscosity of the fluid ($\text{Pa}\cdot\text{s}$ or $\text{N}\cdot\text{s}/\text{m}^2$ or $\text{kg}/(\text{m}\cdot\text{s})$)

-

Variation of viscosity with temperature

With an increase in temperature, there is typically an increase in the molecular interchange as molecules move faster in higher temperatures.

The gas viscosity will increase with temperature. According to the kinetic theory of gases, viscosity should be proportional to the square root of the absolute temperature, in practice, it increases more rapidly.

In a liquid there will be molecular interchange similar to those developed in a gas, but there are additional substantial attractive, cohesive forces between the molecules of a liquid (which are much closer together than those of a gas). Both cohesion and molecular interchange contribute to liquid viscosity.

The impact of increasing the temperature of a liquid is to reduce the cohesive forces while simultaneously increasing the rate of molecular interchange.

The former effect causes a decrease in the shear stress while the latter causes it to increase. The result is that liquids show a reduction in viscosity with increasing temperature. With high temperatures, viscosity increases in gases and decreases in liquids, the drag force will do the same.

The impact of increasing temperature will be to slow down the sphere in gases and to accelerate it in liquids. When you consider a liquid at room temperature, the molecules are tightly bound together by attractive inter-molecular forces (e.g. Van der Waal forces).

It is these attractive forces that are responsible for the viscosity since it is difficult for individual molecules to move because they are tightly bound to their neighbors.

The increase in temperature causes the kinetic or thermal energy to increase and the molecules become more mobile.

The attractive binding energy is reduced and therefore the viscosity is reduced. If you continue to heat the liquid the kinetic energy will exceed the binding energy and molecules will escape from the liquid and it can become a vapor.

So the temperature dependence of liquid viscosity is the phenomenon by which liquid viscosity tends to decrease (or, alternatively, its fluidity tends to increase) as its temperature

Newton 's Law of Cooling by Prof. Subhashish Chattopadhyay SKMClasses Bangalore Useful for IIT-JEE, CBSE, I.Sc. PU-II, Boards, CET, CEE, PET, IGCSE IB AP-Physics and other exams

Newton 's Law of Cooling by Prof. Subhashish Chattopadhyay SKMClasses Bangalore Useful for IIT-JEE, CBSE, I.Sc. PU-II, Boards, CET, CEE, PET, IGCSE IB AP-Physics and other exams

increases. This can be observed, for example, by watching how cooking oil appears to move more fluidly upon a frying pan after being heated by a stove.

Exponential model

An exponential model for the temperature-dependence of shear viscosity (μ) was first proposed by Reynolds in 1886.

$$\mu(T) = \mu_0 \exp(-bT)$$

where T is temperature and μ_0 and b are coefficients. See first-order fluid and second-order fluid. This is an empirical model that usually works for a limited range of temperatures.

Arrhenius model

The model is based on the assumption that the fluid flow obeys the Arrhenius equation for molecular kinetics:

$$\mu(T) = \mu_0 \exp\left(\frac{E}{RT}\right)$$

where T is temperature, μ_0 is a coefficient, E is the activation energy and R is the universal gas constant. A first-order fluid is another name for a power-law fluid with exponential dependence of viscosity on temperature.

Williams-Landel-Ferry model

The **Williams-Landel-Ferry** model, or **WLF** for short, is usually used for polymer melts or other fluids that have a glass transition temperature.

The model is:

$$\mu(T) = \mu_0 \exp\left(\frac{-C_1(T - T_r)}{C_2 + T - T_r}\right)$$

where T -temperature, C_1 , C_2 , T_r and μ_0 are empiric parameters (only three of them are independent from each other).

If one selects the parameter T_r based on the glass transition temperature, then the parameters C_1 , C_2 become very similar for the wide class of polymers. Typically, if T_r is set to match the glass transition temperature T_g , we get

$$C_1 \approx 17.44$$

and

$$C_2 \approx 51.6 \text{ K}$$

Van Krevelen recommends to choose

$$T_r = T_g + 43 \text{ K, then}$$

$$C_1 \approx 8.86$$

and

$$C_2 \approx 101.6 \text{ K}$$

Using such *universal parameters* allows one to guess the temperature dependence of a polymer by knowing the viscosity at a single temperature.

In reality the *universal parameters* are not that universal, and it is much better to fit the **WLF** parameters from the experimental data.

Masuko and Magill model

The model is usually used for **polymer melts** or other fluids that have a **glass transition temperature** as well as the **WLF model**. Ordinarily, The WLF model is limited to the temperature interval between T_g and $T_g + 100 \text{ K}$. But this model can be applied to more wide temperature range.

The model is:

$$\log(\eta/\eta_g) = A \left[\exp\left\{\frac{B(T_g - T)}{T}\right\} - 1 \right]$$

The **A** and **B** are empirical parameters that does not depend on the materials. The average values are:

$$A = 14.25 \text{ to } 16.24,$$

and

$$B = 5.34 \text{ to } 7.60.$$

Newton 's Law of Cooling by Prof. Subhashish Chattopadhyay SKMClasses Bangalore Useful for IIT-JEE, CBSE, I.Sc. PU-II, Boards, CET, CEE, PET, IGCSE IB AP-Physics and other exams

Newton 's Law of Cooling by Prof. Subhashish Chattopadhyay SKMClasses Bangalore Useful for IIT-JEE, CBSE, I.Sc. PU-II, Boards, CET, CEE, PET, IGCSE IB AP-Physics and other exams

Viscosity of water

Viscosity of water equation accurate to within 2.5% from 0 °C to 370 °C:

$$\mu(T) = 2.414 \times 10^{-5} \times 10^{247.8/(T-140)}$$

where T has units of Kelvin, and μ has units of N·s/m².

Models for kinematic viscosity

The effect of temperature on the kinematic viscosity (ν) has also been described by a number of empirical equations.

Walther formula

The Walther formula is typically written in the form

$$\log_{10}[\log_{10}(\nu + \lambda)] = A - B \log_{10}(T)$$

where λ is a shift constant, and A, B are empirical parameters.

Wright model

The Wright model has the form

$$\log_{10}[\log_{10}[\nu + \lambda + f(\nu)]] = A - B \log_{10}(T)$$

where an addition function $f(\nu)$, often a polynomial fit to experimental data, has been added to the Walther formula.

Seeton model

The Seeton model is based on curve fitting the viscosity dependence of many liquids (refrigerants, hydrocarbons and lubricants) versus temperature and applies over a large temperature and viscosity range:

$$\ln \left(\ln \left(\nu + 0.7 + e^{-\nu} K_0 (\nu + 1.244067) \right) \right) = A - B * \ln(T)$$

where T is absolute temperature in kelvins, ν is the kinematic viscosity in centistokes, K_0 is the zero order modified Bessel function of the second kind, and A and B are liquid specific values. This form should not be applied to ammonia or water viscosity over a large temperature range.

For liquid metal viscosity as a function of temperature, Seeton proposed:

$$\ln \left(\ln \left(\nu + 0.7 + e^{-\nu} K_0 (\nu + 1.244067) \right) \right) = A - \frac{B}{T}$$

Variation of surface tension with temperature

Surface tension is dependent on temperature. For that reason, when a value is given for the surface tension of an interface, temperature must be explicitly stated. The general trend is that surface tension decreases with the increase of temperature, reaching a value of 0 at the critical temperature. For further details see the Eötvös rule below. There are only empirical equations to relate surface tension and temperature:

Newton 's Law of Cooling by Prof. Subhashish Chattopadhyay SKMClasses Bangalore Useful for IIT-JEE, CBSE, I.Sc. PU-II, Boards, CET, CEE, PET, IGCSE IB AP-Physics and other exams

Newton 's Law of Cooling by Prof. Subhashish Chattopadhyay SKMClasses Bangalore Useful for IIT-JEE, CBSE, I.Sc. PU-II, Boards, CET, CEE, PET, IGCSE IB AP-Physics and other exams

Eötvös:

$$\gamma V^{2/3} = k(T_C - T)$$

Here V is the molar volume of that substance, T_C is the critical temperature and k is a constant valid for almost all substances. A typical value is $k = 2.1 \times 10^{-7} \text{ [J K}^{-1} \text{ mol}^{-2/3}]$. For water one can further use $V = 18 \text{ ml/mol}$ and $T_C = 374^\circ\text{C}$.

A variant on Eötvös is described by Ramay and Shields:

$$\gamma V^{2/3} = k(T_C - T - 6)$$

where the temperature offset of 6 kelvins provides the formula with a better fit to reality at lower temperatures.

- o Guggenheim-Katayama:

$$\gamma = \gamma^o \left(1 - \frac{T}{T_C}\right)^n$$

γ^o is a constant for each liquid and n is an empirical factor, whose value is 11/9 for organic liquids. This equation was also proposed by van der Waals, who further proposed that γ^o could be given by the expression, $K_2 T_C^{-1/3} P_C^{2/3}$, where K_2 is a universal constant for all liquids, and P_C is the critical pressure of the liquid (although later experiments found K_2 to vary to some degree from one liquid to another).

Both Guggenheim-Katayama and Eötvös take into account the fact that surface tension reaches 0 at the critical temperature, whereas Ramay and Shields fails to match reality at this endpoint.

Liquid drop model of Nucleus



In nuclear physics, description of atomic nuclei formulated (1936) by Niels Bohr and used (1939) by him and John A. Wheeler to explain nuclear fission. According to the model, the nucleons (neutrons and protons) behave like the molecules in a drop of liquid. If given sufficient extra energy (as by the absorption of a neutron), the spherical nucleus may be distorted into a dumbbell shape and then split at the neck into two nearly equal fragments, releasing energy. Although inadequate to explain all nuclear phenomena, the theory underlying the model provides excellent estimates of average properties of nuclei.

The semi-empirical mass formula (SEMF) (sometimes also called Weizsäcker's formula, or the Bethe-Weizsäcker formula, or the Bethe-Weizsäcker mass formula to distinguish it from the Bethe-Weizsäcker process) is used to approximate the mass and various other properties of an atomic nucleus from its number of protons and neutrons. As the name suggests, it is based partly on theory and partly on empirical measurements. The theory is based on the liquid drop model proposed by George Gamow, which can account for most of the terms in the formula and gives rough estimates for the values of the coefficients. It was first formulated in 1935 by German physicist Carl Friedrich von Weizsäcker, and although refinements have been made to the coefficients over the years, the structure of the formula remains the same today.

The SEMF gives a good approximation for atomic masses and several other effects, but does not explain the appearance of magic numbers of protons and neutrons, and the extra binding-energy and measure of stability that are associated with these numbers of nucleons.

Newton 's Law of Cooling by Prof. Subhashish Chattopadhyay SKMClasses Bangalore Useful for IIT-JEE, CBSE, I.Sc. PU-II, Boards, CET, CEE, PET, IGCSE IB AP-Physics and other exams

Nuclear Shell Model



Maria Goeppert Mayer, who made important discoveries about nuclear structure, is one of only two women to have won the Nobel Prize in physics.

In August 1948, Goeppert Mayer published her first paper detailing the evidence for the nuclear shell model, which accounts for many properties of atomic nuclei.

During her time at Chicago and Argonne in the late 1940s, Goeppert Mayer developed a mathematical model for the structure of nuclear shells, which she published in 1950. Her model explained why certain numbers of nucleons in an atomic nucleus result in particularly stable configurations. These numbers are what Eugene Wigner called magic numbers: 2, 8, 20, 28, 50, 82, and 126. Enrico Fermi provided a critical insight by asking her: "Is there any indication of spin orbit coupling?" She realised that this was indeed the case, and postulated that the nucleus is a series of closed shells and pairs of neutrons and protons tend to couple together. She described the idea as follows:

Think of a room full of waltzers. Suppose they go round the room in circles, each circle enclosed within another. Then imagine that in each circle, you can fit twice as many dancers by having one pair go clockwise and another pair go counterclockwise. Then add one more variation; all the dancers are spinning twirling round and round like tops as they circle the room, each pair both twirling and circling. But only some of those that go counterclockwise are twirling counterclockwise. The others are twirling clockwise while circling counterclockwise. The same is true of those that are dancing around clockwise: some twirl clockwise, others twirl counterclockwise.

Three German scientists, Otto Haxel, J. Hans D. Jensen, and Hans Suess, were also working on solving the same problem, and arrived at the same conclusion independently. Their results were announced in the issue of the Physical Review before Goeppert Mayer 's announcement in June 1949. Afterwards, she collaborated with them. Hans Jensen co-authored a book with Goeppert Mayer in 1950 titled Elementary Theory of Nuclear Shell Structure. In 1963, Goeppert Mayer, Jensen, and Wigner shared the Nobel Prize for Physics "for their discoveries concerning nuclear shell structure." She was the second and most recent female Nobel laureate in physics, after Marie Curie.

See <http://www.physicsoftheuniverse.com/intro.html>

The **shell model** of the nucleus presumes that a given nucleon moves in an effective attractive potential formed by all the other nucleons. If that is true, then the potential is probably roughly proportional to the nuclear density and therefore could be expressed in the form

$$V = \frac{-V_0}{1 + \exp\left(\frac{r-R}{a}\right)}$$

The parameters in this model of the potential have been evaluated to be approximately evaluated:

$$V_0 \approx 57 \text{ MeV} + \text{corrections}$$

$$R \approx 1.25A^{1/3} \text{ fermi}$$

$$a \approx 0.65 \text{ fermi}$$

Note that the radius above is larger than that given by the nuclear radius formula since it is related to the nuclear force which extends beyond the radius. Two other corrections are typically applied to more nearly fit observations. The first is called the symmetry energy, arising when there is an unequal number of protons and neutrons. Empirically, it is evaluated as

$$\Delta V_s = \pm 27 \text{ MeV} \left[\frac{N-Z}{A} \right] \begin{array}{l} - \text{ neutrons} \\ + \text{ protons} \end{array}$$

The other correction for protons is the electrostatic repulsion energy, which takes the form

$$V(r) = \frac{Zke^2}{R_c} \left(1 + \frac{1}{2} \left[1 - \left(\frac{r}{R_c} \right)^2 \right] \right) \quad r < R_c$$

$$V(r) = \frac{Zke^2}{r} \quad r > R_c$$

R_c = charge radius, distinct from R , the model radius for the nuclear potential.

The approximate potentials for neutrons and protons take the general form shown at left below.

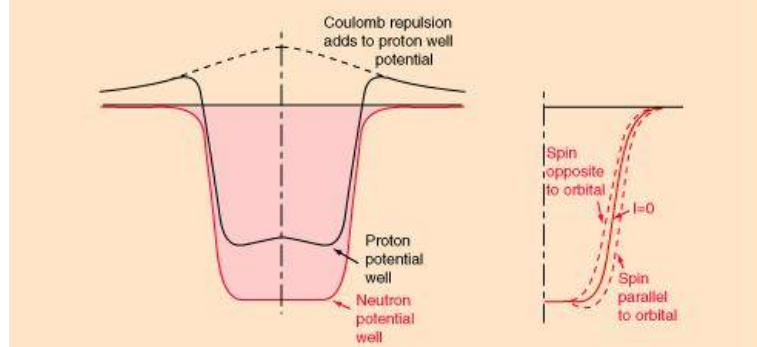

Newton 's Law of Cooling by Prof. Subhashish Chattopadhyay SKMClasses Bangalore Useful for IIT-JEE, CBSE, I.Sc. PU-II, Boards, CET, CEE, PET, IGCSE IB AP-Physics and other exams

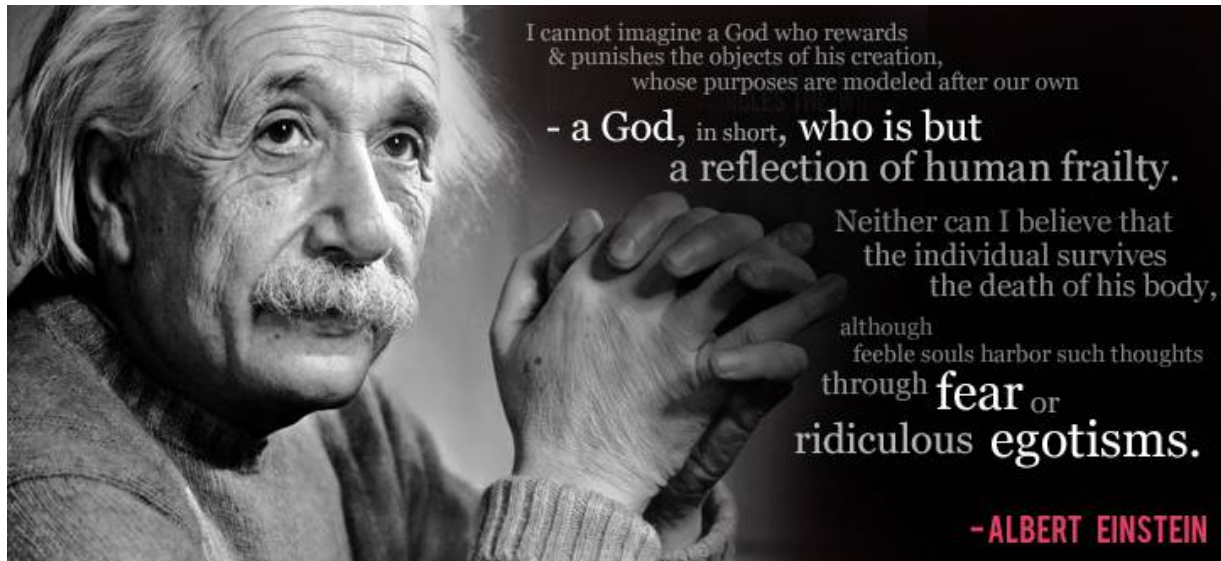

(Apart from Millions of smart people) Several Nobel Laureates were Atheists.

Some famous examples have been **Albert Einstein** (1921), **Richard Feynman** (1965), **Erwin Schrödinger** (1933), **Paul Dirac** (1933), **Lawrence M. Krauss** (2011), **Niels Bohr** (1922), **Peter Higgs** (2013), **John Bardeen** (**The only person receiving the Physics Nobel prize twice. 1956, 1972**), **Frederick Sanger** (**The only person receiving the Chemistry prize twice. 1958, 1980**), **Marie Curie** (1903, 1911), **Frédéric Joliot-Curie and Irène Joliot-Curie** (1935), **Milton Friedman** (1976), **John Harsanyi** (1994), **Friedrich Hayek** (1974), **John Forbes Nash, Jr.** (1994), **Amartya Sen** (1998), **Subrahmanyan Chandrasekhar** (1983), **Enrico Fermi** (1938), **C. V. Raman** (1930), **Eugene Wigner** (1963), **Steven Weinberg** (1979), **Chen-Ning Yang** (1957) etc

A bigger (incomplete) list can be seen at

https://en.wikipedia.org/wiki/List_of_nonreligious_Nobel_laureates

Important Scientists <http://www.physicsoftheuniverse.com/scientists.html>

<http://www.physicsoftheuniverse.com/facts.html>

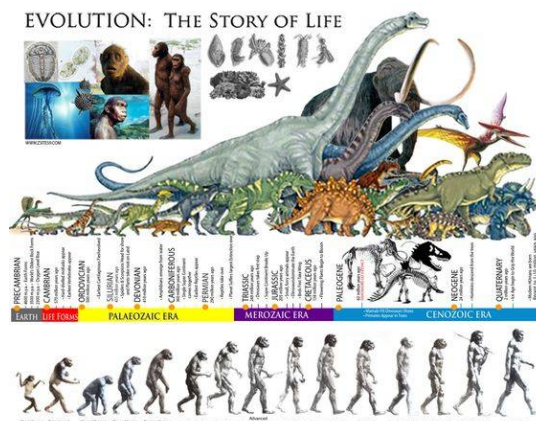

Newton 's Law of Cooling by Prof. Subhashish Chattopadhyay SKMClasses Bangalore Useful for IIT-JEE, CBSE, I.Sc. PU-II, Boards, CET, CEE, PET, IGCSE IB AP-Physics and other exams

Newton 's Law of Cooling by Prof. Subhashish Chattopadhyay SKMClasses Bangalore Useful for IIT-JEE, CBSE, I.Sc. PU-II, Boards, CET, CEE, PET, IGCSE IB AP-Physics and other exams

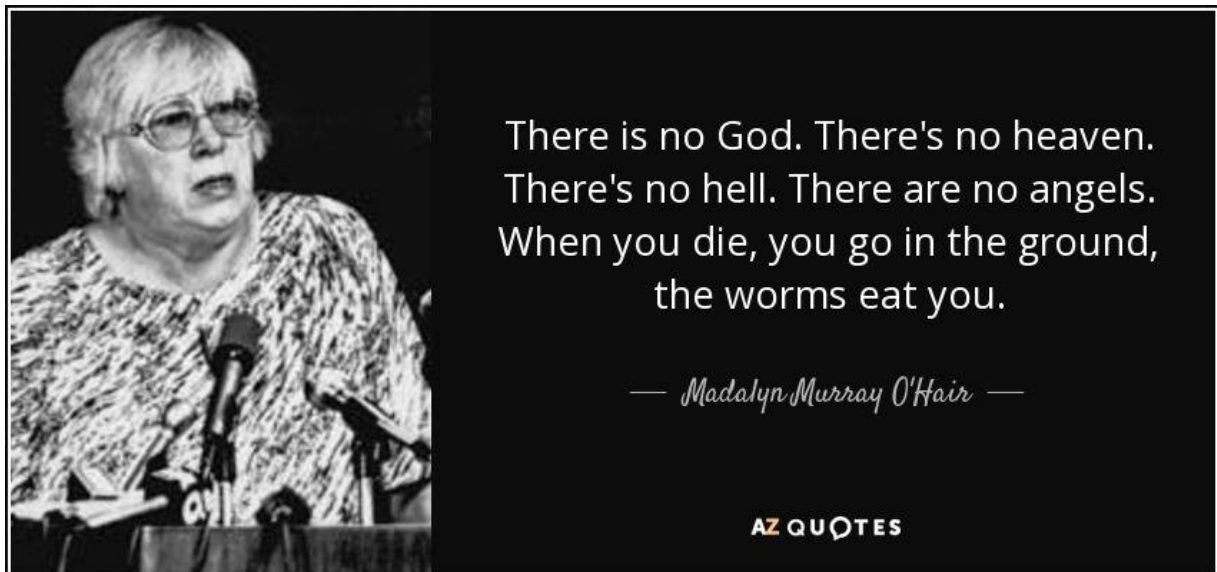

(When the body is burnt, oxides are the ash. The gases and water vapor spread in the air)

My **personal favorites** (among these Atheists) are **Richard Feynman**, **Peter Higgs**, **Lawrence Krauss**.

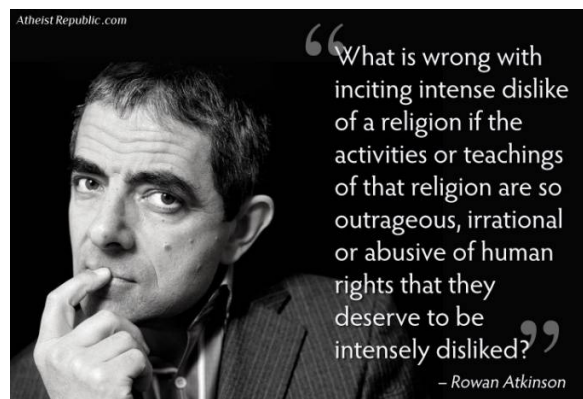
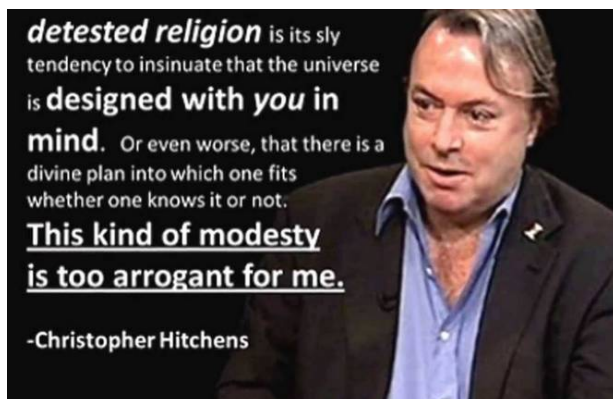

Richard Feynman openly laughed (Publicly and in class) about Gods, Fairies etc. see <https://www.youtube.com/watch?v=j3mhkYbnBk>

and https://www.youtube.com/results?search_query=Richard+Feynman

https://www.youtube.com/watch?v=JzWzLyGuPRY&list=PL_6G_2_0gFDqFjq4gZbmDvJT4bnvnNwr-

Approx 200 years ago; around 1800, Pierre-Simon Laplace developed a **new branch of Mathematics**, **Perturbation theory**. Perturbation theory was investigated by the classical scholars — Laplace, Poisson, Gauss — as a result of which the computations could be performed with a **very high accuracy**. The discovery of the planet Neptune in 1848 by Urbain Le Verrier, based on the deviations in motion of the planet Uranus (he sent the coordinates to

Newton 's Law of Cooling by Prof. Subhashish Chattopadhyay SKMClasses Bangalore Useful for IIT-JEE, CBSE, I.Sc. PU-II, Boards, CET, CEE, PET, IGCSE IB AP-Physics and other exams

Newton 's Law of Cooling by Prof. Subhashish Chattopadhyay SKMClasses Bangalore Useful for IIT-JEE, CBSE, I.Sc. PU-II, Boards, CET, CEE, PET, IGCSE IB AP-Physics and other exams

Johann Gottfried Galle who successfully observed Neptune through his telescope), represented a triumph of perturbation theory.

Laplace was **one the first persons** who did **not** see or use "hand of God" (or role of God) to explain something. Newton's Gravitation equations for Two masses, were not enough to explain stability of multibody, rather multi planet and Sun system. **Perturbation Theory could accommodate cumulative effects of many small forces.**

While talking to Napoleon,(discussing the theory); Laplace said, (about God) "**that**" (God) hypothesis is **not** needed.

<http://www.naturalhistorymag.com/universe/211420/the-perimeter-of-ignorance>

https://en.wikipedia.org/wiki/Perturbation_theory

https://en.wikipedia.org/wiki/Pierre-Simon_Laplace

Peter Higgs was very unhappy about " Higgs Boson " being called "G..(I don't want to name this) Particle". **Stupid Journalists**, Media, and dumb people kept repeating that word, and **Peter requested to refrain from using this word**. Now for Madala Boson also the **Stupid Journalists**, Media, and dumb people are using that same G word.

Lawrence Krauss openly laughs and ridicules the Theists or any non-Atheists. The crap of Agnosticism does not work with me or Krauss.

Empty Space is not empty. Mass of Proton, Neutron is not sum of masses of Quarks

<https://archive.org/details/EmptySpaceIsNotEmptyMassOfProtonNeutronIsNotSumOfMassesOfQuarks>

We are in Modern Times. I am lucky to learn the correct things quite early in my life, in a so " peaceful " society. When I was in standard 9, (in early 1980s), I was writing a book on Atheism. I was convinced to understand, learn, and imbibe the correct approach and knowledge.

But that was not the case previously. Copernicus used to discuss and explain people widely and randomly, that Earth is rotating around the Sun, and it is not a Geocentric" universe. Nicolaus Copernicus had to waste lot of time arguing, fighting and convincing the stupids.

Measuring something, which is very slow; is very difficult. I have asked lot of "educated / engineer / Software or IT (senior position) Parents" that " How do we know that Earth is moving around the Sun in 365 days or say 365.242196 days " ? **Believe me I never got an answer**. The Modern iPad / smartphone **community in general does not know how 365.24 days was measured almost thousand years ago !**

A metal triangle was set at top of buildings (Mosques or churches) and the position of the shadow was marked at a particular time. Say 8 AM each day. The position of the shadow varied each day. It was seen that after 365 days the shadow matched the position but after

Newton 's Law of Cooling by Prof. Subhashish Chattopadhyay SKMClasses Bangalore Useful for IIT-JEE, CBSE, I.Sc. PU-II, Boards, CET, CEE, PET, IGCSE IB AP-Physics and other exams

Newton 's Law of Cooling by Prof. Subhashish Chattopadhyay SKMClasses Bangalore Useful for IIT-JEE, CBSE, I.Sc. PU-II, Boards, CET, CEE, PET, IGCSE IB AP-Physics and other exams

sometime, not exactly at 8 AM but after a few hours (approx 6 hours) so at around 2 PM or slightly before.

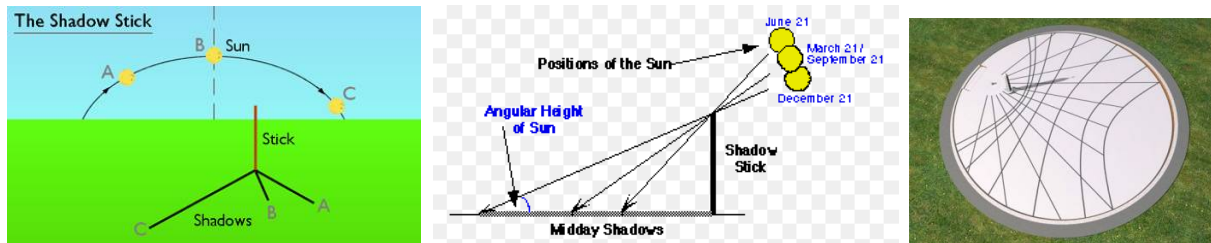

See details of this at <http://blog.world-mysteries.com/science/ancient-timekeepers-part-2-observing-the-sky/>

<http://blog.world-mysteries.com/science/ancient-timekeepers-part4-calendars/>

See the video https://www.youtube.com/watch?v=lhqzW97_47w

<https://thecuriousastronomer.wordpress.com/2012/10/>

Much tougher questions are " How many different kind of years do we have ? "

Or " What is the difference between ' **Sidereal year** ' and ' **Tropical year** ' "

Meteors were coming from sky. These were called ' shooting stars '. Meteors often had Iron in them. Sidereal is a combining form meaning "star," "constellation," used in the formation of compound words. Greeks used the word siderolite for Iron. Next the source of meteors; the sky itself was named the same. As year was measured using objects from sky; Sun and shadows; the year was named a " **Sidereal Year** "

To avoid embarrassing people; I don't ask

See the answers in <https://www.youtube.com/watch?v=cGjP3vAZGa4>

<https://www.youtube.com/watch?v=qgsrVyW53DY>

It took many centuries to introduce the leap year corrections. A century is a leap year only if divisible by 400 and not the rule of divisible by 4. Year 1900 was not a Leap year. But year 2000 was. I have met computer Science guys who are aware that Microsoft Database SQL-server do not accept some old dates, while Oracle database does not accept some specific dates of the past. But none whom I met knew the detailed or actual reasons.

See <https://zookeepersblog.wordpress.com/everyone-must-know-about-the-calendar/>

" How do you prove that day and night is happening due to rotation of Earth around it own axis in contrast to Sun is rotating around Earth " ?

See <http://www.visual-arts-cork.com/prehistoric-art-timeline.htm>

Newton 's Law of Cooling by Prof. Subhashish Chattopadhyay SKMClasses Bangalore Useful for IIT-JEE, CBSE, I.Sc. PU-II, Boards, CET, CEE, PET, IGCSE IB AP-Physics and other exams

Newton 's Law of Cooling by Prof. Subhashish Chattopadhyay SKMClasses Bangalore Useful for IIT-JEE, CBSE, I.Sc. PU-II, Boards, CET, CEE, PET, IGCSE IB AP-Physics and other exams

No student from Bangalore, whom I met, answered this. Though conservation of Angular Momentum is in course. (I am being polite) Hardly met any parent who knew the explanation. See https://www.youtube.com/watch?v=iqpV1236_Q0

And <https://www.youtube.com/results?q=Foucault%27s+pendulum>

What about Gyroscopes ?

Approx 300 year back around 1750 the gyroscopes were made.

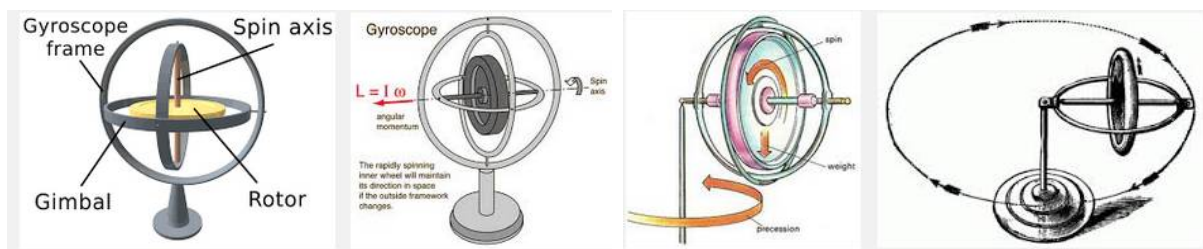

History of Gyroscope <http://www.gyroscopes.org/history.asp>

See about Gyroscopes in https://www.youtube.com/watch?v=cquvA_lpEsA

<https://www.youtube.com/watch?v=awXTZt86gz0>

<https://www.youtube.com/watch?v=zbdrrpXb-fY>

<https://www.youtube.com/watch?v=N92FYHHT1qM>

https://en.wikipedia.org/wiki/Earth%27s_orbit

<https://www.youtube.com/watch?v=ZcWsjIGPPFQ>

Must see

<https://www.youtube.com/watch?v=SnMmBmzoVOc&list=PL68IJE2PG4AnVVMs7WvOYbJDmqf4umHG1>

Must know ...

https://www.youtube.com/watch?v=zjV3PQ4f6IM&list=PLTve54sz-eh_P29Sbbv_j3bc97OFaArOd

Tyco Brahe took the boldest step to create the " Foundation of Science ". Experiments or "Double blind experimental observations" are the supreme. The **Theory follows the experimental verification.**

[There are some universities who award M.Sc in Psychology. A psychologist may **guess** something **But that is not reality or truth.** Till something is experimentally verified it remains as a Perception. Truth is known only after experiments. Because the subject Psychology; completely stands of experimental verification; so the Master in Science degree.]

Newton 's Law of Cooling by Prof. Subhashish Chattopadhyay SKMClasses Bangalore Useful for IIT-JEE, CBSE, I.Sc. PU-II, Boards, CET, CEE, PET, IGCSE IB AP-Physics and other exams

Newton 's Law of Cooling by Prof. Subhashish Chattopadhyay SKMClasses Bangalore Useful for IIT-JEE, CBSE, I.Sc. PU-II, Boards, CET, CEE, PET, IGCSE IB AP-Physics and other exams

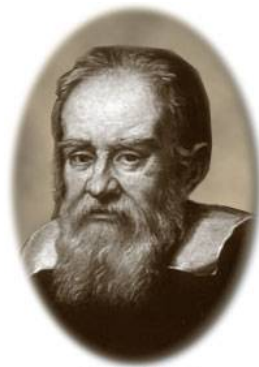

Galileo Galilei (1564-1642)

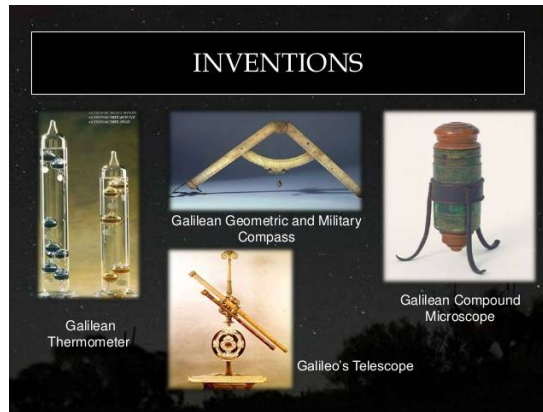

Galileo was the first person who wanted to experimentally verify the speed of light.

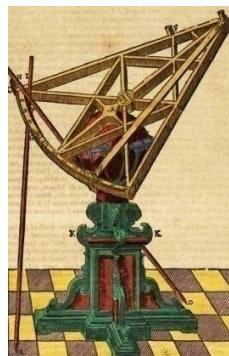
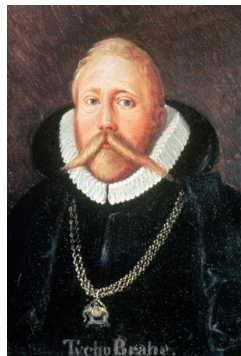

Tycho decided to observe the skies (around 1573). In those days sky was synonymous to God. He had the courage to go to the King to ask for donations to make an observatory. He said to the king that "he wants to observe the Gods and take conclusions ". Salute to Tycho's paradigm that even Gods can be observed and conclusions can be drawn.

Amazing leap to start Science.

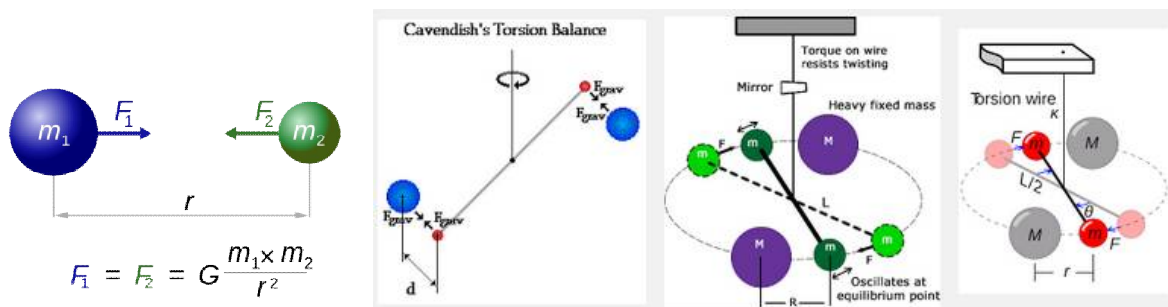

Since those days till now we observed and concluded about Kepler's Laws, Gravitation Laws, We concluded that there was no **Phlogiston** or Flogiston, Cavendish measuring value of G, measuring speed of light, X-Ray, **Electromagnetism / Maxwell's equations**, Radioactivity, No Aether was " observed " in Michelson Morley's experiments, Protons, Neutrons, General Theory of Relativity, Slowing of clocks at high speed, Bending of space, **Bending of light and**

Newton 's Law of Cooling by Prof. Subhashish Chattopadhyay SKMClasses Bangalore Useful for IIT-JEE, CBSE, I.Sc. PU-II, Boards, CET, CEE, PET, IGCSE IB AP-Physics and other exams

Newton 's Law of Cooling by Prof. Subhashish Chattopadhyay SKMClasses Bangalore Useful for IIT-JEE, CBSE, I.Sc. PU-II, Boards, CET, CEE, PET, IGCSE IB AP-Physics and other exams

gravitational lens, YDSE, Quantum Mechanics, Ernst **Ruska** designed and built the first **electron microscope**, **Casimir Forces**, Virtual particles and more than 400 kinds of particles, Quarks, Unruh effect (an accelerating thermometer shows higher temperature), Negative Kelvin Temperature, Bose-Einstein condensates, Superconductivity, **Solution to EPR paradox by John Stewart Bell**, Violation of Parity in certain situations - Madam Wu, Yang and Lee, Quantum entanglement in Alain Aspect's Experiments, Black holes, mass of Neutrinos, Caesium Atomic Clocks, Dark Matter, Dark energy, Magnetic Monopole, Gravitational Waves, Nano Materials, Meta Materials, Quantum Computers

No God was observed, or **no role of God was observed**. There is no conspiracy theory going around in Science. Those who want to verify God have to die waiting

... Nothing ever will be reported regarding this illusion.

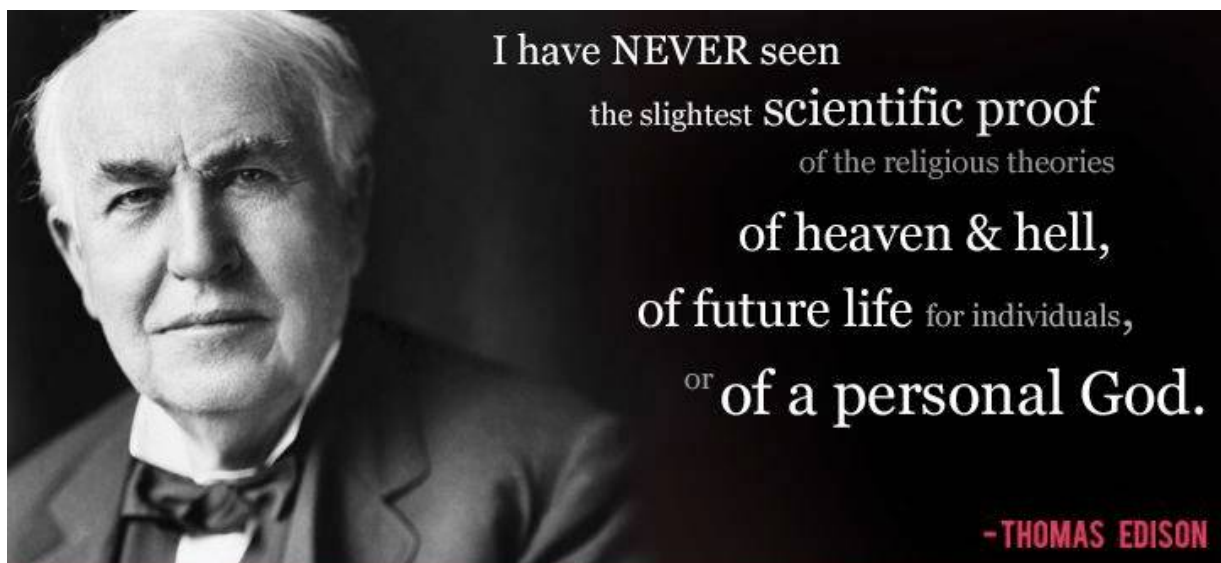

[**Stupids had proposed the phlogiston theory**. This was a superseded scientific theory that postulated that a fire-like element called phlogiston is contained within combustible bodies and released during combustion. The name comes from the Ancient Greek φλογιστόν phlogistón (burning up), from φλόξ phlóx (flame).]

In contrast see <http://www.americanscientist.org/issues/pub/burn-magnet-burn>

Some examples of stupidity to show / explain by contrasts; will be the right approach.

Newton 's Law of Cooling by Prof. Subhashish Chattopadhyay SKMClasses Bangalore Useful for IIT-JEE, CBSE, I.Sc. PU-II, Boards, CET, CEE, PET, IGCSE IB AP-Physics and other exams

Aristotle used goat urine and Hippocrates recommended pigeon droppings. For what?



As a treatment for baldness. Men have never found baldness an appealing trait, in spite of stories that bald men are sexier. (Stories usually spread by bald men.) Virtually anything that can be done to a bald pate has been tried to stimulate hair growth. The ancient Egyptians were fond of rancid crocodile or hippo fat. If it smelled bad, surely it must do some good. It didn't. Cleopatra experimented with a goo made of ground horse teeth and deer marrow to spur Julius Caesar's dormant

hair follicles into action. When this didn't work she traded him in for Mark Antony. During the Victorian era cold tea was brushed on the scalp, followed by citrus juice. In farming areas chickens were persuaded to leave deposits on a bald head and cows to lick it. Electric combs, suction caps and paint thinner have been tried. At a secluded farmhouse in Pennsylvania, Marcella Ferens rakes a glass instrument filled with a purple gas across the head to "sterilize the scalp." Then the subject holds a wire attached to some electrical machine while the operator holds a second wire as she massages the bald area with a secret formula. This forces the formula into the scalp. Some infomercials push shampoos with special emulsifiers to clean follicles as if baldness were due to plugged follicles. Others use jumbled language to promote spray paint to cover bald spots. The truth is that only Rogaine (minoxidil) rubbed on the scalp or Propecia (finasteride) taken orally have shown any effect in growing hair. Even with these the results are not impressive. The Bald Headed Men of America, headquartered appropriately in Morehead, North Carolina, was started when the founder was refused a job because he was bald. They take a different tack. If you want to waste your hormones growing hair....go ahead" Actually this is a wrong statement because it is high levels of dihydrotestosterone that can cause baldness. They are on firmer footing with their slogan. No rugs or drugs.

Aristotle used Goat Urine and Hippocrates recommended Pigeon droppings to cure baldness.

<http://dazeinfo.com/2010/06/22/superstitions-across-different-countries-an-overview/>

Australians bathed inside rotting whales to 'cure' rheumatism

The Australian National Maritime Museum has revealed that sufferers of rheumatism were once advised to sit inside the festering carcasses of whales in order to relieve their symptoms.

The museum has recently opened a new exhibit in Sydney, which seeks to uncover the diversity, origins and adaptation of whales, charting their development from land mammals to aquatic giants. The exhibition, entitled "Amazing Whales" also looks at the different relationships humans have had with the cetaceans, which includes their apparent medicinal qualities.

Those afflicted with rheumatism were advised to sit inside the belly of a dead whale for approximately 30 hours. If the patient could stay the course and withstand this bizarre practice, they were promised at least 12 months of relief from pain.

<http://www.wired.co.uk/article/whale-bath>

Weird Bizarre superstitions to cure disease

<http://www.historyextra.com/feature/animals/10-historical-superstitions-we-carry-today>

<http://listverse.com/2013/01/21/10-crazy-cures-for-the-black-death/>

Millions of People are making money out of superstitions of Fools

Rebirthing Therapy, Reiki, Energy-Deflecting Golfer Pendant, Maggot Debridement Therapy, Leech Therapy, Beer spas, Ozone Anti-Aging the list is very big.

<http://webecoist.momtastic.com/2010/07/05/12-most-bizarre-modern-alternative-medical-treatments/>

<http://oddrandomthoughts.com/strange-and-bizarre-medicine-and-cures/>

<http://www.stylist.co.uk/life/13-strange-superstitions>

So in simple words instead of taking opinions of Stupid Fools, or wasting any time arguing with them Let study science correctly, without bias !

Aristotle is yet Famous, because Girls come to know about his name in school text books. Though not sure why !

Newton 's Law of Cooling by Prof. Subhashish Chattopadhyay SKMClasses Bangalore Useful for IIT-JEE, CBSE, I.Sc. PU-II, Boards, CET, CEE, PET, IGCSE IB AP-Physics and other exams

Aristotle told at-least one statement correct !

**"The female is a female by virtue of a certain lack of qualities;
we should regard the female nature as afflicted with a natural defectiveness."**

-Aristotle

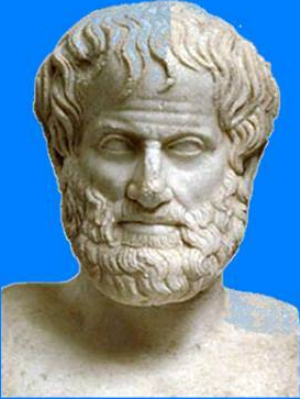

♂

ΛΟΓΙΧ. ΣΤΡΕΝΓΗΤΗ. ΗΟΝΟΡ.



Newton 's Law of Cooling by Prof. Subhashish Chattopadhyay SKMClasses Bangalore Useful for IIT-JEE, CBSE, I.Sc. PU-II, Boards, CET, CEE, PET, IGCSE IB AP-Physics and other exams

Newton 's Law of Cooling by Prof. Subhashish Chattopadhyay SKMClasses Bangalore Useful for IIT-JEE, CBSE, I.Sc. PU-II, Boards, CET, CEE, PET, IGCSE IB AP-Physics and other exams



The monkeys in the previous page were all Female Monkeys

Aristotle was not correct (though not sure), Women are not missing anything No one is voting for Aristotle.

Not wrong as well (though not sure), very difficult to prove either way!

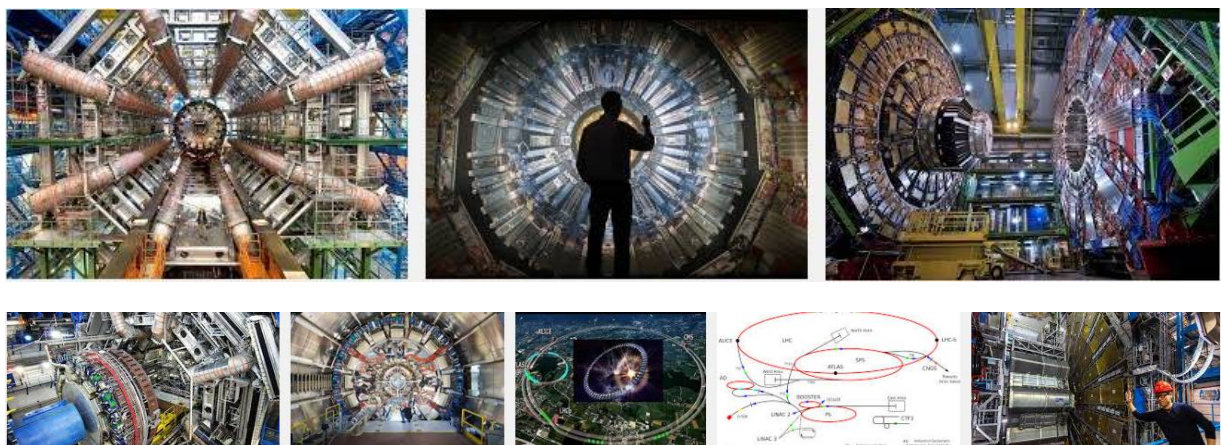

Newton 's Law of Cooling by Prof. Subhashish Chattopadhyay SKMClasses Bangalore Useful for IIT-JEE, CBSE, I.Sc. PU-II, Boards, CET, CEE, PET, IGCSE IB AP-Physics and other exams

Newton 's Law of Cooling by Prof. Subhashish Chattopadhyay SKMClasses Bangalore Useful for IIT-JEE, CBSE, I.Sc. PU-II, Boards, CET, CEE, PET, IGCSE IB AP-Physics and other exams

Most important physics experiments ([that a certain kind of Apes conducted](#)) can be seen at

See <http://www.explainthatstuff.com/great-physics-experiments.html>

<http://physics-animations.com/Physics/English/top10.htm>

https://en.wikipedia.org/wiki/List_of_experiments

<https://www.quora.com/What-are-some-of-the-most-important-experiments-in-physics>

Though my list will be as follows -

Michelson-Morley experiment proving there was no Aether, Measurement of e/m then e (charge of electron) and m (mass of electron), Fizeau's method of measuring the speed of light, Moseley 's experiment with X-Rays to discover Protons, Jagadish chandra Bose demonstrating controlled emission / transmission and receiving of Radio waves, Casimir experiments to show Casimir forces of virtual particles, Edington measuring bending of light, Flying atomic clocks in planes and confirming slowing down of time at high speeds, Victor Hess measured Radiation level variation at ground and high up in the atmosphere, Soviet physicist Sergey Vernov was the first to use radiosondes to perform cosmic ray readings with an instrument carried to high altitude by a balloon at heights up to 13.6 km, The proof of time dilation by Muon decay <https://debunkingrelativity.com/muons-time-dilation/> , Measurement of Space-time curvature near Earth and thereby the stress-energy tensor (which is related to the distribution and the motion of matter in space) in and near Earth https://en.wikipedia.org/wiki/Gravity_Probe_B , Detecting Gravitational Waves.

[In 1909 Theodor Wulf developed an electrometer, a device to measure the rate of ion production inside a hermetically sealed container, and used it to show higher levels of radiation at the top of the Eiffel Tower than at its base. However, his paper published in *Physikalische Zeitschrift* was not widely accepted. In 1911 Domenico Pacini observed simultaneous variations of the rate of ionization over a lake, over the sea, and at a depth of 3 meters from the surface. Pacini concluded from the decrease of radioactivity underwater that a certain part of the ionization must be due to sources other than the radioactivity of the Earth. In 1912, Victor Hess carried three enhanced-accuracy Wulf electrometers to an altitude of 5300 meters in a free balloon flight. He found the ionization rate increased approximately fourfold over the rate at ground level. Hess ruled out the Sun as the radiation's source by making a balloon ascent during a near-total eclipse. With the moon blocking much of the Sun's visible radiation, Hess still measured rising radiation at rising altitudes. He concluded "The results of my observation are best explained by the assumption that a radiation of very great penetrating power enters our atmosphere from above." In 1913-1914, Werner Kolhörster confirmed Victor Hess' earlier results by measuring the increased ionization rate at an altitude of 9 km. Hess received the Nobel Prize in Physics in 1936 for his discovery. Homi J. Bhabha derived an expression for the probability of scattering positrons by electrons, a process now

Newton 's Law of Cooling by Prof. Subhashish Chattopadhyay SKMClasses Bangalore Useful for IIT-JEE, CBSE, I.Sc. PU-II, Boards, CET, CEE, PET, IGCSE IB AP-Physics and other exams

Newton 's Law of Cooling by Prof. Subhashish Chattopadhyay SKMClasses Bangalore Useful for IIT-JEE, CBSE, I.Sc. PU-II, Boards, CET, CEE, PET, IGCSE IB AP-Physics and other exams

known as Bhabha scattering. His classic paper, jointly with Walter Heitler, published in 1937 described how primary cosmic rays from space interact with the upper atmosphere to produce particles observed at the ground level. Bhabha and Heitler explained the cosmic ray shower formation by the cascade production of gamma rays and positive and negative electron pairs. Soviet physicist Sergey Vernov was the first to use radiosondes to perform cosmic ray readings with an instrument carried to high altitude by a balloon. On 1 April 1935, he took measurements at heights up to 13.6 kilometers using a pair of Geiger counters in an anti-coincidence circuit to avoid counting secondary ray showers.]

See https://en.wikipedia.org/wiki/Cosmic_ray

<http://web.mit.edu/8.13/www/JLExperiments/JLExp14.pdf>

<http://web.mit.edu/lululiu/Public/pixx/not-pixx/muons.pdf>

https://en.wikipedia.org/wiki/Time_dilation

<http://www.physics.rutgers.edu/ugrad/389/muon/muonphysics.pdf>

<http://www2.fisica.unlp.edu.ar/~veiga/experiments.html>

Detecting Neutrons

Rutherford predicted the existence of the neutron in 1920. Twelve years later, his assistant James Chadwick found it. At Cambridge, Chadwick searched for the neutron. He tried in 1923, but did not find it. He tried again in 1928, with no success. In 1930, the German physicists Walther Bothe and Herbert Becker noticed something odd. When they shot alpha rays at beryllium (atomic number 4) the beryllium emitted a neutral radiation that could penetrate 200 millimeters of lead. In contrast, it takes less than one millimeter of lead to stop a proton. Bothe and Becker assumed the neutral radiation was high-energy gamma rays.

Marie Curie's daughter, Irene Joliot-Curie, and Irene's husband, Frederic, put a block of paraffin wax in front of the beryllium rays. They observed high-speed protons coming from the paraffin. They knew that gamma rays could eject electrons from metals. They thought the same thing was happening to the protons in the paraffin. Chadwick said the radiation could not be gamma rays. To eject protons at such a high velocity, the rays must have an energy of 50 million electron volts. An electron volt is a tiny amount of energy, only enough to keep a 75-watt light bulb burning for a tenth of a trillionth of a second. The alpha particles colliding with beryllium nuclei could produce only 14 million electron volts.

The law of conservation of energy states that energy can neither be created nor destroyed. It certainly looked as if energy was being created along with the neutral radiation. Chadwick had another explanation for the beryllium rays. He thought they were neutrons. He set up an experiment to test his hypothesis.

Newton 's Law of Cooling by Prof. Subhashish Chattopadhyay SKMClasses Bangalore Useful for IIT-JEE, CBSE, I.Sc. PU-II, Boards, CET, CEE, PET, IGCSE IB AP-Physics and other exams

Newton 's Law of Cooling by Prof. Subhashish Chattopadhyay SKMClasses Bangalore Useful for IIT-JEE, CBSE, I.Sc. PU-II, Boards, CET, CEE, PET, IGCSE IB AP-Physics and other exams

Chadwick put a piece of beryllium in a vacuum chamber with some polonium. The polonium emitted alpha rays, which struck the beryllium. When struck, the beryllium emitted the mysterious neutral rays.

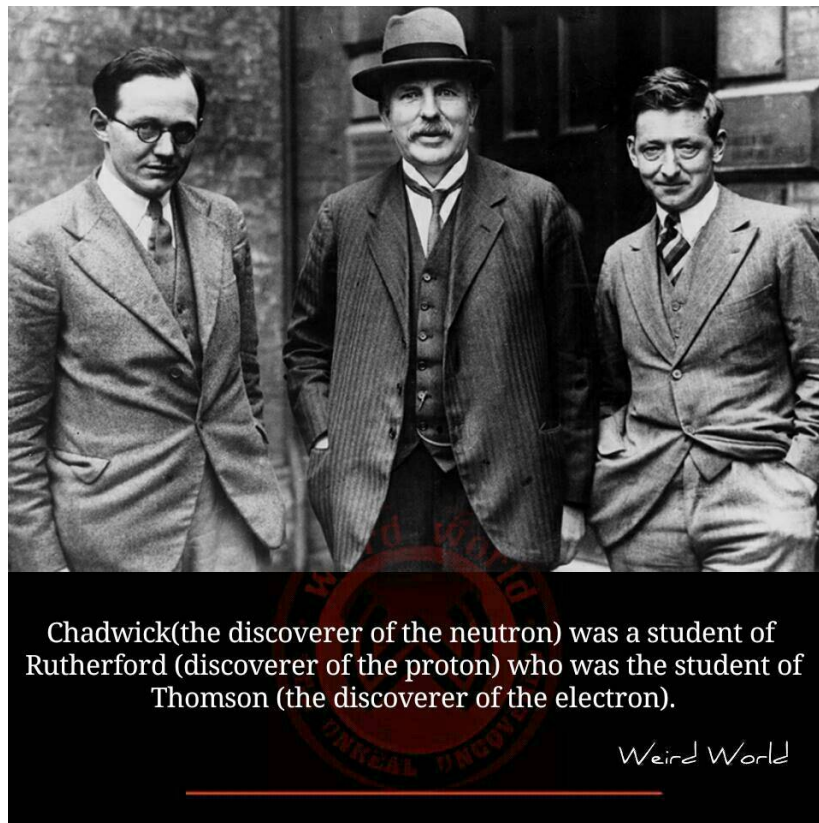

In the path of the rays, Chadwick put a target. When the rays hit the target, **they knocked atoms out of it.** The atoms, which became electrically charged in the collision, flew into a detector. Chadwick's detector was a chamber filled with gas. When a charged particle passed through the chamber, it ionized the gas molecules. The ions drifted toward an electrode. **Chadwick measured the current flowing through the electrode. Knowing the current, he could count the atoms and estimate their speed.** Chadwick used targets of different elements, measuring the energy needed to eject the atoms of each. Gamma rays could not explain the speed of the atoms. The only good explanation for his result was a neutral particle. **To prove that the particle was indeed the neutron, Chadwick measured its mass.** He could not weigh it directly. Instead he measured everything else in the collision and used that information to calculate the mass.

For his mass measurement, Chadwick bombarded boron with alpha particles. Like beryllium, boron emitted neutral rays. Chadwick placed a hydrogen target in the path of the rays. When the rays struck the target, protons flew out. Chadwick measured the velocity of the protons.

Newton 's Law of Cooling by Prof. Subhashish Chattopadhyay SKMClasses Bangalore Useful for IIT-JEE, CBSE, I.Sc. PU-II, Boards, CET, CEE, PET, IGCSE IB AP-Physics and other exams

Newton 's Law of Cooling by Prof. Subhashish Chattopadhyay SKMClasses Bangalore Useful for IIT-JEE, CBSE, I.Sc. PU-II, Boards, CET, CEE, PET, IGCSE IB AP-Physics and other exams

Using the laws of conservation of momentum and energy, Chadwick calculated the mass of the neutral particle. It was 1.0067 times the mass of the proton. The neutral radiation was indeed the long-sought neutron.

<http://ansnuclearcafe.org/2011/10/19/pioneers102011/>

100 Greatest Discoveries of Physics

<https://www.youtube.com/watch?v=Bpid0LBTqWg>

(**As I write these words { 2016 } GUT [General Unified Theory] is being modified to introduce a 5th fundamental force, because some heavy particles have been observed at CERN and various other experiments and Producing Gravitational waves at will, without mass, Madala Bosons to explain Dark Matter)**



Learn Science from <https://www.youtube.com/user/cassiopeiaproject/videos>

Some easy Physics (much easier than IIT-JEE)

https://www.youtube.com/channel/UCliSRiiRVQuDfgxl_QN_Fmw/videos

<https://www.youtube.com/watch?v=VCVTk5yzo0g&list=PLB03A41EA88A8DE65>

<https://www.youtube.com/user/diggitydev/playlists>

<https://www.youtube.com/user/onlearningcurve/playlists>

<https://www.youtube.com/watch?v=qWu82nJS42I&list=PLF71B362214423F9D>

<https://www.youtube.com/user/FizziksGuy/playlists>

<https://www.youtube.com/watch?v=glOTFjq76tM&list=PL3plurvIhuSANBIZa3u0RP9GFQprISN11>

<https://www.youtube.com/watch?v=y7fXEKCP2XU&list=PL3plurvIhuSDjUvzNZwC1HBW9eY1qldno>

<https://www.youtube.com/channel/UCiEHVhv0SBMpP75JbzJShqw/playlists>

(Pradeep Kshetrapal Sir's Videos are at -

<https://www.youtube.com/user/PradeepKshetrapal/videos>)

Lectures by Professor Robert Riggs

<https://www.youtube.com/watch?v=RWqAjKFKH3o&list=PL01771E7CE99097F8>

Newton 's Law of Cooling by Prof. Subhashish Chattopadhyay SKMClasses Bangalore Useful for IIT-JEE, CBSE, I.Sc. PU-II, Boards, CET, CEE, PET, IGCSE IB AP-Physics and other exams

Newton 's Law of Cooling by Prof. Subhashish Chattopadhyay SKMClasses Bangalore Useful for IIT-JEE, CBSE, I.Sc. PU-II, Boards, CET, CEE, PET, IGCSE IB AP-Physics and other exams

Lectures by Professor Jerzy Wrobel

<https://www.youtube.com/watch?v=DFhdUQ9AZw4&list=PLEEB9EC9DD59D6D85>

Lectures by Yuri-Kolomensky

https://www.youtube.com/watch?v=KEiYSQnMHHQ&list=PL-XXv-cvA_iAKxxGD1tiWLS0DcieGLHh0

Physics Videos from Berkeley

<https://www.youtube.com/watch?v=a-0h-9KCGjo&list=PLr11xUV7FM0EDu3u28Zp3d4ffjppqROm5Y>

Lectures by Professor Muller

https://www.youtube.com/watch?v=6ysbZ_j2xi0&list=PL09717125E8C05BFC

Lectures by Steven W. Stahler

https://www.youtube.com/watch?v=Uc9Q5hNpv4Q&list=PL-XXv-cvA_iB1IYkU1YcdLCranBB0woKX

Lectures by Michel van Biezen

<https://www.youtube.com/watch?v=FkO6vyMqo8E&list=PLX2qX-ftPVXVCw9WxxEA4yD14k8yskTSj>

Dr. Don Lincoln of Fermilab <https://www.youtube.com/user/fermilab/videos>

Advance Physics Lectures by Leonard Susskind

https://www.youtube.com/watch?v=pyX8kQ-JzHI&list=PLQrxdul9Pds1fm91Dmn8x1Io-O_kpZGk8

A kid who wants more fun

https://www.youtube.com/watch?v=p_o4aY7xkXg&list=PL908547EAA7E4AE74

https://www.youtube.com/watch?v=51GNAET2zFU&list=PLIIVwaZQkS2rxqMXTH-cdEOLIX9Zi_oS1

<https://www.youtube.com/watch?v=h0hwuyOmd4k&list=PLSBNC6ROBP12PUanbUNaVLhNbJR6rgbmm>

-

Newton 's Law of Cooling by Prof. Subhashish Chattopadhyay SKMClasses Bangalore Useful for IIT-JEE, CBSE, I.Sc. PU-II, Boards, CET, CEE, PET, IGCSE IB AP-Physics and other exams

Newton 's Law of Cooling by Prof. Subhashish Chattopadhyay SKMClasses Bangalore Useful for IIT-JEE, CBSE, I.Sc. PU-II, Boards, CET, CEE, PET, IGCSE IB AP-Physics and other exams

IIT-JEE is extremely tough for most humans. A productive PhD in Physics, or actually contributing to growth of the subject is much more tougher (than IIT JEE). { I personally know quite a few IIT-JEE single or double digit rankers, joining for PhD and then dropped out due to performance }. **Most people have an illusion that they can argue with Scientists and imagine to ask some " smart " questions which the Scientists will not able to answer, so the argument is won, and existence of God is proved.** As if Scientist are eagerly sitting or waiting to answer every crap asked. I can only say; that most scientists (since more than 100 years) have stopped wasting their time arguing or convincing fools. I am not a Scientist. Even being a simple teacher, I do not try to teach fools, or argue with anyone.

[**For History of Physics I recommend**

<http://www.historyworld.net/wrldhis/PlainTextHistories.asp?ParagraphID=kqq>]

[Gravitational lens and Einstein ring due to bending of light by mass]

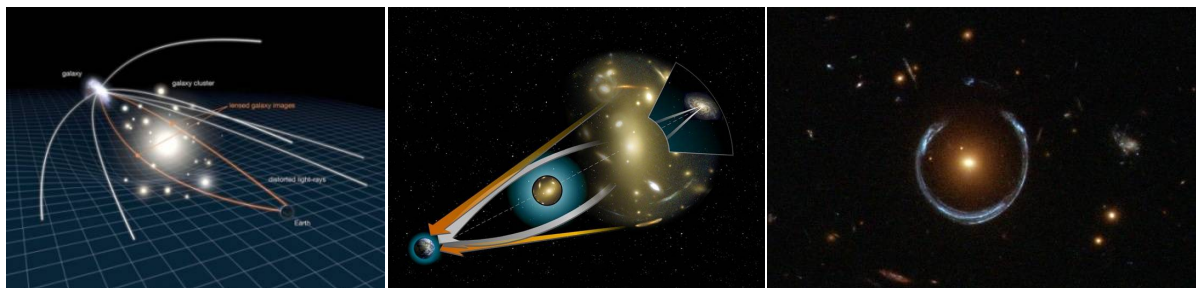

Recall what I said at the beginning of the book " **Someone will learn only by his hard work, his desire to learn.** " No arguments or no 'time wasting' with fools. There is too much of good material (data, books, videos etc) out and free in this world. If someone wants to learn, can learn; **instead of wasting time arguing.** Since centuries stupid and/or fools are being eliminated in various exams. Entrance exam, is a misnomer. These are elimination tests. The society has systems of Interviews, Peer reviews, appraisals, Thesis evaluation etc... to eliminate crap, foolish things, and nonsense.



Newton 's Law of Cooling by Prof. Subhashish Chattopadhyay SKMClasses Bangalore Useful for IIT-JEE, CBSE, I.Sc. PU-II, Boards, CET, CEE, PET, IGCSE IB AP-Physics and other exams

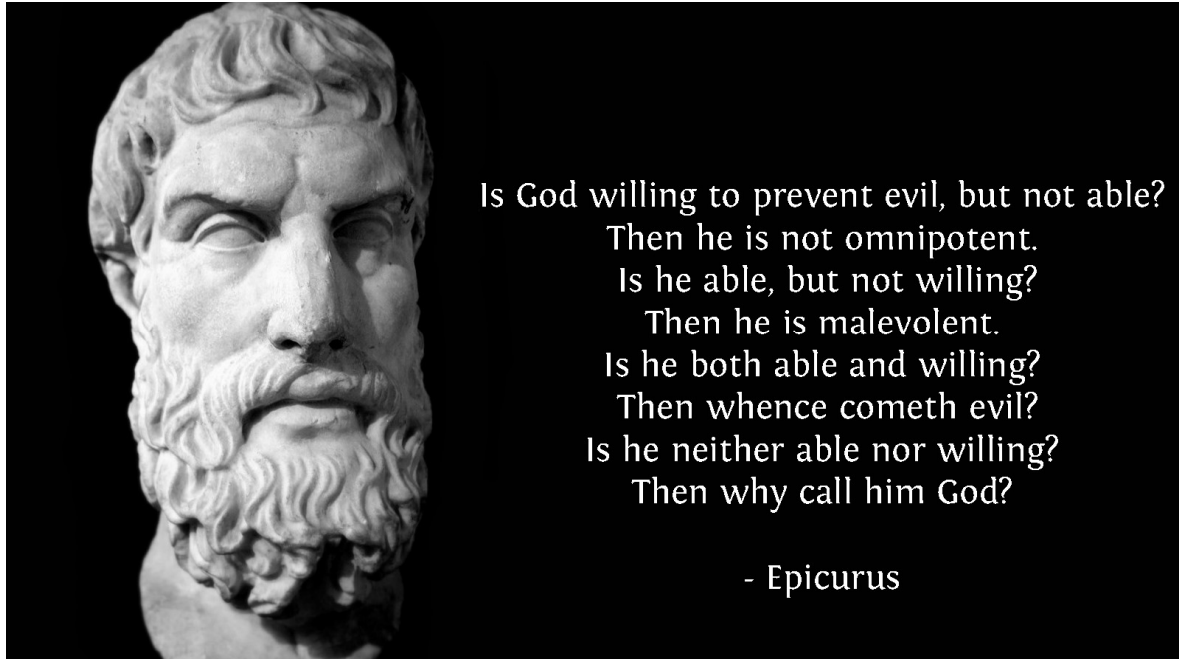

Religion and/or " war between religions " mostly to decide whose God is better; have killed millions. Instead of fighting and killing; to decide which custom to follow; how to dress; what rituals to do on a daily basis; better to spend time experimenting and developing new things, new technologies, new ideas. Scientists (**the men**) are busy; and **always will be busy!** **Rather, in war; with new frontiers of knowledge;** not in arguments, verbal wars, or physical wars. **Atheism is the most peaceful Doctrine.**

"**Bertrand Arthur William Russell**" the famous Philosopher, Mathematician, Logician, received 1950 Nobel Prize for Literature.

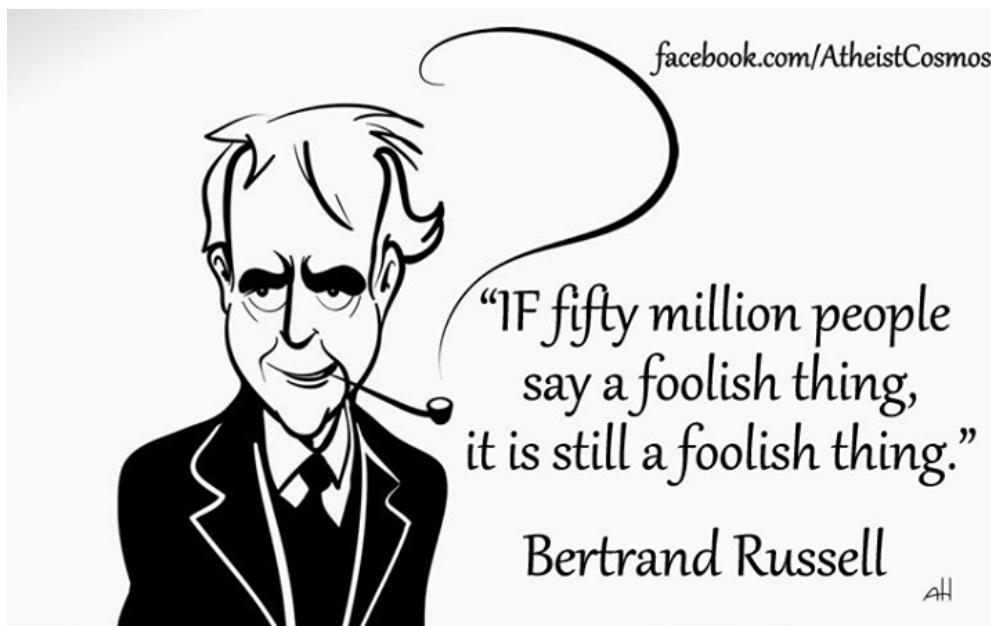

Newton 's Law of Cooling by Prof. Subhashish Chattopadhyay SKMClasses Bangalore Useful for IIT-JEE, CBSE, I.Sc. PU-II, Boards, CET, CEE, PET, IGCSE IB AP-Physics and other exams

So those who want to learn can continue learning ...

See https://www.youtube.com/results?search_query=History+of+science

See

https://www.youtube.com/results?search_query=history+of+science+the+complete+full+documentary+

I will choose only two extreme examples of what Human beings have " **seen** " by now ...

For far and big) Very powerful cameras ready with video recording facilities were scanning the sky. Coincidentally the "place or region " a camera was looking had an event (many million years back though) of a black hole devouring a star.

<https://www.youtube.com/watch?v=O3Z5AS3TTS4>

<https://www.youtube.com/watch?v=x7ZX10UbMus>

For small) Photographs of molecules and subsequently atoms

<https://www.youtube.com/watch?v=yqLlglaz1L0>

<https://www.youtube.com/watch?v=ofp-OHlq6Wo>

<https://www.youtube.com/watch?v=oSCX78-8-q0>

<https://www.youtube.com/watch?v=RTLeWlqynW4>

<https://www.youtube.com/watch?v=J3xLuZNKhIY>

<https://www.youtube.com/watch?v=SMgi2j9Ks9k>

https://www.youtube.com/watch?v=V0KjXsGRvoA&list=PLC3E0tG-9im_kuMwYIM7-NZR62VyWZ6rl

-

Entertainment and relaxed mind is required. Students can improve Visual Presentation skills by watching "Two men and wardrobe" by Roman Polanski

<https://www.youtube.com/watch?v=Cs2RZewMuAg>

Imagine a world where Millions of People have "**better**" Visual story telling or Visual presentation skills than **Roman Polanski** or say **Jim Jarmusch** ...

<https://www.youtube.com/watch?v=wJS2mC-7LSM>

Enjoy

-

Newton 's Law of Cooling by Prof. Subhashish Chattopadhyay SKMClasses Bangalore Useful for IIT-JEE, CBSE, I.Sc. PU-II, Boards, CET, CEE, PET, IGCSE IB AP-Physics and other exams

Newton 's Law of Cooling by Prof. Subhashish Chattopadhyay SKMClasses Bangalore Useful for IIT-JEE, CBSE, I.Sc. PU-II, Boards, CET, CEE, PET, IGCSE IB AP-Physics and other exams

Spoon Feeding Series - Newton 's Law of Cooling

History of Newton 's Law of Cooling

<http://tuhsphysics.ttsd.k12.or.us/Research/ib01/IrlaTonl/>

http://amsi.org.au/ESA_Senior_Years/SeniorTopic3/3e/3e_4history_3.html

https://en.wikipedia.org/wiki/Newton%27s_law_of_cooling

-

Pradeep Kshetrapal Sir 's Videos

https://www.youtube.com/watch?v=x-mj96Qtur8&list=PLJZk2__oyAliUslzFsT6oo_9Em3Bkc0Zb&index=13

-

Guruprakash Sir 's Videos

<https://www.youtube.com/watch?v=vk1gWbvX7g4&list=PLF841B27ADBFDAC0C>

-

Subhashish Sir 's Videos

<https://archive.org/details/7NumericalOnNewtonsLawOffCooling150DegTo40DegIn5MinsPhysi/csZookeeper>

:-{D

Newton 's Law of Cooling by Prof. Subhashish Chattopadhyay SKMClasses Bangalore Useful for IIT-JEE, CBSE, I.Sc. PU-II, Boards, CET, CEE, PET, IGCSE IB AP-Physics and other exams

Newton 's Law of Cooling by Prof. Subhashish Chattopadhyay SKMClasses Bangalore Useful for IIT-JEE, CBSE, I.Sc. PU-II, Boards, CET, CEE, PET, IGCSE IB AP-Physics and other exams

Appendix :

The word Appendix is from mid 16 th century Latin word Appendere meaning hang upon. Apart from the hanging body part; which is not needed by us now; We all know; it also means, supplementary material at the end of a book, article, document, or other text, usually of an explanatory, statistical, or bibliographic nature.

[in simple words Appendix is extra, and may not exactly be needed].

Almost all authors, including me, feel, that something more can be here. Not everything was supposed to be at the beginning. It is not possible to put everything at the beginning, nor that should be done.

I reserved this place for my personal idea, and lots of reading that I did regarding that.

When I was **in school** (1980s) it occurred to me, why not in movies, we keep a "smell track" as well. Everyone knows history of movies Then came talkies, then color, music, dance ... song sequels.

Well, why not a hero and heroine, as they dance in a park, (with melodious song, and enchanting music) they be in various parts of the beautiful gardens. At various parts they get nice smells, and the "smell track" emits the smells for the Audience.

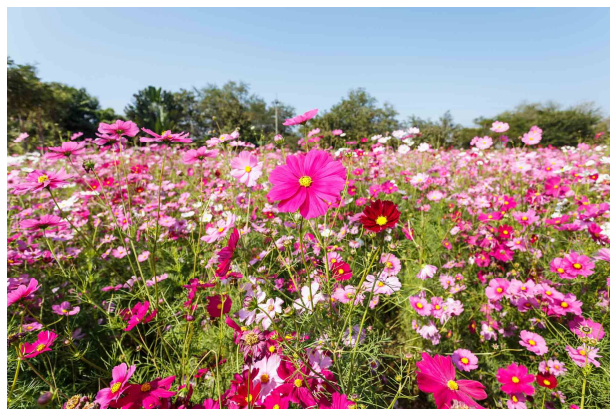

Technically this needed many steps or parts. Sniffers as "cameras of Smells", smell spectrum definition, (similar to RGB where combination in various ratio can give us various colour, combination of some smell blocks may give various smells), emitting the required smell, and flushing the molecules out of the room, to allow next smell sequel to come etc.

Many years later (in 1990s) in a movie hall in Chennai **some great minds** conducted an experimental show. Many kinds of essence sticks, and smell sources such as scents, were taken in various combinations. A smell emitter blew the "smell", time to time as per the sequence in the movie. The exhaust fans kept flushing out the "older" molecules!

This is pretty costly, clumsy, and surely slow. The scan rate we have in ultrafast cameras can be crore frames per second. While scanning smell, say in a scene of cooking, or eating, or in a

Newton 's Law of Cooling by Prof. Subhashish Chattopadhyay SKMClasses Bangalore Useful for IIT-JEE, CBSE, I.Sc. PU-II, Boards, CET, CEE, PET, IGCSE IB AP-Physics and other exams

Newton 's Law of Cooling by Prof. Subhashish Chattopadhyay SKMClasses Bangalore Useful for IIT-JEE, CBSE, I.Sc. PU-II, Boards, CET, CEE, PET, IGCSE IB AP-Physics and other exams

park, it has to be very slow. May be, a change of smell once a minute be tolerable. If it is a "smell music" ... then every 5-10 seconds a change may be tried.

A Japanese company made a cellphone which emitted different smells depending on the calling id. Commonly we can set different ring tones for every caller. In this equipment an old deaf man could set an "**obnoxious smell**" for the calls from his wife. Let people decide the smell which represent various characters in their life.

[A (software) virus may emit smells in random from a phone of this kind.... Particularly Badboo. Or "remains" of a sweet smell may tell who called even if the caller history is cleaned]

<https://www.techinasia.com/japan-chatperf>

<https://www.techinasia.com/scentee-mobile-app-that-emits-smell>

<http://www.japantimes.co.jp/news/2013/10/16/business/corporate-business/firm-wants-your-smartphone-to-smell/#.V9bjr63yDIU>



(Cyrano - is a "digital smell speaker" and the endeavor from Harvard professor and serial inventor, David Edwards) <http://www.hotsaucedrops.com/?author=91>

<https://textually.org/textually/archives/2007/01/014726.htm>

<http://www.theneweconomy.com/technology/using-mobiles-to-smell-how-technology-is-giving-us-our-senses-video>

Newton 's Law of Cooling by Prof. Subhashish Chattopadhyay SKMClasses Bangalore Useful for IIT-JEE, CBSE, I.Sc. PU-II, Boards, CET, CEE, PET, IGCSE IB AP-Physics and other exams

Newton 's Law of Cooling by Prof. Subhashish Chattopadhyay SKMClasses Bangalore Useful for IIT-JEE, CBSE, I.Sc. PU-II, Boards, CET, CEE, PET, IGCSE IB AP-Physics and other exams

Extremely sensitive smell sensors are available.

<http://www.japantimes.co.jp/news/2016/06/23/world/science-health-world/nose-job-smells-smart-sensors-last-frontier/#.V9bkGa3yDIU>

<https://books.google.co.in/books?id=odT-BAAAQBAJ&pg=PA8&lpg=PA8&dq=smell+spectrum+detection+and+reproduction&source=bl&ots=a4pyDI8CZy&sig=kZ--x5qeo3V4tKTlzV7vkyGrgpA&hl=en&sa=X&ved=0ahUKEwjelb7xq4rPAhUDpJOKHS7pDyEQ6AEISjAJ#v=onepage&q=smell%20spectrum%20detection%20and%20reproduction&f=false>

<http://www.extremetech.com/extreme/146986-olfactory-breakthrough-a-theory-of-quantum-smell>

Quantum smelling Devices, and various kinds of Artificial Nose have been made

<http://www.enose.nl/rd/technology/>

<https://www.theguardian.com/science/2014/apr/02/electronic-noses-explainer-sniffing-disease>

<http://www.popsci.com/science/article/2013-01/bolstered-new-study-quantum-smell-theory-olfactory-sense-gains-traction>



Luca Turin in king of Smell

Luca is one of the very rare persons, who has understood the secrets of smell, the best!

https://www.ted.com/talks/luca_turin_on_the_science_of_scent?language=en

<http://www.sjsu.edu/faculty/watkins/turin.htm>

You can go to market, and buy a few different kinds of scents, then make a combination. If you give this combination to Luca, he can make 3 or 4 different molecules which will smell the same. It is your choice to synthesize one or more kind of molecules, as production cost / efficiency / complexity / raw material availability etc.

-

Newton 's Law of Cooling by Prof. Subhashish Chattopadhyay SKMClasses Bangalore Useful for IIT-JEE, CBSE, I.Sc. PU-II, Boards, CET, CEE, PET, IGCSE IB AP-Physics and other exams

About cryptochromes

Magnetic sensing is a type of sensory perception that has long captivated the human imagination, although it seems inaccessible to humans. Over the past 50 years, scientific studies have shown that a wide variety of living organisms have the ability to perceive magnetic fields and can use information from the earth's magnetic field in orientation behavior. Examples abound: salmon (*Oncorhynchus nerka*), sea turtles (*Dermochelys coriacea*), spotted newts (*Notophthalmus viridescens*), lobsters (*Panulirus argus*), honeybees (*Apis mellifera*), and fruitflies (*Drosophila melanogaster*) can all perceive and utilize geomagnetic field information. But perhaps the most well-studied example of animal magnetoreception is the case of migratory birds (e.g. European robins (*Erithacus rubecula*), silvereyes (*Zosterops l. lateralis*), garden warblers (*Sylvia borin*)), who use the earth's magnetic field, as well as a variety of other environmental cues, to find their way during migration.

<https://www.sciencedaily.com/releases/2016/06/160606100519.htm>

The avian magnetic compass is a complex entity with many surprising properties. The basis for the magnetic sense is located in the eye of the bird, and furthermore, it is light-dependent, i.e., a bird can only sense the magnetic field if certain wavelengths of light are available. Specifically, many studies have shown that birds can only orient if blue light is present. The avian compass is also an inclination-only compass, meaning that it can sense changes in the inclination of magnetic field lines but is not sensitive to the polarity of the field lines. Under normal conditions, birds are sensitive to only a narrow band of magnetic field strengths around the geomagnetic field strength, but can orient at higher or lower magnetic field strengths given accommodation time.

The blue light receptors cryptochromes mediate various light responses in plants. The photoexcited cryptochrome molecules undergo a number of biophysical and biochemical changes, including electron transfer, phosphorylation, and ubiquitination, resulting in conformational changes to propagate light signals. Two modes of cryptochrome signal transduction have been recently discovered, the CIB (cryptochrome-interacting basic-helix-loop-helix 1)-dependent CRY2 regulation of transcription and the SPA1/COP1 (SUPPRESSOR OF PHYA /CONSTITUTIVELY PHOTOMORPHOGENIC1)-dependent cryptochrome regulation of proteolysis. Both cryptochrome signaling pathways rely on blue light-dependent interactions between the cryptochrome photoreceptor and its signaling proteins to modulate gene expression changes in response to blue light, leading to altered developmental programs of plants.

Cryptochromes (from the Greek κρυπτός χρώμα, "hidden colour") are a class of flavoproteins that are sensitive to blue light. They are found in plants and animals. Cryptochromes are involved in the circadian rhythms of plants and animals, and in the sensing of magnetic fields in a number of species.

THE BIOLOGY OF MAGNETORECEPTION

One theory for the mechanism behind the magnetic sense is that animals have cells containing collections of magnetite crystals that respond to external magnetic fields. Those cells have proven hard to find, but last year researchers found cells in the snouts of rainbow trout that, when suspended in liquid, rotated in sync with a rotating magnetic field **1**.

On closer inspection, it was clear that the rotating cells contained magnetite crystals attached to the cell membrane **2**.

Magnetic cells have yet to be identified in homing pigeons, but last year another group found that neurons in a brain region linked to the inner ear were activated in response to magnetic fields, suggesting that magnetoreceptor cells may be found in the inner ear. Researchers have hypothesized that such cells may be situated between sensory hair cells in the lagena, a structure located in the inner ear **3**.

If so, when the magnetite-containing structure aligns to a change in the direction of the magnetic field (in relation to the bird's head), it would twist and apply mechanical pressure on the cell membrane **4**. This would open ion channels, changing the electrical potential across the membrane **5** and triggering a nerve impulse.

The same signal transduction mechanism could also work in the trout because their magnetic cells are locked in a matrix within the olfactory epithelium, where mechanosensitive neurons connect to the brain via the trigeminal nerve **6**. But it's not yet clear whether these magnetic cells are neurons.

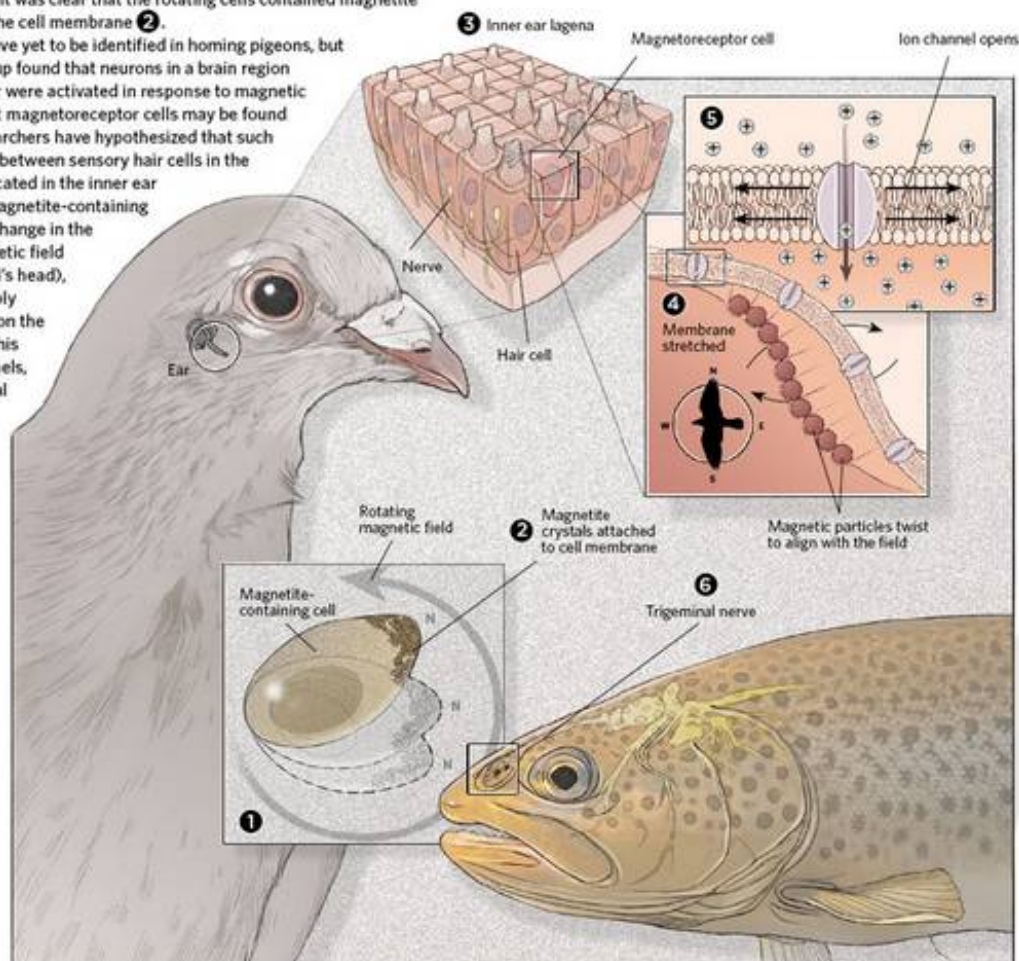

So Cryptochromes are photoreceptors that regulate entrainment by light of the circadian clock in plants and animals. They also act as integral parts of the central circadian oscillator in animal brains and as receptors controlling photomorphogenesis in response to blue or ultraviolet (UV-A) light in plants. Cryptochromes are probably the evolutionary descendents of DNA photolyases, which are light-activated DNA-repair enzymes, and are classified into three groups - plant cryptochromes, animal cryptochromes, and CRY-DASH proteins. Cryptochromes and photolyases have similar three-dimensional structures, characterized by an α/β domain and a helical domain. The structure also includes a chromophore, flavin adenine dinucleotide (FAD). The FAD-access cavity of the helical domain is the catalytic site of photolyases, and it is predicted also to be important in the mechanism of cryptochromes. Cryptochromes are photolyase-like blue light receptors originally discovered in Arabidopsis but later found in other plants, microbes, and animals. Arabidopsis has two cryptochromes, CRY1 and CRY2, which mediate primarily blue light inhibition of hypocotyl elongation and photoperiodic control of floral initiation, respectively. In addition, cryptochromes also regulate over a dozen

Newton 's Law of Cooling by Prof. Subhashish Chattopadhyay SKMClasses Bangalore Useful for IIT-JEE, CBSE, I.Sc. PU-II, Boards, CET, CEE, PET, IGCSE IB AP-Physics and other exams

other light responses, including circadian rhythms, tropic growth, stomata opening, guard cell development, root development, bacterial and viral pathogen responses, abiotic stress responses, cell cycles, programmed cell death, apical dominance, fruit and ovule development, seed dormancy, and magnetoreception. Cryptochromes have two domains, the N-terminal PHR (Photolyase-Homologous Region) domain that bind the chromophore FAD (flavin adenine dinucleotide), and the CCE (CRY C-terminal Extension) domain that appears intrinsically unstructured but critical to the function and regulation of cryptochromes. Most cryptochromes accumulate in the nucleus, and they undergo blue light-dependent phosphorylation or ubiquitination. It is hypothesized that photons excite electrons of the flavin molecule, resulting in redox reaction or circular electron shuttle and conformational changes of the photoreceptors. The photoexcited cryptochrome are phosphorylated to adopt an open conformation, which interacts with signaling partner proteins to alter gene expression at both transcriptional and posttranslational levels and consequently the metabolic and developmental programs of plants.



Cryptochromes are widely distributed in bacteria and eukaryotes but are not found in archaea, although archaea do have a CPD photolyase. Cryptochromes have now been found in various animal lineages, including insects, fish, amphibians, and mammals. Animal cryptochromes act as components of the circadian clock that control daily physiological and behavioral rhythms and as photoreceptors that mediate entrainment of the circadian clock to light.

<http://www.ks.uiuc.edu/Research/cryptochrome/>

<https://genomebiology.biomedcentral.com/articles/10.1186/gb-2005-6-5-220>

Newton 's Law of Cooling by Prof. Subhashish Chattopadhyay SKMClasses Bangalore Useful for IIT-JEE, CBSE, I.Sc. PU-II, Boards, CET, CEE, PET, IGCSE IB AP-Physics and other exams

About Spintronics

Spintronics (a portmanteau meaning spin transport electronics), also known as spinelectronics or fluxtronics, is the study of the intrinsic spin of the electron and its associated magnetic moment, in addition to its fundamental electronic charge, in solid-state devices.

Spintronics differs from the older magnetoelectronics, in that spins are manipulated by both magnetic and electrical fields.

Spintronics emerged from discoveries in the 1980s concerning spin-dependent electron transport phenomena in solid-state devices. This includes the observation of spin-polarized electron injection from a ferromagnetic metal to a normal metal by Johnson and Silsbee (1985) and the discovery of giant magnetoresistance independently by Albert Fert et al. and Peter Grünberg et al. (1988). The origins of spintronics can be traced to the ferromagnet/superconductor tunneling experiments pioneered by Meservey and Tedrow and initial experiments on magnetic tunnel junctions by Julliere in the 1970s. The use of semiconductors for spintronics began with the theoretical proposal of a spin field-effect-transistor by Datta and Das in 1990 and of the electric dipole spin resonance by Rashba in 1960.

Conventional electronic devices rely on the transport of electrical charge carriers - electrons - in a semiconductor such as silicon. Now, however, physicists are trying to exploit the 'spin' of the electron rather than its charge to create a remarkable new generation of 'spintronic' devices which will be smaller, more versatile and more robust than those currently making up silicon chips and circuit elements. The potential market is worth hundreds of billions of dollars a year.

All spintronic devices act according to the simple scheme: (1) information is stored (written) into spins as a particular spin orientation (up or down), (2) the spins, being attached to mobile electrons, carry the information along a wire, and (3) the information is read at a terminal. Spin orientation of conduction electrons survives for a relatively long time (nanoseconds, compared to tens of femtoseconds during which electron momentum decays), which makes spintronic devices particularly attractive for memory storage and magnetic sensors applications, and, potentially for quantum computing where electron spin would represent a bit (called qubit) of information.

<http://phys.org/news/2015-09-shift-electronics-spintronics-possibilities-faster.html>

<http://www.spintronicbbsr.org/>

About Excitons

Exciton, the combination of an electron and a positive hole (an empty electron state in a valence band), which is free to move through a nonmetallic crystal as a unit. An exciton is a bound state of an electron and an electron hole which are attracted to each other by the electrostatic Coulomb force. It is an electrically neutral quasiparticle that exists in insulators, semiconductors and in some liquids. The exciton is regarded as an elementary excitation of condensed matter that can transport energy without transporting net electric charge.

Because the electron and the positive hole have equal but opposite electrical charges, the exciton as a whole has no net electrical charge (though it transports energy). This makes excitons difficult to detect, but detection is possible by indirect means.

Also read about polaron, magnon, phonon

When an electron in an exciton recombines with a positive hole, the original atom is restored, and the exciton vanishes. The energy of the exciton may be converted into light when this happens, or it may be transferred to an electron of a neighbouring atom in the solid. If the energy is transferred to a neighbouring electron, a new exciton is produced as this electron is forced away from its atom.

An exciton can form when a photon is absorbed by a semiconductor. This excites an electron from the valence band into the conduction band. In turn, this leaves behind a positively charged electron hole (an abstraction for the location from which an electron was moved). The electron in the conduction band is then effectively attracted to this localized hole by the repulsive Coulomb forces from large numbers of electrons surrounding the hole and excited electron. This attraction provides a stabilizing energy balance. Consequently, the exciton has slightly less energy than the unbound electron and hole. The wave-function of the bound state is said to be hydrogenic, an exotic atom state akin to that of a hydrogen atom. However, the binding energy is much smaller and the particle's size much larger than a hydrogen atom. This is because of both the screening of the Coulomb force by other electrons in the semiconductor (i.e., its dielectric constant), and the small effective masses of the excited electron and hole. The recombination of the electron and hole, i.e. the decay of the exciton, is limited by resonance stabilization due to the overlap of the electron and hole wave functions, resulting in an extended lifetime for the exciton.

The electron and hole may have either parallel or anti-parallel spins. The spins are coupled by the exchange interaction, giving rise to exciton fine structure. In periodic lattices, the properties of an exciton show momentum (k -vector) dependence.

The concept of excitons was first proposed by Yakov Frenkel in 1931, when he described the excitation of atoms in a lattice of insulators. He proposed that this excited state would be able to travel in a particle-like fashion through the lattice without the net transfer of charge.

About Bohr Magneton

The Bohr Magneton is the magnitude of the magnetic dipole moment of an orbiting electron with an orbital angular momentum of \hbar . According to the Bohr model, this is the ground state, i.e. the state of lowest possible energy. In the summer of 1913, this value was naturally obtained by the Danish physicist Niels Bohr as a consequence of his atom model. In 1920, Wolfgang Pauli gave the Bohr magneton its name in an article where he contrasted it with the Magneton of the experimentalists which he called the Weiss Magneton.

The idea of elementary magnets is due to Walther Ritz (1907) and Pierre Weiss. Already before the Rutherford model of atomic structure, several theorists commented that the magneton should involve Planck's constant h . By postulating that the ratio of electron kinetic energy to orbital frequency should be equal to h , Richard Gans computed a value that was twice as large as the Bohr Magneton in September 1911. At the First Solvay Conference in November that year, Paul Langevin obtained a submultiple. The Romanian physicist Ștefan Procopiu had obtained the expression for the magnetic moment of the electron in 1911. The value is sometimes referred to as the "Bohr-Procopiu magneton" in Romanian scientific literature.

-

About Enrico Fermi (1938 Nobel Prize in Physics)



Enrico Fermi was born in Rome on 29th September, 1901, the son of Alberto Fermi, a Chief Inspector of the Ministry of Communications, and Ida de Gattis. He attended a local grammar school, and his early aptitude for mathematics and physics was recognized and encouraged by his father's colleagues, among them A. Amidei. In 1918, he won a fellowship of the Scuola Normale Superiore of Pisa. He spent four years at the University of Pisa, gaining his doctor's degree in physics in 1922, with Professor Puccianti. **He was an Atheist.**

Soon afterwards, in 1923, he was awarded a scholarship from the Italian Government and spent some months with Professor Max Born in Göttingen. With a Rockefeller Fellowship, in 1924, he moved to Leyden to work with P. Ehrenfest, and later that same year he returned to Italy to occupy for two years (1924-1926) the post of Lecturer in Mathematical Physics and Mechanics at the University of Florence.

In 1926, Fermi discovered the statistical laws, nowadays known as the «Fermi statistics», governing the particles subject to Pauli's exclusion principle (now referred to as «fermions», in contrast with «bosons» which obey the Bose-Einstein statistics).

Newton 's Law of Cooling by Prof. Subhashish Chattopadhyay SKMClasses Bangalore Useful for IIT-JEE, CBSE, I.Sc. PU-II, Boards, CET, CEE, PET, IGCSE IB AP-Physics and other exams

In 1927, Fermi was elected Professor of Theoretical Physics at the University of Rome (a post which he retained until 1938, when he - immediately after the receipt of the Nobel Prize - emigrated to America, primarily to escape Mussolini's fascist dictatorship).

During the early years of his career in Rome he occupied himself with electrodynamic problems and with theoretical investigations on various spectroscopic phenomena. But a capital turning-point came when he directed his attention from the outer electrons towards the atomic nucleus itself. In 1934, he evolved the β -decay theory, coalescing previous work on radiation theory with Pauli's idea of the neutrino. Following the discovery by Curie and Joliot of artificial radioactivity (1934), he demonstrated that nuclear transformation occurs in almost every element subjected to neutron bombardment. This work resulted in the discovery of slow neutrons that same year, leading to the discovery of nuclear fission and the production of elements lying beyond what was until then the Periodic Table.

In 1938, Fermi was without doubt the greatest expert on neutrons, and he continued his work on this topic on his arrival in the United States, where he was soon appointed Professor of Physics at Columbia University, N.Y. (1939-1942).

Upon the discovery of fission, by Hahn and Strassmann early in 1939, he immediately saw the possibility of emission of secondary neutrons and of a chain reaction. He proceeded to work with tremendous enthusiasm, and directed a classical series of experiments which ultimately led to the atomic pile and the first controlled nuclear chain reaction. This took place in Chicago on December 2, 1942 - on a squash court situated beneath Chicago's stadium. He subsequently played an important part in solving the problems connected with the development of the first atomic bomb (He was one of the leaders of the team of physicists on the Manhattan Project for the development of nuclear energy and the atomic bomb.)

In 1944, Fermi became an American citizen, and at the end of the war (1946) he accepted a professorship at the Institute for Nuclear Studies of the University of Chicago, a position which he held until his untimely death in 1954. There he turned his attention to high-energy physics, and led investigations into the pion-nucleon interaction.

During the last years of his life Fermi occupied himself with the problem of the mysterious origin of cosmic rays, thereby developing a theory, according to which a universal magnetic field - acting as a giant accelerator - would account for the fantastic energies present in the cosmic ray particles.

Professor Fermi was the author of numerous papers both in theoretical and experimental physics. His most important contributions were:

"Sulla quantizzazione del gas perfetto monoatomico", Rend. Accad. Naz. Lincei, 1935 (also in Z. Phys., 1936), concerning the foundations of the statistics of the electronic gas and of the gases made of particles that obey the Pauli Principle.

Several papers published in Rend. Accad. Naz. Lincei, 1927-28, deal with the statistical model of the atom (Thomas-Fermi atom model) and give a semiquantitative method for the

Newton 's Law of Cooling by Prof. Subhashish Chattopadhyay SKMClasses Bangalore Useful for IIT-JEE, CBSE, I.Sc. PU-II, Boards, CET, CEE, PET, IGCSE IB AP-Physics and other exams

Newton 's Law of Cooling by Prof. Subhashish Chattopadhyay SKMClasses Bangalore Useful for IIT-JEE, CBSE, I.Sc. PU-II, Boards, CET, CEE, PET, IGCSE IB AP-Physics and other exams

calculation of atomic properties. A resumé of this work was published by Fermi in the volume: *Quantentheorie und Chemie*, edited by H. Falkenhagen, Leipzig, 1928.

"Über die magnetischen Momente der Atomkerne", *Z. Phys.*, 1930, is a quantitative theory of the hyperfine structures of spectrum lines. The magnetic moments of some nuclei are deduced therefrom.

"Tentativo di una teoria dei raggi β ", *Ricerca Scientifica*, 1933 (also *Z. Phys.*, 1934) proposes a theory of the emission of β -rays, based on the hypothesis, first proposed by Pauli, of the existence of the neutrino.

The Nobel Prize for Physics was awarded to Fermi for his work on the artificial radioactivity produced by neutrons, and for nuclear reactions brought about by slow neutrons. The first paper on this subject "Radioattività indotta dal bombardamento di neutroni" was published by him in *Ricerca Scientifica*, 1934. All the work is collected in the following papers by himself and various collaborators: "Artificial radioactivity produced by neutron bombardment", *Proc. Roy. Soc.*, 1934 and 1935; "On the absorption and diffusion of slow neutrons", *Phys. Rev.*, 1936. The theoretical problems connected with the neutron are discussed by Fermi in the paper "Sul moto dei neutroni lenti", *Ricerca Scientifica*, 1936.

His Collected Papers are being published by a Committee under the Chairmanship of his friend and former pupil, Professor E. Segrè (Nobel Prize winner 1959, with O. Chamberlain, for the discovery of the antiproton).

Fermi was member of several academies and learned societies in Italy and abroad (he was early in his career, in 1929, chosen among the first 30 members of the Royal Academy of Italy).

As lecturer he was always in great demand (he has also given several courses at the University of Michigan, Ann Arbor; and Stanford University, Calif.). He was the first recipient of a special award of \$50,000 - which now bears his name - for work on the atom.

Professor Fermi married Laura Capon in 1928. They had one son Giulio and one daughter Nella. His favourite pastimes were walking, mountaineering, and winter sports.

He died in Chicago on 28th November, 1954.

-

Newton 's Law of Cooling by Prof. Subhashish Chattopadhyay SKMClasses Bangalore Useful for IIT-JEE, CBSE, I.Sc. PU-II, Boards, CET, CEE, PET, IGCSE IB AP-Physics and other exams

About Paul Dirac (1933 Nobel Prize in Physics)

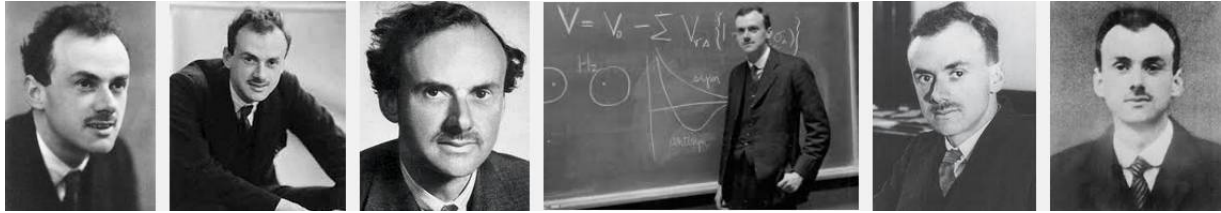

Paul Adrien Maurice Dirac was born on 8th August, 1902, at Bristol, England, his father being Swiss and his mother English. He was educated at the Merchant Venturer's Secondary School, Bristol, then went on to Bristol University. Here, he studied electrical engineering, obtaining the B.Sc. (Engineering) degree in 1921. He then studied mathematics for two years at Bristol University, later going on to St. John's College, Cambridge, as a research student in mathematics. He received his Ph.D. degree in 1926. The following year he became a Fellow of St. John's College and, in 1932, Lucasian Professor of Mathematics at Cambridge.

Paul Dirac was an Atheist.

Dirac's work has been concerned with the mathematical and theoretical aspects of quantum mechanics. He began work on the new quantum mechanics as soon as it was introduced by Heisenberg in 1925 - independently producing a mathematical equivalent which consisted essentially of a noncommutative algebra for calculating atomic properties - and wrote a series of papers on the subject, published mainly in the Proceedings of the Royal Society, leading up to his relativistic theory of the electron (1928) and the theory of holes (1930). This latter theory required the existence of a positive particle having the same mass and charge as the known (negative) electron. This, the positron was discovered experimentally at a later date (1932) by C. D. Anderson, while its existence was likewise proved by Blackett and Occhialini (1933) in the phenomena of "pair production" and "annihilation".

The importance of Dirac's work lies essentially in his famous wave equation, which introduced special relativity into Schrödinger's equation. Taking into account the fact that, mathematically speaking, relativity theory and quantum theory are not only distinct from each other, but also oppose each other, Dirac's work could be considered a fruitful reconciliation between the two theories.

Dirac's publications include the books Quantum Theory of the Electron (1928) and The Principles of Quantum Mechanics (1930; 3rd ed. 1947).

He was elected a Fellow of the Royal Society in 1930, being awarded the Society's Royal Medal and the Copley Medal. He was elected a member of the Pontifical Academy of Sciences in 1961.

Dirac has travelled extensively and studied at various foreign universities, including Copenhagen, Göttingen, Leyden, Wisconsin, Michigan, and Princeton (in 1934, as Visiting Professor). In 1929, after having spent five months in America, he went round the world, visiting Japan together with Heisenberg, and then returned across Siberia.

Newton 's Law of Cooling by Prof. Subhashish Chattopadhyay SKMClasses Bangalore Useful for IIT-JEE, CBSE, I.Sc. PU-II, Boards, CET, CEE, PET, IGCSE IB AP-Physics and other exams

In 1937 he married Margit Wigner, of Budapest.

-

http://www.celebatheists.com/wiki/Main_Page gives names of Hundreds of Atheists.

[Douglas Adams](#), [Ayaan Hirsi Ali](#), [Woody Allen](#), [Fred Armisen](#), [Lance Armstrong](#), [Darren Aronofsky](#), [Isaac Asimov](#), [Julian Assange](#), [Dan Barker](#), [Dave Barry](#), [Ingmar Bergman](#), [Pierre Berton](#), [Niels Bohr](#), [Richard Branson](#), [Derren Brown](#), [Kari Byron](#), [James Cameron](#), [Asia Carrera](#), [George Carlin](#), [John Carmack](#), [Adam Carolla](#), [John Carpenter](#), [Asia Carrera](#), [Fidel Castro](#), [Noam Chomsky](#), [Jeremy Clarkson](#), [Billy Connolly](#), [Francis Crick](#), [David Cronenberg](#), [David Cross](#), [Alan Cumming](#), [Rodney Dangerfield](#), [Richard Dawkins](#), [Daniel Dennett](#), [Ani DiFranco](#), [Micky Dolenz](#), [Albert Einstein](#), [Harlan Ellison](#), [Paul Erdős](#), [Richard Feynman](#), [Harvey Fierstein](#), [Reginald Finley](#), [Barney Frank](#), [Morgan Freeman](#), [Larry Flynt](#), [Dave Foley](#), [Arian Foster](#), [Jodie Foster](#), [Janeane Garofalo](#), [Bill Gates](#), [Bob Geldof](#), [Ricky Gervais](#), [Ira Glass](#), [James Gleick](#), [Robert Heinlein](#), [Ernest Hemingway](#), [Katharine Hepburn](#), [Christopher Hitchens](#), [Jamie Hyneman](#), [Eddie Izzard](#), [Penn Jillette](#), [Billy Joel](#), [Ana Kasparian](#), [Diane Keaton](#), [Skandar Keynes](#), [Michael Kinsley](#), [Keira Knightley](#), [Kramer](#), [John Landis](#), [Hugh Laurie](#), [Artie Lange](#), [Richard Leakey](#), [Bruce Lee](#), [Tom Lehrer](#), [John Lennon](#), [Tom Leykis](#), [James Lipton](#), [H.P. Lovecraft](#), [Ernst Mach](#), [Seth MacFarlane](#), [Bill Maher](#), [John Malkovich](#), [Barry Manilow](#), [Todd McFarlane](#), [Sir Ian McKellen](#), [Arthur Miller](#), [Frank Miller](#), [Claude Monet](#), [Julianne Moore](#), [Rafael Nadal](#), [Randy Newman](#), [Mike Nichols](#), [Jack Nicholson](#), [Gary Numan](#), [Bob Odenkirk](#), [Patton Oswalt](#), [Camille Paglia](#), [Trey Parker](#), [PewDiePie](#), [Steven Pinker](#), [Brad Pitt](#), [Joaquin Phoenix](#), [Paula Poundstone](#), [Terry Pratchett](#), [Robin Quivers](#), [Daniel Radcliffe](#), [James Randi](#), [Ron Reagan Jr.](#), [Rob Reiner](#), [Keanu Reeves](#), [Rick Reynolds](#), [Gene Roddenberry](#), [Henry Rollins](#), [Andy Rooney](#), [Salman Rushdie](#), [Adam Savage](#), [Brian Sapient](#), [Erwin Schrödinger](#), [Bob Simon](#), [Steven Soderbergh](#), [Annika Sorenstam](#), [George Soros](#), [Richard Stallman](#), [Howard Stern](#), [Matt Stone](#), [Julia Sweeney](#), [Teller](#), [Studs Terkel](#), [Pat Tillman](#), [Tool](#), [Alan Turing](#), [Eddie Vedder](#), [Jesse Ventura](#), [Gore Vidal](#), [Vincent van Gogh](#), [Kurt Vonnegut Jr.](#), [Steven Weinberg](#), [Joss Whedon](#), [Ted Williams](#), [Steve Wozniak](#), HUNDREDS MORE...

Newton 's Law of Cooling by Prof. Subhashish Chattopadhyay SKMClasses Bangalore Useful for IIT-JEE, CBSE, I.Sc. PU-II, Boards, CET, CEE, PET, IGCSE IB AP-Physics and other exams

Newton 's Law of Cooling by Prof. Subhashish Chattopadhyay SKMClasses Bangalore Useful for IIT-JEE, CBSE, I.Sc. PU-II, Boards, CET, CEE, PET, IGCSE IB AP-Physics and other exams

About Coriolis Force or Coriolis Effect

An effect whereby a mass moving in a rotating system experiences a force (the Coriolis force) acting perpendicular to the direction of motion and to the axis of rotation. On the earth, the effect tends to deflect moving objects to the right in the northern hemisphere and to the left in the southern and is important in the formation of cyclonic weather systems.

Gaspard-Gustave de Coriolis was a French mathematician, mechanical engineer and scientist. He is best known for his work on the supplementary forces that are detected in a rotating frame of reference, leading to the Coriolis effect. He was the first to coin the term "work" for the transfer of energy by a force acting through a distance.

[http://ww2010.atmos.uiuc.edu/\(Gh\)/guides/mtr/fw/crls.rxml](http://ww2010.atmos.uiuc.edu/(Gh)/guides/mtr/fw/crls.rxml)

https://en.wikipedia.org/wiki/Coriolis_force

<https://www.youtube.com/watch?v=aeY9tY9vKgs>

<http://geography.about.com/od/physicalgeography/a/coriolis.htm>

https://www.youtube.com/watch?v=_sayCU1TNyg

<https://www.youtube.com/watch?v=i2mec3vgeal>

<http://www.universetoday.com/73828/what-is-the-coriolis-effect/>

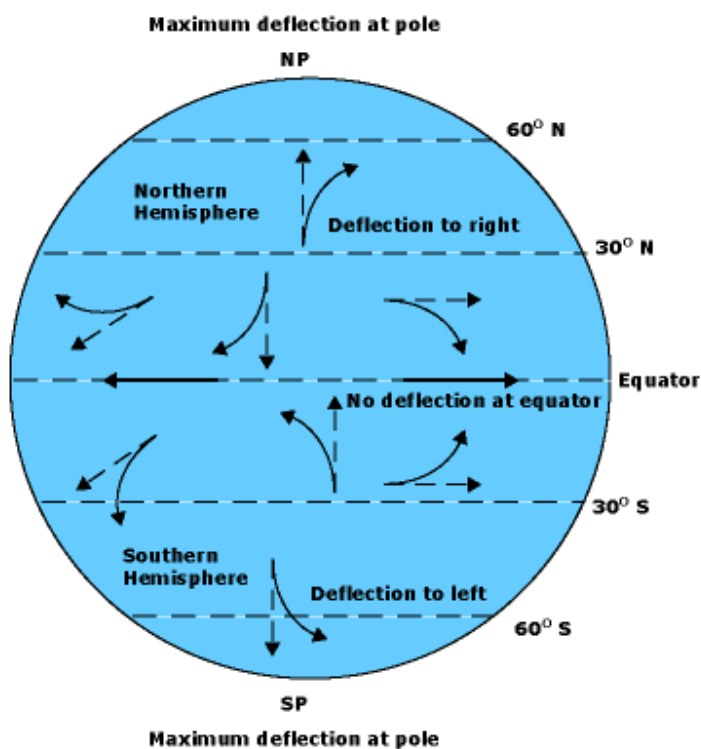

Newton 's Law of Cooling by Prof. Subhashish Chattopadhyay SKMClasses Bangalore Useful for IIT-JEE, CBSE, I.Sc. PU-II, Boards, CET, CEE, PET, IGCSE IB AP-Physics and other exams

Newton 's Law of Cooling by Prof. Subhashish Chattopadhyay SKMClasses Bangalore Useful for IIT-JEE, CBSE, I.Sc. PU-II, Boards, CET, CEE, PET, IGCSE IB AP-Physics and other exams

About Parapsychology by Dr Dean Radin

Dean Radin is a researcher and author in the field of parapsychology.

He has been Senior Scientist at the Institute of Noetic Sciences (IONS), in Petaluma, California, USA, since 2001, served on dissertation committees at Saybrook Graduate School and Research Center, and former President of the Parapsychological Association. He is also co-editor-in-chief of the journal Explore: The Journal of Science and Healing.

Radin's ideas and work have been criticized by scientists and philosophers skeptical of paranormal claims.

Parapsychology is a field of study concerned with the investigation of paranormal and psychic phenomena which include telepathy, precognition, clairvoyance, psychokinesis, near-death experiences, reincarnation, apparitional experiences, and other paranormal claims. It is often identified as pseudoscience.

Parapsychology research is largely conducted by private institutions in several countries and funded through private donations, and the subject rarely appears in mainstream science journals. Most papers about parapsychology are published in a small number of niche journals. Parapsychology has been criticised for continuing investigation despite being unable to provide convincing evidence for the existence of any psychic phenomena after more than a century of research.

It has been noted that most academics do not take the claims of parapsychology seriously.

Para is from Greek, and means "beside, closely related to, beyond..." The term parapsychology was coined in or around 1889 by philosopher Max Dessoir. It was adopted by J. B. Rhine in the 1930s as a replacement for the term psychical research in order to indicate a significant shift toward experimental methodology and academic discipline. The term originates from the Greek: παρά para meaning "alongside", and psychology.

In parapsychology, psi is the unknown factor in extrasensory perception and psychokinesis experiences that is not explained by known physical or biological mechanisms. The term is derived from the Greek ψ psi, 23rd letter of the Greek alphabet and the initial letter of the Greek ψυχή psyche, "mind, soul". The term was coined by biologist Berthold P. Wiesner, and first used by psychologist Robert Thouless in a 1942 article published in the British Journal of Psychology.

The Parapsychological Association divides psi into two main categories: psi-gamma for extrasensory perception and psi-kappa for psychokinesis. In popular culture, "psi" has become more and more synonymous with special psychic, mental, and "psionic" abilities and powers.

https://www.youtube.com/watch?v=qw_O9Qiwqew

<https://en.wikipedia.org/wiki/Parapsychology>

Newton 's Law of Cooling by Prof. Subhashish Chattopadhyay SKMClasses Bangalore Useful for IIT-JEE, CBSE, I.Sc. PU-II, Boards, CET, CEE, PET, IGCSE IB AP-Physics and other exams

Newton 's Law of Cooling by Prof. Subhashish Chattopadhyay SKMClasses Bangalore Useful for IIT-JEE, CBSE, I.Sc. PU-II, Boards, CET, CEE, PET, IGCSE IB AP-Physics and other exams

https://www.youtube.com/watch?v=fSP_YPv6qS0

<https://www.youtube.com/watch?v=VgEmZ2xwZec>

<https://www.youtube.com/watch?v=ObGSGXzt328>

<https://www.youtube.com/watch?v=m5w42aZH9cc&list=PL2A74rJwZavVhwIk9ZH9BAWFgm-m1rSVu>

<https://www.youtube.com/watch?v=KqwphfRD0o8>

https://www.youtube.com/watch?v=fSP_YPv6qS0&list=PL2A74rJwZavX_6bPdAzrykMutjElzgsWG

<http://www.deanradin.com/>



Most important <https://www.youtube.com/watch?v=W5KNNR-yPMM>

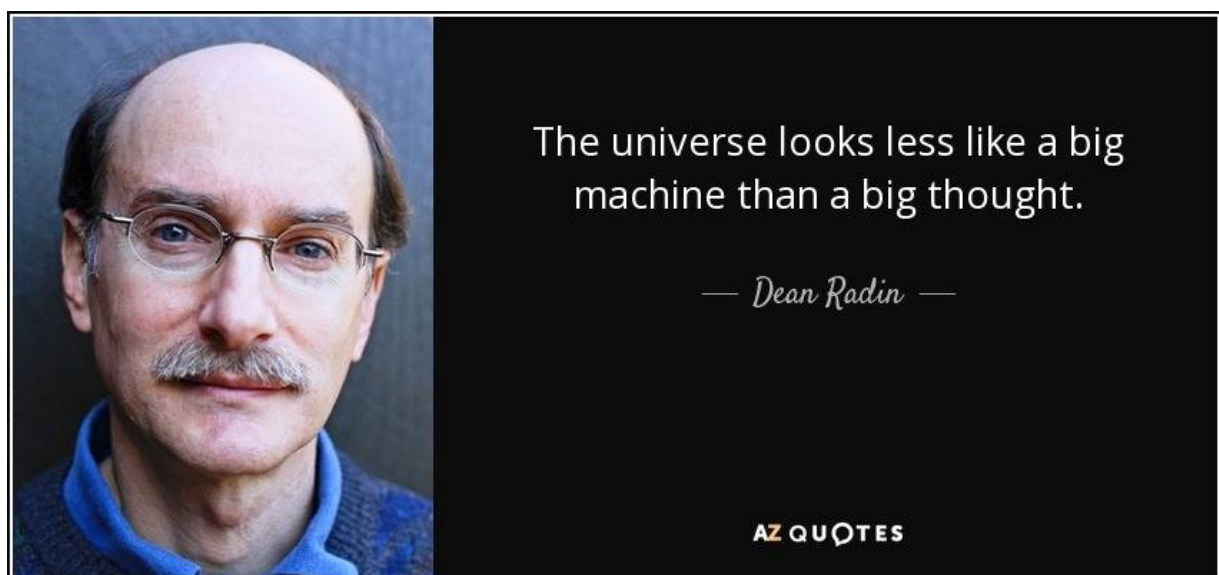

Newton 's Law of Cooling by Prof. Subhashish Chattopadhyay SKMClasses Bangalore Useful for IIT-JEE, CBSE, I.Sc. PU-II, Boards, CET, CEE, PET, IGCSE IB AP-Physics and other exams

Newton 's Law of Cooling by Prof. Subhashish Chattopadhyay SKMClasses Bangalore Useful for IIT-JEE, CBSE, I.Sc. PU-II, Boards, CET, CEE, PET, IGCSE IB AP-Physics and other exams

About Parity Violation - Space is not Perfectly Symmetric - Yang Lee (Nobel Physics 1957)

Chinese Physicists Yang and Lee; received Nobel Prize for one of the quickest; the gap between Theoretical Prediction to Experimental confirmation being shortest.

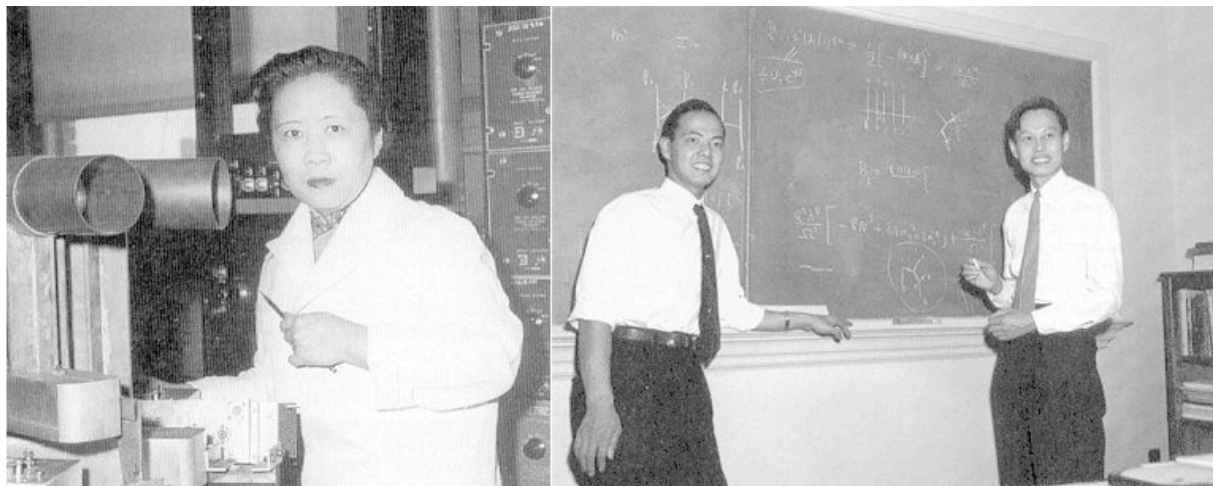

C. S. Wu

T. D. Lee

C. N. Yang

Yang and Lee Predicted broken Symmetry. Experimental proof by Chien Shiung Wu et al. came within 2 years. Asymmetry is used by charges and dipoles for extracting and pouring out Electromagnetic energy from the vacuum, yet not one current Electrical Engineering or classical electromagnetics textbook mentions the energy implications of dipolar asymmetry. Nor do they mention that every charge and dipole freely pours out real observable EM energy continuously, with no observable energy input.

In 1943 Tsung Dao Lee was a student in the Kweichow province of China. It was the time of the Sino-Japanese War, and the Japanese invasion of the mainland forced Lee to move to Kunming. There he attended the National Southwest University where he met Chen Ning Yang. Lee and Yang had only a nodding acquaintance then. In 1946 both students received fellowships to study in the United States. Yang had pursued Enrico Fermi from Columbia to the University of Chicago - he was to have a close association with Fermi. Lee, on the other hand, had little choice. Only one school in the U.S. then allowed an undergraduate to work towards the PhD without the intermediate degrees, the University of Chicago. The two graduate students fast became friends.

For a while Yang had tried experimental physics, but it was not to be. Other graduate students had teased him, "Where there was a bang, there was Yang". Yang eventually did his doctoral thesis under the supervision of Edward Teller. Lee on the other hand knew he was a theorist from the start. He did his doctoral thesis under Fermi. Yang recalls Fermi's advice on his career: As a young man, work on practical problems; do not worry about things of fundamental importance. For all of his admiration of Fermi, Yang chose to ignore this bit of advice. Both Lee and Yang graduated and for awhile worked as staff members at the Institute for Advanced Study in Princeton. Lee had become a reputable theoretical physicist, invoking

Newton 's Law of Cooling by Prof. Subhashish Chattopadhyay SKMClasses Bangalore Useful for IIT-JEE, CBSE, I.Sc. PU-II, Boards, CET, CEE, PET, IGCSE IB AP-Physics and other exams

Newton 's Law of Cooling by Prof. Subhashish Chattopadhyay SKMClasses Bangalore Useful for IIT-JEE, CBSE, I.Sc. PU-II, Boards, CET, CEE, PET, IGCSE IB AP-Physics and other exams

praise from J. Robert Oppenheimer as "one of the most brilliant theoretical physicists then known". Thus the individual physicists T. D. Lee and C. N. Yang had established their reputations by 1956, when their work together would help clear a mystery known as the theta-tau puzzle and topple of the most fundamental conservation laws.

The Theta-Tau Puzzle

Within the cosmic rays in which C. F. Powell had discovered the pi meson (pion) were other new particles. In 1949 Powell identified a cosmic ray particle which disintegrated into three pions. He dubbed this new particle the tau meson. Another particle called the theta meson was also discovered. It disintegrated into two pions. Both particles disintegrated via the weak force. Now, a problem arose when the masses and the lifetimes of the tau and theta particles were considered. The two particles turned out to be indistinguishable other than their mode of decay. Their masses and lifetimes were identical, within the experimental uncertainties. Were they in fact the same particle? The problem itself was not that the tau and theta, if indeed they were the same particle, decayed in two different modes, one by two pions, the other by three pions. The problem dealt with the more fundamental parity conservation law. In 1953 the physicist R. H. Dalitz argued that since the pion has parity of -1 , two pions would combine to produce a net parity of $(-1)(-1) = +1$, and three pions would combine to have total parity of $(-1)(-1)(-1) = -1$. Hence, if conservation of parity holds, the theta should have parity of $+1$, and the tau of -1 . Hence, they could not be the same particle. Thus was born the theta-tau puzzle. Its resolution would involve an almost unacceptable proposition to the physicists of the time.

The Beginnings of Doubt

The events which led to the publication of Lee and Yang's historic paper, Question of Parity Conservation in Weak Interactions, began at the International Conference on High Energy Physics at the University of Rochester in April 1956. Lee and Yang attended the conference with a proposal for ending the theta-tau puzzle. Their idea was that certain kinds of elementary particles occur in two forms with different parities. The idea was called parity doubling. Also attending the conference was the theoretical physicist Richard Feynman, who is renowned for his development of the field of physics called quantum electrodynamics. Feynman's roommate at the conference was the experimentalist Martin Block. Block suggested to Feynman on the first night of the conference that parity just may not be conserved in certain interactions. The next day, following Yang's presentation of the parity doubling idea, Feynman brought up the question of non-conservation of parity. Feynman himself later said, "I thought the idea (of parity violation) unlikely, but possible, and a very exciting possibility." Indeed Feynman later made a fifty dollar bet with a friend that parity would not be violated. Yang's reply was that he and Lee had considered the idea but had arrived at no conclusions. During the discussion, Wigner, who had formulated the law of conservation of parity in the first place, also suggested that perhaps it did not hold in weak interactions.

Lee and Yang pursued the question further after the conference. "Early in May, when they were sitting in the White Rose Cafe near the corner of Broadway and 125th Street, in the

Newton 's Law of Cooling by Prof. Subhashish Chattopadhyay SKMClasses Bangalore Useful for IIT-JEE, CBSE, I.Sc. PU-II, Boards, CET, CEE, PET, IGCSE IB AP-Physics and other exams

Newton 's Law of Cooling by Prof. Subhashish Chattopadhyay SKMClasses Bangalore Useful for IIT-JEE, CBSE, I.Sc. PU-II, Boards, CET, CEE, PET, IGCSE IB AP-Physics and other exams

vicinity of Columbia University, it suddenly struck them that it might be profitable to make a careful study of all known experiments involving weak interactions". After several weeks of reviewing past experiments, they had come to two conclusions:

"Past experiments on the weak interactions had actually no bearing on the question of parity conservation."

"In strong interactions, ... there were indeed many experiments that established parity conservation to a high degree of accuracy..."

As Yang commented in his Nobel lecture, "The fact that parity conservation in the weak interactions was believed for so long without experimental support was very startling. But what was more startling was the prospect that a space-time symmetry law which the physicists have learned so well may be violated. This prospect did not appeal to use."

The Proposed Experiment

When Lee and Yang's paper appeared in the October 1, 1956 issue of The Physical Review, physicists were not immediately prompted into action. The proposition of parity nonconservation was not unequivocally denied; rather, the possibility appeared so unlikely that experimental proof did not warrant immediate attention. The physicist Freeman Dyson wrote of his reaction to the paper: "A copy of it was sent to me and I read it. I read it twice. I said, 'This is very interesting,' or words to that effect. But I had not the imagination to say, 'By golly, if this is true it opens up a whole new branch of physics.' And I think other physicists, with very few exceptions, at that time were as unimaginative as I." Hence, the initial reaction among most physicists to verifying parity conservation was not enthusiastic.

In their paper, Lee and Yang stated, "To decide unequivocally whether parity is conserved in weak interactions, one must perform an experiment to determine whether weak interactions differentiate the right from the left." And they proposed several experiments. One of the simplest experiments (conceptually) involved measurements on the beta decay of cobalt-60. The idea involved orienting cobalt nuclei with a strong magnetic field so that their spins are aligned in the same direction. Beta rays (electrons) are emitted at the poles of the nuclei. A mirror image of the system would also show beta rays being emitted from the poles of the mirror cobalt nuclei, the only difference being that the north and south poles of the mirror nuclei would be reversed since they spin in opposite direction of their real counterparts. Hence parity conservation demands that the emitted beta rays be equally distributed between the two poles. If more beta particles emerged from one pole than the other, it would be possible to distinguish the mirror image nuclei from their counterparts. Thus an anisotropy in the emitted beta rays would be tantamount to parity violation.

Madame Chien Shiung Wu

Another immigrant was now to play the next major role, Madame Chien-Shiung Wu. Arriving at Berkeley in 1936 from Shanghai, Wu was one of the most ardently pursued coeds on campus. But she was also a hard worker who abhorred the marked absence of women from the

Newton 's Law of Cooling by Prof. Subhashish Chattopadhyay SKMClasses Bangalore Useful for IIT-JEE, CBSE, I.Sc. PU-II, Boards, CET, CEE, PET, IGCSE IB AP-Physics and other exams

American scientific establishment. She says, " ... it is shameful that there are so few women in science... In China there are many, many women in physics. There is a misconception in America that women scientists are all dowdy spinsters. This is the fault of men. In Chinese society, a woman is valued for what she is, and men encourage her to accomplishments --- yet she retains eternally feminine.". In this view, there is a clear distinction between American and Chinese cultures. Yang, too, had to come to terms with the differences between the two cultures. In his Nobel address, he says, "I am heavy with awareness of the fact that I am in more than one sense a product of both the Chinese and Western cultures, in harmony and in conflict... I am as proud of my Chinese heritage and background as I am devoted to modern science, a part of human civilization of Western origin...". Returning to Madame Wu, the physicist Emile Segre', one of her teachers, said of her, "She is a slave driver. She is the image of the militant woman so well known in Chinese literature as either empress or mother." But by 1956 she had a world-wide reputation for her work on beta decay. Beta decay involves the weak interaction. Wu's experiments were highly regarded for their simplicity and elegance. At the time Lee and Yang considered the question of parity, Wu was a professor at Columbia and a long time friend of both men. She was the first to act on the proposed experiment involving beta decay in cobalt 60.

Even before Lee and Yang's paper had been submitted to The Physical Review, Lee had discussed the experiment with Wu. At the time, Wu and her husband had planned a trip to Europe and the Far East. But she chose instead to remain and perform the experiment rather than lose the opportunity to other physicists who might recognize its importance. However, the experiment could not be performed with only her expertise. Reaching the low temperatures necessary to be able to orient the cobalt nuclei spins required equipment few laboratories possessed. Nevertheless, one such laboratory existed in the United States --- the Cryogenics Physics Laboratory at the National Bureau of Standards in Washington. Early in June of 1956, Wu sought the help of Ernest Ambler at NBS. Ambler accepted enthusiastically. Indeed his doctoral thesis dealt with the orientation of cobalt-60 nuclei. In addition, Ralph Hudson, with expertise in cryogenics, and Raymond Hayward and Dale Hoppes, with experience in radiation detection, joined the team. By early October they began to assemble and test their equipment. The same month saw the publication of Lee and Yang's paper.

Lederman, who worked with Columbia's cyclotron, realized that he could perform an independent test of parity with the cyclotron. His experiment, which involved the decay of pi and mu mesons, had also been proposed by Lee and Yang in their paper. Soon, Lederman, along with his graduate students, Marcel Weinrich, and Richard Garwin began their experiments. At the same time, the group under Wu was running into problems. Wanting to verify their results from December 27, they repeated the experiment. Their original finding of a large asymmetry in the beta ray distribution was not consistently reproducible. However, after a week of solving problems with the apparatus, consistent results were obtained. And the results pointed to parity violation. Much consideration was given to the question of the origin of the beta ray asymmetry --- was it really an indication of the failure of parity or some result intrinsic to the experiment? "The group worked around the clock, assembling the apparatus many times, and took their breaks for a few hours sleep when the superfluid helium

Newton 's Law of Cooling by Prof. Subhashish Chattopadhyay SKMClasses Bangalore Useful for IIT-JEE, CBSE, I.Sc. PU-II, Boards, CET, CEE, PET, IGCSE IB AP-Physics and other exams

spoiled their vacuum by finding its way around the stopper at the bottom of the cryostat. Hoppes then slept beside the apparatus, telephoning to the others as soon as its temperature was low enough to begin their experiments again. Finally, on Januray 9th, at 2 o'clock in the morning, Hudson brought out a bottle of Chateau Lafite-Rothschild, 1949, and they drank to the overthrow of the law of parity"

Broken symmetry essentially means that something virtual (shadowy, but real in a special sense and widely used in physics; it has real physical consequences, since it creates all the forces of nature) has become observable (real in the ordinary everyday sense that it can be detected, measured, observed, and used.). The broken symmetry of the end charges of a dipole rigorously means that, once the charges are forcibly separated to form that dipole, the dipole (its end charges) continuously absorbs virtual (fleeting) photons from the seething vacuum, coherently integrates these "photon pieces" into real observable photons, and re-emits the resulting real EM energy in the form of real observable photons in all directions at the speed of light.

That's why a dipolar permanent magnet, with opposite magnetic charges on its ends locked in there by the material itself, continuously exhibits magnetic field in the space surrounding it (out to the ends of the universe, if the magnet has been around long enough). There is a continuous and steady stream of EM energy, extracted directly from the vacuum and integrated into observable magnetic field energy, pouring forth from the dipolarity of that magnet. At any external point in that stream, the steady flow will give a steady or "static" reading for the magnetic field and thus for the intensity of the flow at that point.

Actually there is no such thing as a "static" field or potential in the universe; simply check out Whittaker's 1903 decomposition of the "electrostatic" scalar potential into bidirectional longitudinal EM waves, and his 1904 decomposition of any field and wave pattern into two such potentials comprised of bidirectional longitudinal EM waves. The 1904 paper founded what today is known as superpotential theory.

[https://en.wikipedia.org/wiki/Parity_\(physics\)](https://en.wikipedia.org/wiki/Parity_(physics))

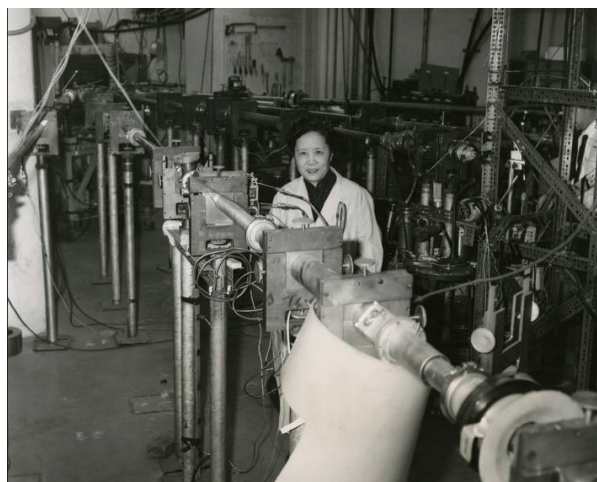

Newton 's Law of Cooling by Prof. Subhashish Chattopadhyay SKMClasses Bangalore Useful for IIT-JEE, CBSE, I.Sc. PU-II, Boards, CET, CEE, PET, IGCSE IB AP-Physics and other exams

About String Theory

I am **least interested** in String theory. The reasons will be soon clear to the reader. Since 1970 s I may have read more than 200 Popular Science articles, on String theory; in various magazines. **What a waste of time!** and **quite foolish act in my part** to read so many. I should have stopped bothering about String theory much earlier if the right information was given in these articles. **The authors / writers often hide or not tell some information, about the string theory; which are its limitations.**

[You may read about String theory as given below, or directly go to the last part / Paragraph **(marked in Red)**]

String theory is a theoretical framework in which the point-like particles of particle physics are replaced by one-dimensional objects called strings. String theory is a mathematical theory of particle physics which models all the subatomic particles in the universe (protons, neutrons, electrons, quarks, photons, etc) as bits of vibrating string. Since last 50 years not a single experiment has verified any of the predictions / explanations of String Theory. Not even got any hint regarding its predictions. So it is a theoretical framework, but with no experimental backup.

Strings and membranes

When the theory was originally developed in the 1970s, the filaments of energy in string theory were considered to be 1-dimensional objects: strings. (One-dimensional indicates that a string has only one dimension, length, as opposed to say a square, which has both length and height dimensions.) These strings came in two forms – closed strings and open strings. An open string has ends that don't touch each other, while a closed string is a loop with no open end. It was eventually found that these early strings, called Type I strings, could go through five basic types of interactions. The interactions are based on a string's ability to have ends join and split apart. Because the ends of open strings can join together to form closed strings, you can't construct a string theory without closed strings. The closed strings have properties that make physicists believe they might describe gravity. Instead of just being a theory of matter particles, physicists began to realize that string theory may just be able to explain gravity and the behavior of particles.

Over the years, it was discovered that the theory required objects other than just strings. These objects can be seen as sheets, or branes. Strings can attach at one or both ends to these branes. Quantum gravity

Modern physics has two basic scientific laws: quantum physics and general relativity. These two scientific laws represent radically different fields of study. Quantum physics studies the very smallest objects in nature, while relativity tends to study nature on the scale of planets, galaxies, and the universe as a whole. (Obviously, gravity affects small particles too, and relativity accounts for this as well.) Theories that attempt to unify the two theories are

Newton 's Law of Cooling by Prof. Subhashish Chattopadhyay SKMClasses Bangalore Useful for IIT-JEE, CBSE, I.Sc. PU-II, Boards, CET, CEE, PET, IGCSE IB AP-Physics and other exams

theories of quantum gravity, and the most promising of all such theories today is string theory.

Unification of forces

Hand-in-hand with the question of quantum gravity, string theory attempts to unify the four forces in the universe – electromagnetic force, the strong nuclear force, the weak nuclear force, and gravity – together into one unified theory. In our universe, these fundamental forces appear as four different phenomena, but string theorists believe that in the early universe (when there were incredibly high energy levels) these forces are all described by strings interacting with each other.

Supersymmetry

All particles in the universe can be divided into two types: bosons and fermions. String theory predicts that a type of connection, called supersymmetry, exists between these two particle types. Under supersymmetry, a fermion must exist for every boson and vice versa. **Unfortunately, experiments have not yet detected these extra particles.**

Supersymmetry is a specific mathematical relationship between certain elements of physics equations. It was discovered outside of string theory, although its incorporation into string theory transformed the theory into supersymmetric string theory (or superstring theory) in the mid-1970s.

Supersymmetry vastly simplifies string theory's equations by allowing certain terms to cancel out. Without supersymmetry, the equations result in physical inconsistencies, such as infinite values and imaginary energy levels.

Because scientists haven't observed the particles predicted by supersymmetry, this is still a theoretical assumption. Many physicists believe that the reason no one has observed the particles is because it takes a lot of energy to generate them. (Energy is related to mass by Einstein's famous $E = mc^2$ equation, so it takes energy to create a particle.) They may have existed in the early universe, but as the universe cooled off and energy spread out after the big bang, these particles would have collapsed into the lower-energy states that we observe today. (We may not think of our current universe as particularly low energy, but compared to the intense heat of the first few moments after the big bang, it certainly is.)

String Theory Lovers, **hope** that astronomical observations or experiments with particle accelerators will uncover some of these higher-energy supersymmetric particles, providing support for this prediction of string theory.

Extra dimensions

Another mathematical result of string theory is that the theory only makes sense in a world with more than three space dimensions! (Our universe has three dimensions of space – left/right, up/down, and front/back.) Two possible explanations currently exist for the location of the extra dimensions:

Newton 's Law of Cooling by Prof. Subhashish Chattopadhyay SKMClasses Bangalore Useful for IIT-JEE, CBSE, I.Sc. PU-II, Boards, CET, CEE, PET, IGCSE IB AP-Physics and other exams

Newton 's Law of Cooling by Prof. Subhashish Chattopadhyay SKMClasses Bangalore Useful for IIT-JEE, CBSE, I.Sc. PU-II, Boards, CET, CEE, PET, IGCSE IB AP-Physics and other exams

The extra space dimensions (generally six of them) are curled up (compactified, in string theory terminology) to incredibly small sizes, so we never perceive them.

We are stuck on a 3-dimensional brane, and the extra dimensions extend off of it and are inaccessible to us.

A major area of research among string theorists is on mathematical models of how these extra dimensions could be related to our own. Some of these recent results have predicted that scientists **may** soon be able to detect these extra dimensions (if they exist) in upcoming experiments, because they may be larger than previously expected.

25 years (or 50 years) and 11 dimensions later, **no luck with experiments**. String theorists have fallen into an elegance trap and that trap is a product of theorists attacking mathematics the way experimentalists attack data. The problem with that is math is not data. The aggressive take-no-prisoners sociology of experimental physics has a natural constraint: results. Hypotheses may be as bold and counter-intuitive as you like because at the end of the week, we'll see what comes out of the accelerator. But when your research is pure math, you have to be more conservative, staying within the bounds of established observation and suggesting experiments to be done before you proceed further. In their quest for the elegant theory of everything, string theorists have broken free of these constraints and in doing so, of science itself. So complete is this break with science, in fact, that prominent string theorists opining that perhaps it is science itself which needs to change to accommodate string theory and that quaint traditions like experiment and result should make room for the notion that every self-consistent mathematical model is in fact a physically real universe and for the anthropic principle, which is a polite term for intelligent design. So much for "elegance".

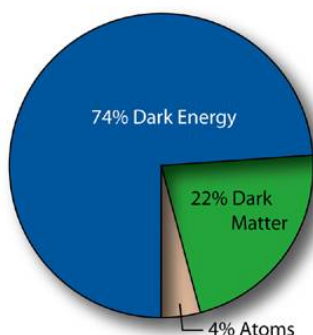

In physical cosmology and astronomy, dark energy is an unknown form of energy which is hypothesized to permeate all of space, tending to accelerate the expansion of the universe. Dark energy is the most accepted hypothesis to explain the observations since the 1990s indicating that **the universe is expanding at an accelerating rate**. Assuming that the standard model of cosmology is correct, the best current measurements indicate that dark energy contributes 68.3% of the total energy in the present-day observable universe. The mass-energy of dark matter and **ordinary (baryonic) matter** contribute 26.8% and **4.9%**,

Newton 's Law of Cooling by Prof. Subhashish Chattopadhyay SKMClasses Bangalore Useful for IIT-JEE, CBSE, I.Sc. PU-II, Boards, CET, CEE, PET, IGCSE IB AP-Physics and other exams

Newton 's Law of Cooling by Prof. Subhashish Chattopadhyay SKMClasses Bangalore Useful for IIT-JEE, CBSE, I.Sc. PU-II, Boards, CET, CEE, PET, IGCSE IB AP-Physics and other exams

respectively, and other components such as neutrinos and photons contribute a very small amount. Again, on a mass-energy equivalence basis, the density of dark energy ($\sim 7 \times 10^{-30} \text{ g/cm}^3$) is very low, much less than the density of ordinary matter or dark matter within galaxies. However, it comes to dominate the mass-energy of the universe because it is uniform across space.

In quintessence models of dark energy, the observed acceleration of the scale factor is caused by the potential energy of a dynamical field, referred to as quintessence field. Quintessence differs from the cosmological constant in that it can vary in space and time. In order for it not to clump and form structure like matter, the field must be very light so that it has a large Compton wavelength.

No evidence of quintessence is yet available, but it has not been ruled out either. It generally predicts a slightly slower acceleration of the expansion of the universe than the cosmological constant. Some scientists think that the best evidence for quintessence would come from violations of Einstein's equivalence principle and variation of the fundamental constants in space or time. Scalar fields are predicted by the Standard Model of particle physics and string theory, but an analogous problem to the cosmological constant problem (or the problem of constructing models of cosmological inflation) occurs: renormalization theory predicts that scalar fields should acquire large masses.

Some theorists think that dark energy and cosmic acceleration are a failure of general relativity on very large scales, larger than superclusters. However most attempts at modifying general relativity have turned out to be either equivalent to theories of quintessence, or inconsistent with observations. Other ideas for dark energy have come from string theory, brane cosmology and the holographic principle, but have not yet proved; as compelling as quintessence and the cosmological constant. In other hand, M.R. Khoshbin-e-Khoshnazar believes that a model discretization of the universe could explain the origin of dark energy.

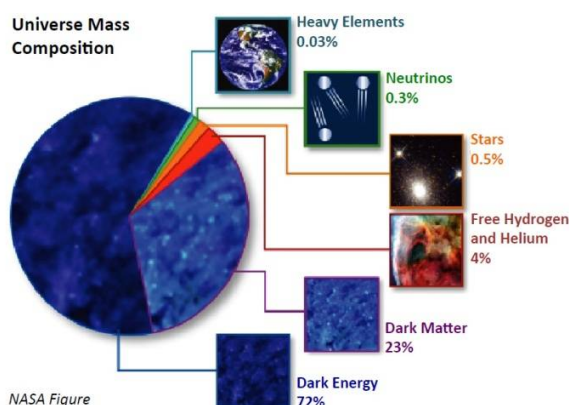

If an Atom is of the size of Earth, the Nucleus is of the size of an Apple! Physicists say, in Science videos. To draw an analogy, Physicists say... If the atom is of the size of Universe, the string is of the size of a tree! This needs 10^{18} times more energy than present technology

Newton 's Law of Cooling by Prof. Subhashish Chattopadhyay SKMClasses Bangalore Useful for IIT-JEE, CBSE, I.Sc. PU-II, Boards, CET, CEE, PET, IGCSE IB AP-Physics and other exams

Newton 's Law of Cooling by Prof. Subhashish Chattopadhyay SKMClasses Bangalore Useful for IIT-JEE, CBSE, I.Sc. PU-II, Boards, CET, CEE, PET, IGCSE IB AP-Physics and other exams

allows us to verify. I read somewhere that if a [huge particle accelerator like a ring around the Earth](#) or say along the perimeter of Earth is made (**which is just not possible**), then the experiments may hint about the ranges which String theory is talking about.

The Mathematical elegance that String Theory was so excited about, did not predict Dark Matter, Dark energy etc. Today we know that more than 95% of the Universe is of Dark Matter + Dark Energy. Many simple and "normal" calculations explain all these **without Multiple Universe**. These calculations have last 100 years of experimental backup, and Madala Boson is being used to explain Dark World. Physicists are doing fine with 4 dimensions. (x, y, z and time). Since 1910s Einstein's equations gave relations between space and time. Since then time is the 4 rth dimension. We did not require any more dimensions to explain experimental observations, for last 100 years!

If I have 100 hours or 1000 hours of time, it will be much more useful and profitable for me to read, research and do Business with **Artificial Chlorophyll**, Bio-Batteries, Bacteria Motors / energy, Desalination technologies for cheap potable water from sea, etc; rather than wasting time in high Energy Physics, or Theoretical constructs of Modification of Superstring theory!

-

Newton 's Law of Cooling by Prof. Subhashish Chattopadhyay SKMClasses Bangalore Useful for IIT-JEE, CBSE, I.Sc. PU-II, Boards, CET, CEE, PET, IGCSE IB AP-Physics and other exams

About Christopher Hitchens (1949-2011)

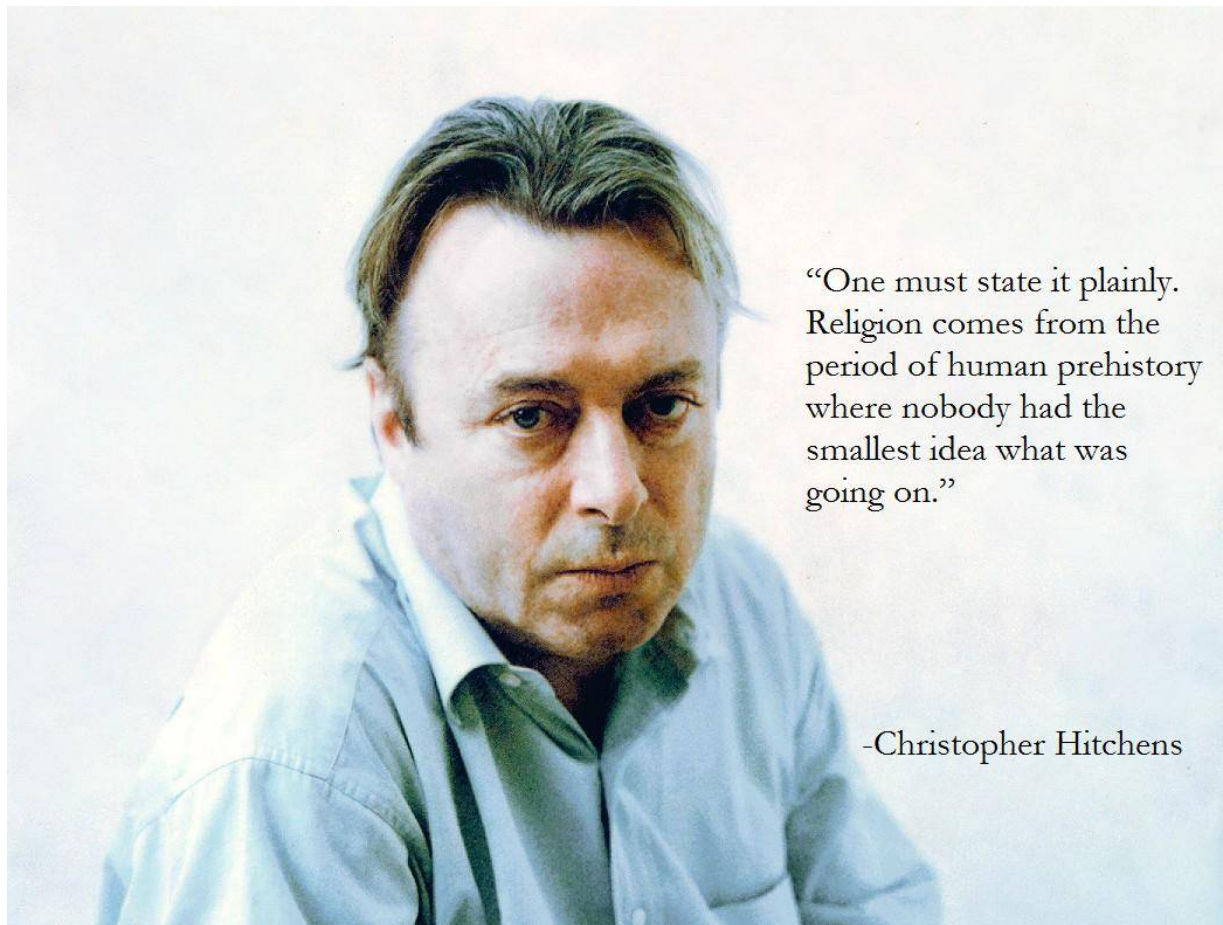

Christopher was an Anglo-American author, columnist, essayist, orator, religious and literary critic, social critic, and journalist. He contributed to *New Statesman*, *The Nation*, *The Atlantic*, *London Review of Books*, *The Times Literary Supplement*, *Slate*, and *Vanity Fair*. Hitchens was the author, co-author, editor or co-editor of over 30 books, including five collections of essays, on a range of subjects, including politics, literature, and religion. A staple of talk shows and lecture circuits, his confrontational style of debate made him both a lauded and controversial figure and public intellectual. Known for his contrarian stance on a number of issues, Hitchens criticised such public and generally popular figures as Mother Teresa, Bill Clinton, Henry Kissinger, and Diana, Princess of Wales. He was the elder brother of the conservative journalist and author Peter Hitchens.

A writer who could match the volume of exquisitely crafted columns, essays, articles, and books he produced over the past four decades. He wrote often—constantly, in fact, and right up to the end—and he wrote fast; frequently without the benefit of a second draft or even corrections. Christopher was the beau ideal of the public intellectual. You felt as though he was writing to you and to you alone. And as a result many readers felt they knew him.

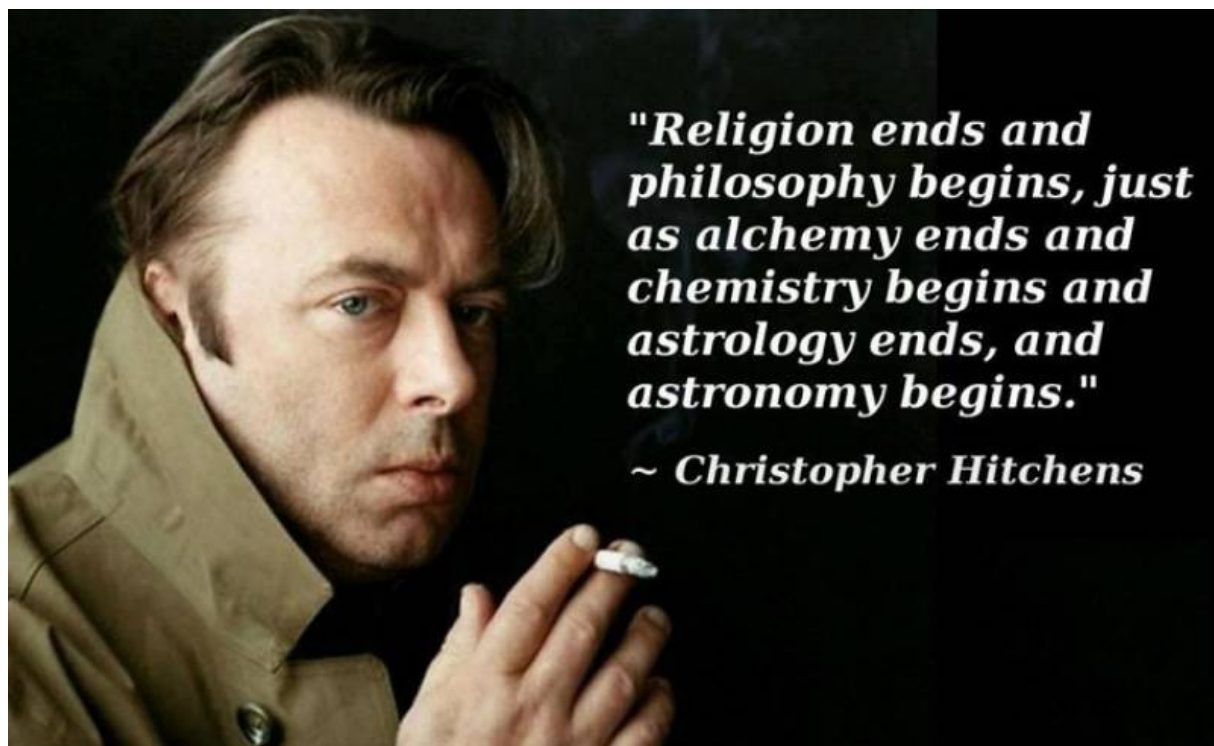

He was a legend on the speakers' circuit, and could debate just about anyone on anything. He won umpteen awards—although that was not the sort of thing that fueled his work—and in the last decade he wrote best-sellers, including a memoir, *Hitch-22*, that finally put some money into his family's pocket. In the last weeks of his life, he was told that an asteroid had been named after him. He was pleased by the thought, and inasmuch as the word is derived from the Greek, meaning "star-like," and asteroids are known to be volatile, it is a fitting honor.

Having long described himself as a socialist, a Marxist and an anti-totalitarian, Hitchens began his break from the established political left after what he called the "tepid reaction" of the Western left to the controversy over *The Satanic Verses*, followed by the left's embrace of Bill Clinton, and the antiwar movement's opposition to NATO intervention in Bosnia and Herzegovina in the 1990s.

An atheist, and a self-described antitheist, Hitchens viewed the concept of a god or a supreme being as a totalitarian belief that destroys individual freedom, and argued free expression and scientific discovery should replace religion as a means of teaching ethics and defining human civilisation. In 2007, Hitchens published his most popular book, *God Is Not Great: How Religion Poisons Everything*, which was a New York Times bestseller.

Newton 's Law of Cooling by Prof. Subhashish Chattopadhyay SKMClasses Bangalore Useful for IIT-JEE, CBSE, I.Sc. PU-II, Boards, CET, CEE, PET, IGCSE IB AP-Physics and other exams

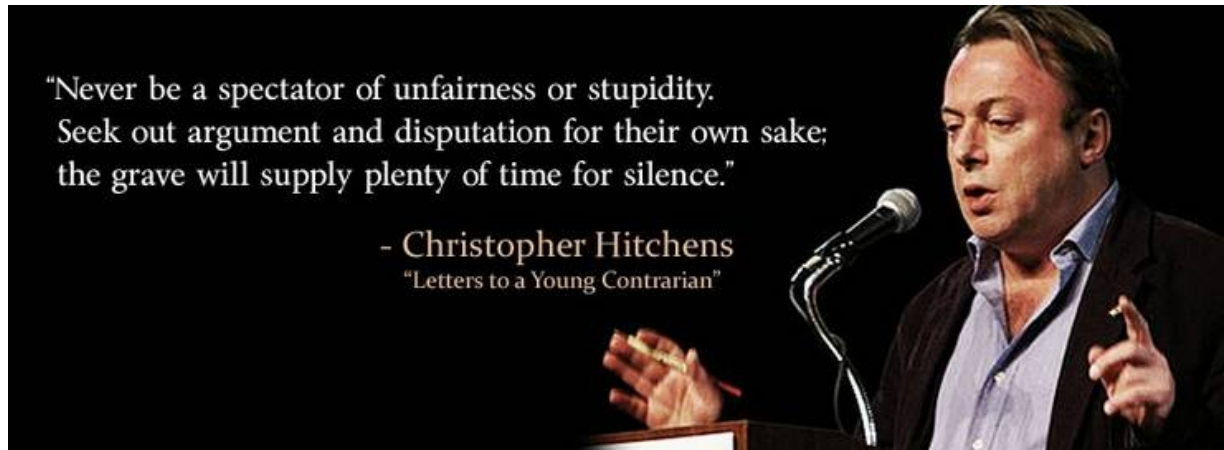

[About Sir Nicholas Winton](#) (1909 - 2015)



Sir Nicholas George Winton was a British humanitarian who organized the rescue of 669 children, most of them Jewish, from Czechoslovakia on the eve of the Second World War in an operation later known as the Czech Kindertransport (German for "children transportation"). Winton found homes for the children and arranged for their safe passage to Britain. The world found out about his work over 40 years later, in 1988. The British press dubbed him the "British Schindler". On 28 October 2014, he was awarded the highest honour of the Czech Republic, the Order of the White Lion (1st class), by Czech President Miloš Zeman.

Newton 's Law of Cooling by Prof. Subhashish Chattopadhyay SKMClasses Bangalore Useful for IIT-JEE, CBSE, I.Sc. PU-II, Boards, CET, CEE, PET, IGCSE IB AP-Physics and other exams

About Vaclav Havel (1936 - 2011)

Playwright, poet, essayist, dissident, human rights activist, and statesman are but a few of the monikers that have been used to describe Václav Havel, ...

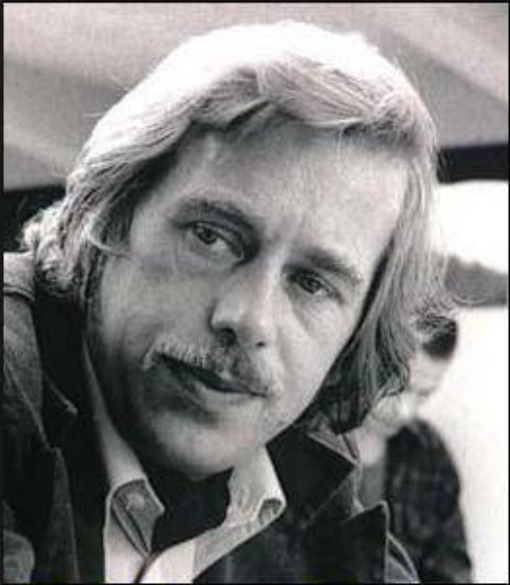

Vaclav Havel
The dissident - 1979

"Because the regime is captive to its own lies, it must falsify everything. It falsifies the past. It falsifies the present, and it falsifies the future. It falsifies statistics.

"It pretends not to possess an omnipotent and unprincipled police apparatus. It pretends to respect human rights. It pretends to prosecute no one. It pretends to fear nothing. It pretends to pretend nothing."

1936 to 2011 Persuasion Redefined

Vaclav Havel was a Czech writer, philosopher, political dissident, and statesman. From 1989 to 1992, he served as the last president of Czechoslovakia. He then served as the first president of the Czech Republic (1993-2003) after the Czech-Slovak split. Within Czech literature, he is known for his plays, essays, and memoirs.

His educational opportunities limited by his bourgeois background, Havel first rose to prominence within the Prague theater world as a playwright. Havel used the absurdist style in works such as *The Garden Party* and *The Memorandum* to critique communism. After participating in Prague Spring and being blacklisted after the invasion of Czechoslovakia, he became more politically active and helped found several dissident initiatives such as Charter 77 and the Committee for the Defense of the Unjustly Prosecuted. His political activities brought him under the surveillance of the secret police and he spent multiple stints in prison, the longest being nearly four years, between 1979 and 1983.

Havel's Civic Forum party played a major role in the Velvet Revolution that toppled communism in Czechoslovakia in 1989. He assumed the presidency shortly thereafter, and was reelected in a landslide the following year and after Slovak independence in 1993. Havel was instrumental in dismantling the Warsaw Pact and expanding NATO membership eastward. Many of his stances and policies, such as his opposition to Slovak independence, condemnation of the Czechoslovak treatment of Sudeten Germans after World War II, and granting of general amnesty to all those imprisoned under communism, were very controversial domestically. As such, he continually enjoyed greater popularity abroad than at

Newton 's Law of Cooling by Prof. Subhashish Chattopadhyay SKMClasses Bangalore Useful for IIT-JEE, CBSE, I.Sc. PU-II, Boards, CET, CEE, PET, IGCSE IB AP-Physics and other exams

home. Havel continued his life as a public intellectual after his presidency, launching several initiatives including the Prague Declaration on European Conscience and Communism, the VIZE 97 Foundation, and the Forum 2000 annual conference.

Havel's political philosophy was one of anti-consumerism, humanitarianism, environmentalism, civil activism, and direct democracy. He supported the Czech Green Party from 2004 until his death. He received numerous accolades during his lifetime including the Presidential Medal of Freedom, the Gandhi Peace Prize, the Philadelphia Liberty Medal, the Order of Canada, the Four Freedoms Award, the Ambassador of Conscience Award, and the Hanno R. Ellenbogen Citizenship Award. The 2012–2013 academic year at the College of Europe was named in his honour. He is considered by some to be one of the most important intellectuals of the 20th century.

During the first week of the invasion of Czechoslovakia, Havel assisted the resistance by providing an on-air narrative via Radio Free Czechoslovakia station (at Liberec). Following the suppression of the Prague Spring in 1968, he was banned from the theatre and became more politically active. Short of money, he took a job in a brewery, an experience he wrote about in his play *Audience*. This play, along with two other "Vaněk" plays (so-called because of the recurring character Ferdinand Vaněk, a stand in for Havel), became distributed in samizdat form across Czechoslovakia, and greatly added to Havel's reputation of being a leading dissident (several other Czech writers later wrote their own plays featuring Vaněk). This reputation was cemented with the publication of the Charter 77 manifesto, written partially in response to the imprisonment of members of the Czech psychedelic rock band The Plastic People of the Universe. (Havel had attended their trial, which centered on the group's non-conformity in having long hair, using obscenities in their music, and their overall involvement in the Czech underground). Havel co-founded the Committee for the Defense of the Unjustly Prosecuted in 1979. His political activities resulted in multiple stays in prison, and constant government surveillance and questioning by the secret police, (*Státní bezpečnost*). His longest stay in prison, from May 1979 to February 1983, is documented in letters to his wife that were later published as *Letters to Olga*.

He was known for his essays, most particularly *The Power of the Powerless*, in which he described a societal paradigm in which citizens were forced to "live within a lie" under the communist regime. In describing his role as a dissident, Havel wrote in 1979: "...we never decided to become dissidents. We have been transformed into them, without quite knowing how, sometimes we have ended up in prison without precisely knowing how. We simply went ahead and did certain things that we felt we ought to do, and that seemed to us decent to do, nothing more nor less."

Newton 's Law of Cooling by Prof. Subhashish Chattopadhyay SKMClasses Bangalore Useful for IIT-JEE, CBSE, I.Sc. PU-II, Boards, CET, CEE, PET, IGCSE IB AP-Physics and other exams

[About Irena Sendler](#) (1910 - 2003)



Irena Sendler (née Krzyżanowska), also referred to as Irena Sendlerowa in Poland, nom de guerre "Jolanta", was a Polish nurse and social worker who served in the Polish Underground in German-occupied Warsaw during World War II, and was head of the children's section of Żegota, the Polish Council to Aid Jews (Polish: Rada Pomocy Żydom), which was active from 1942 to 1945.

Assisted by some two dozen other Żegota members, [Sendler smuggled approximately 2,500 Jewish children out of the Warsaw Ghetto and then provided them with false identity documents and shelter outside the Ghetto, saving those children from the Holocaust.](#) With the exception of diplomats who issued visas to help Jews flee Nazi-occupied Europe, Sendler saved more Jews than any other individual during the Holocaust.

The German occupiers eventually discovered her activities and she was arrested by the Gestapo, tortured, and sentenced to death, but she managed to evade execution and survive the war. In 1965, Sendler was recognised by the State of Israel as Righteous among the Nations. Late in life she was awarded the Order of the White Eagle, Poland's highest honor, for her wartime humanitarian efforts.

Jewish children were placed with Polish families, the Warsaw orphanage of the Sisters of the Family of Mary, or Roman Catholic convents such as the Little Sister Servants of the Blessed Virgin Mary Conceived Immaculate. Sendler worked closely with a group of about 30 volunteers, mostly women, who included Zofia Kossak-Szczucka, a resistance fighter and writer, and Matylda Getter, Mother Provincial of the Franciscan Sisters of the Family of Mary.

Newton 's Law of Cooling by Prof. Subhashish Chattopadhyay SKMClasses Bangalore Useful for IIT-JEE, CBSE, I.Sc. PU-II, Boards, CET, CEE, PET, IGCSE IB AP-Physics and other exams

"Every child saved with my help is the justification of my existence on this Earth, and not a title to glory." (Irena Sendler)

According to American historian Debórah Dwork, Sendler was "the inspiration and the prime mover for the whole network that saved those 2,500 Jewish children." About 400 of the children were directly smuggled out by Sendler herself. She and her co-workers buried lists of the hidden children in jars in order to keep track of their original and new identities. The aim was to return the children to their original families when the war was over.

In 1943 Sendler was arrested **by the Gestapo and severely tortured. The Gestapo beat her brutally, fracturing her feet and legs in the process.** Despite this, she refused to betray any of her comrades or the children they rescued, and was sentenced to death by firing squad. Żegota saved her life by bribing the guards on the way to her execution. After her escape, she hid from the Germans, but returned to Warsaw under a fake name and continued her involvement with the Żegota. During the Warsaw Uprising, she worked as a nurse in a public hospital, where she hid five Jews. She continued to work as a nurse until the Germans left Warsaw, retreating before the advancing Soviet troops.

After the war, she and her co-workers gathered all of the children's records with the names and locations of the hidden Jewish children and gave them to their Żegota colleague Adolf Berman and his staff at the Central Committee of Polish Jews. However, almost all of the children's parents had been killed at the Treblinka extermination camp or had gone missing.

After the war, Sendler was imprisoned from 1948 to 1949 and brutally interrogated by the communist secret police (Urząd Bezpieczeństwa) due to her connections with Poland's principal resistance organisation, the Home Army (AK), which was loyal to the wartime Polish government in exile. As a result, she gave birth prematurely to her son, Andrzej, who did not survive. Although she was eventually released and agreed to join the communist party (PZPR), her ties to the AK meant that she was never made into a hero. In fact, in 1965 when Sendler was recognized by Yad Vashem as one of the Polish Righteous among the Nations, Poland's communist government did not allow her to travel abroad at that time to receive the award in Israel; she was able to do so only in 1983. She was later employed as a teacher and vice-director in several Warsaw medical schools, and worked for the Ministries of Education and Health. She was also active in various social work programs. She helped organize a number of orphanages and care centers for children, families and the elderly, as well as a center for prostitutes in Henryków. However, she was forced into early retirement for her public declarations of support for Israel in the 1967 Israeli-Arab War (countries of the Soviet-controlled Eastern Bloc, including Poland, broke off diplomatic relations with Israel in the aftermath of this war). Sendler resigned her PZPR membership following the events of March 1968 in Poland.

In 1980 she joined the Solidarity movement.

-

Newton 's Law of Cooling by Prof. Subhashish Chattopadhyay SKMClasses Bangalore Useful for IIT-JEE, CBSE, I.Sc. PU-II, Boards, CET, CEE, PET, IGCSE IB AP-Physics and other exams

Newton 's Law of Cooling by Prof. Subhashish Chattopadhyay SKMClasses Bangalore Useful for IIT-JEE, CBSE, I.Sc. PU-II, Boards, CET, CEE, PET, IGCSE IB AP-Physics and other exams

Since Many years there are too many articles on Women Sex Predators, and aggressive women



Motherly Love Redefined ...

<http://crimeblog.dallasnews.com/2016/05/prosper-woman-who-had-sex-with-sons-teenage-friend-headed-to-prison.html/>

<http://www.wtol.com/story/6975375/mother-sentenced-for-having-sex-with-son>

<http://www.dailymail.co.uk/news/article-2716412/Mother-jailed-having-sex-12-year-old-SON-partner-watched-told-webcam.html>

<http://www.dreamindemon.com/2012/05/18/mistie-atkinson-mother-pleads-guilty-sex-teenage-son/>

<http://patch.com/california/dixon/vacaville-mom-convicted-sex-son-seeks-retrial-0>

<http://www.nhregister.com/article/NH/20120921/NEWS/309219751>

http://articles.orlandosentinel.com/1996-10-27/news/9610260994_1_extorting-endangerment-elementary-school-principal

<http://www.independent.ie/irish-news/incest-mother-is-convicted-of-sex-assault-on-her-two-sons-26462211.html>

http://canadiancrc.com/newspaper_articles/Tor_Star_Mother_confesses_sex_with_sons_030CT04.aspx

Newton 's Law of Cooling by Prof. Subhashish Chattopadhyay SKMClasses Bangalore Useful for IIT-JEE, CBSE, I.Sc. PU-II, Boards, CET, CEE, PET, IGCSE IB AP-Physics and other exams

SEX WITH MY STUDENTS: THE TEACHERS WHO HAVE BEEN ARRESTED, CHARGED OR JAILED OVER THE PAST SCHOOL YEAR

Angela New, 39, from Gladewater, Texas, was arrested last week after school chiefs at Union Grove High School, where she taught English received a tip off about an alleged affair between her and an 18-year-old student.



Had the offence taken place a month later - after the teen graduated - she might not have been charged as he was no longer a full-time student and at the age of consent.

April Alexander, 26, from Irving, Texas, was last week arrested after being accused of having sex with a 16-year old student on more than 25 occasions.



The teen, now 18, told police he and the biology teacher had sex on more than two dozen occasions at MacArthur High School in Irving and in Alexander's car.

Brittni Colleps, 27, from Arlington, Texas, was arrested last week after being accused of having sex with five of her teenage students during an orgy at her home.



The English teacher and girl's basketball coach at Kennedale High School allegedly invited the boys to her home while her husband was away with the military and the sex romp was allegedly filmed on the students' cell phones. The married mother-of-three faces up to ten years in jail.

Michelle McCutchan, 38, was jailed in Checotah, Oklahoma, after admitting making a sex tape with her daughter's 16-year-old boyfriend.



The mother-of-one confessed to having sex with the teen on at least five occasions and setting up a video camera to film two of the romps.

<http://www.thedailybeast.com/articles/2014/06/10/canada-s-newest-refugee-a-florida-mom-convicted-of-unlawful-sex-with-a-minor.html>

<http://www.ibtimes.co.uk/us-idaho-lawsuit-reveals-sexual-assault-by-staff-male-teens-juvenile-detention-centers-1494582>

<http://www.mirror.co.uk/news/world-news/biology-teacher-who-sex-five-8850667>

<http://www.littlethings.com/foster-child-wwyd/>

<https://www.youtube.com/watch?v=htrItTaroZA>

<https://www.youtube.com/watch?v=MC7hfCaRHIO>

<http://www.gympietimes.com.au/news/roma-mother-guilty-of-bruising-sons-genitals/3089847/>

<http://www.breitbart.com/big-government/2016/09/14/mother-arranged-rape-murder-10-yr-old-daughter-allegedly-said-liked-watch/>

<http://thesmokinggun.com/buster/cigarette/cigarette-in-eye-628759#>

SEX WITH MY STUDENTS: THE TEACHERS WHO HAVE BEEN ARRESTED, CHARGED OR JAILED OVER THE PAST SCHOOL YEAR

Nicole Chapman, 28, was this month jailed for 10 to 12 months earlier this month for having sex with a 19-year-old special needs student in North Carolina.

Bizarrely the teenager's mother approved of the relationship between her son and the ex North Shelby teacher and told local TV: 'I ain't no victim. If it is love, man, it's love. Nobody can stop this.'



Marie L Fisher, 21, was last month charged with having a sexual relationship with a 15-year-old boy after sending him explicit text messages.

Fisher, who worked in the Special Education Department at Reeds High School in Sparks, Nevada, is alleged to have sent him a photo of her 'half naked breast' and later slept with him.



Bethyl Shepherd, 34, who worked in the same department as Fisher, was arrested last month after officials found out about an alleged threesome with two 17-year-old students.

Shepherd, who had taught at the school for 10 years, claimed one of the teens forced her to have sex while the other watched.



Barbara Anderson, 37, a teacher at a Washington State school, was arrested in March after allegedly having sex with a 17-year-old student.

The pupil in question told his uncle he was 'getting laid by a teacher,' according to court documents. She sent almost 800 text messages to the boy between January 15 and February 21, including more than 100 texts in one 24-hour period.



<http://equalitycanada.com/why-are-so-many-women-raping-boys-research-into-female-perpetrated-sexual-violence/>

<http://www.theindychannel.com/news/local-news/teacher-accused-of-sex-with-student-10-times-reaches-plea-deal-for-1-count-of-child-seduction>

<http://www.news.com.au/world/florida-mum-rachael-leahy-ordered-hit-on-exhusband-david-leahy/news-story/11b25d3fd6c5e007132d7fe28a4f7de1>

<http://www.9news.com.au/national/2016/09/14/07/26/poisoned-meatball-accused-due-in-vic-court/>

http://www.bostonherald.com/news/local_coverage/2016/09/saugus_mom_pleads_guilty_to_rape_of_two_teenage_boys

<http://www.express.co.uk/news/world/656971/Bullies-bikinis-attacked-sunbathing-victim-filmed-assault>

<http://www.bustle.com/articles/123975-6-signs-you-have-a-toxic-mother>

<http://txktoday.com/news/new-boston-woman-pleads-guilty-to-sexually-assaulting-13-year-old-boy/>

SEX WITH MY STUDENTS: THE TEACHERS WHO HAVE BEEN ARRESTED, CHARGED OR JAILED OVER THE PAST SCHOOL YEAR

Jamie Waite, 35, a swimming instructor at a school in Utah, was arrested in March for allegedly having sexual relations with a 17-year-old student.



Police in Utah arrested the teacher after a tip off from friends of the student who claimed the pair were having a relationship.

Deborah J Cox, 58, of Naperville became involved with the boy while he was at Neuqua Valley High School, police said.



The teacher's aide, had been the boy's personal academic tutor for several years, before she was arrested in March for having an alleged sexual relationship with him.

Carrie Shafer, 38, a biology teacher, was caught in March by police partially naked in a car with one of her students.



An arrest report revealed the married mother-of-two, from Kentucky, was in a compromising position with a 17-year-old student from her school in Louisville. Police said the windows of the car were 'steamed up' and both occupants were partially clothed.

Gail Gagne, 29, a weight room supervisor at Cretin-Derham Hall High School, Minnesota, was sentenced to two years probation in February after having sex with a then 16-year-old student - both at her home in Bloomington and at a nearby hotel.



<http://www.ibtimes.co.uk/married-teacher-who-had-affair-14-year-old-pupil-sent-him-video-online-charged-rape-1579807>

<http://www.dailymail.co.uk/news/article-3782055/Furious-bride-24-bit-fiance-s-ear-slashed-face-broken-glass-wedmin-meetings-went-horribly-wrong.html>

<http://www.nydailynews.com/news/national/conn-woman-drowned-baby-shorter-sentence-article-1.2783131>

<https://www.theguardian.com/commentisfree/2015/oct/06/children-older-women-abused-jade-hatt>

<http://thechannelhiphop.com/boyfriend-saw-his-girlfriend-having-sex-with-two-dogs-and-called-the-police/>

<http://www.telegraph.co.uk/news/uknews/law-and-order/5251042/Rise-of-ladette-culture-as-241-women-arrested-each-day-for-violence.html>

<http://www.thespectrum.com/story/news/2016/06/07/18-year-old-laverkin-woman-arrested-having-sex-15-year-old-boys/85571780/>

http://www.huffingtonpost.com/2013/11/09/nicole-kurowski-teacher-sex_n_4241276.html

SEX WITH MY STUDENTS: THE TEACHERS WHO HAVE BEEN ARRESTED, CHARGED OR JAILED OVER THE PAST SCHOOL YEAR

Chanda Frank, 34, a physical education coach at Haywood High in Brownsville, was charged with sexual battery in February, after allegedly fondling a 14-year-old female student on her softball team.



It happened at least twice between the dates of August 2010 and February 2011, according to court documents.

Stacy Schuler, 32, of Mason, Ohio, was charged with committing sex acts with students from her high school football team in February.



She faces 19 felony counts of sexual battery involving five male students, three misdemeanor charges of serving alcohol to underage youths and more than 96 years in prison if convicted.

Ashley Blumenshine, 27, a PE and dance teacher was arrested in January behind a department store in Plainfield, Illinois, after police caught her in a car with a 16-year-old boy student.



Police believe they had had sex shortly before the officers arrived and say the relationship may have gone on for more than a month.

Courtney Bowles, 31, a teacher who advised colleagues on how to avoid affairs with students, was caught having sex with a teenager in her car.



Bowles was found by a police officer lying naked on top of the boy, who was also naked, from her school in Colorado. A partly consumed bottle of vodka was also found in the car with the couple.

<http://www.craveonline.com/site/1062074-uk-teacher-had-sex-with-15-year-old-more-than-50-times-claimed>

<http://www.sun-sentinel.com/local/broward/fl-female-bank-robbers-20160722-story.html>

<http://www.heraldsun.com.au/news/law-order/fight-to-extradite-ultraorthodox-jewish-school-principal-accused-of-molesting-and-raping-students-dropped/news-story/194cad2f934cca5858500ffebf4858c4>

<https://www.theguardian.com/society/2009/oct/04/uk-female-child-sex-offenders>

<http://www.adelaidenow.com.au/news/south-australia/woman-who-tried-to-kill-exs-new-girlfriend-unable-to-show-empathy-for-her-victim-court-told/news-story/7b22da29e8cc18e413269a0be58800b0>

<https://www.youtube.com/watch?v=syWtUyKs7L0>

https://www.youtube.com/watch?v=3g_OPKvDgpU

<https://www.youtube.com/watch?v=VPI5PkjVs3A>

<https://www.youtube.com/watch?v=AFk1FyKDYec>

<https://www.youtube.com/watch?v=oln5OfNFa5I>

SEX WITH MY STUDENTS: THE TEACHERS WHO HAVE BEEN ARRESTED, CHARGED OR JAILED OVER THE PAST SCHOOL YEAR

Marcie Lynn Rousseau, 34, had sex with a 16-year-old student at least 100 times.

The Michigan English teacher was sent to prison last December to serve a minimum of four years having pleaded guilty to all the charges.

But her defence lawyer said of the student: 'He took part in this also ... He courted her, bought her lunch, brought her flowers.'



Megan Baumann, 28, is currently serving three years in prison after pleading guilty to various sex charges involving three male students.

The social sciences teacher had sex with one and sent him naked pictures of herself by text. The former Tennessee teacher sent texts of her breasts and pubic region to another while she fondled the third while he was clothed.



Jennifer Riojas, 27, a science teacher in Fort Worth, Texas, was pregnant when arrested for sexual assault in November after allegedly having sex with a 16-year-old student.

The pupil told police they met in motels and even had sex when he was in a hospital bed recovering from a football injury.



Carlie Rose Attebury, 31, a former California marching band teacher, denied having sex with a 15-year-old student but admits having sex with two former students when they were 18. Attebury said that she hugged the 15-year-old boy as she did any 'band kid'. She was sentenced to 16 months in prison in March.



<http://www.dailymail.co.uk/news/article-3274956/Disturbing-rise-women-child-sex-predators-s-punished-leniently-men.html?ito=social-facebook>

<https://www.youtube.com/watch?v=L5gWMO2JPa4>

<https://www.youtube.com/watch?v=76rAn4JZfiA>

<https://www.youtube.com/watch?v=W5RJBcsQq7Q>

<https://www.youtube.com/watch?v=yXAM83Lq8d0>

<https://www.youtube.com/watch?v=XfxkVjawYYg>

https://www.youtube.com/watch?v=4_Uum7tEUqg

<https://www.youtube.com/watch?v=D3ILPAUmPrw&list=PLfqvIEGoZYGzaCWw7VPYrY6sCtkbxOat8>

<https://www.youtube.com/watch?v=H6a9Szp8FwY>

<https://www.youtube.com/watch?v=p-GLJUPrtNU>

<https://www.youtube.com/watch?v=8uDEB2KG9XU>

SEX WITH MY STUDENTS: THE TEACHERS WHO HAVE BEEN ARRESTED, CHARGED OR JAILED OVER THE PAST SCHOOL YEAR

Elizabeth Colleen Wallis, 34, was sentenced in March to four months in the Yuba County Jail for having sex with a former underage special needs student now 17.



Wallis a teacher's assistant at Yuba Gardens Intermediate School in Olivehurst, California, came to the attention of police when they were notified of the alleged inappropriate relationship by a concerned family member of Wallis.

The boy's mother had indicated that her son was in love with Wallis.

Kimme Woolf, was a 29-year-old math teacher at Perrin High School in Perrin, Texas, when she was arrested for allegedly committing sexual assault on a male student, 16, and having an improper relationship with another, 18, last November.



Woolf is alleged to have slept with both boys after they repeatedly asked for sex. She is also thought to have performed oral sex on both.

Felecia Killings, 27, an English teacher at Rodriguez High School in Fairfield, California was arrested in November on allegations of having sex with a 16-year-old student.



Police believe the alleged relations took place at Killings' home.

Sara Leann Dwigins, 24, a math teacher at South Creek Middle School in Williamston, North Carolina, was arrested on allegations of having sex with a 14-year-old former student. She has been charged with two counts of statutory rape and two counts of sex offence with a student.



Gina Watring, 40, was jailed for five years last September after admitting having sex with a boy, 10, at the primary school in Durham, North Carolina. The mother-of-two had faced up to 70 years after being charged with dozens of offences.



A Psychologist has an explanation ...

<http://www.dailymail.co.uk/news/article-1391626/Whats-wrong-female-teachers-America-As-schools-summer-young-teacher-arrested-sex-16-year-old-student--latest-dozens-cases-school-year.html>

https://www.youtube.com/watch?v=vWikSI0j_wA

A Mother Who Killed Her 5 Children

<https://www.youtube.com/watch?v=Mp-zuabUeXU>

<https://www.youtube.com/watch?v=tz7DCorxLbo>

<https://www.youtube.com/watch?v=jf6VU5meuho>

<https://www.youtube.com/watch?v=gEP0k4ZMFfk>

<https://www.youtube.com/watch?v=vfVFkIqG0NM>

Newton 's Law of Cooling by Prof. Subhashish Chattopadhyay SKMClasses Bangalore Useful for IIT-JEE, CBSE, I.Sc. PU-II, Boards, CET, CEE, PET, IGCSE IB AP-Physics and other exams

Why are Modern Women so aggressive ?



Why are modern women so aggressive? The dark side of equality

Gemma Dawson, 27, from Wakefield, (left), Jo Scott, 51, from Sussex, (centre) and Annmarie Fisher, 32, form Iver, (right) reveal what makes them angry and why.

DAILYMAIL.CO.UK

<https://www.theguardian.com/education/2006/jan/23/pupilbehaviour.schools>



Female Sex Predators: A Crime Epidemic

13 hrs · 🌐

More perverts



Model walks topless through New York in support of Free The Nipple

Model Emily Bloom, 23, has bravely walked topless through New York City in support of the Free The Nipple campaign for gender equality, leaving passers-by...

DAILYMAIL.CO.UK

See <https://www.facebook.com/WomenCriminals/>

Newton 's Law of Cooling by Prof. Subhashish Chattopadhyay SKMClasses Bangalore Useful for IIT-JEE, CBSE, I.Sc. PU-II, Boards, CET, CEE, PET, IGCSE IB AP-Physics and other exams



North Carolina woman, 45, arrested for having sex with adult son

A 45-year-old North Carolina woman and her 25-year-old son have been arrested for having sex with each other.

NYDAILYNEWS.COM



Girl rushes field at college world series, proceeds to grab every player's butt.



Frank Meza

If a man would have done that to a woman's soccer or volleyball game he would have been jailed as a sex offender and sued for sexual harassment faster than you could say "feminism isn't about equality".

See <https://www.facebook.com/groups/499811210056249/>

Published on Sep 14, 2016 | Updated 3 days ago | By Susmita Pathak Mishra | In Featured, World News

Police have charged a North Carolina mom-son pair with **incest** after an August report claimed that they had sex with each other.

Forty-four-year-old Melissa Nell Kitchens shared a sexual relationship with 25-year-old son Shaun Thomas Pfeiffer. As soon as the matter became known to the police, Buncombe County Police started investigating, after which the duo was arrested. Both suspects are due to appear in court later in September.

“Can’t get over how handsome you are and I’m about to cry,” one of the Facebook posts of Kitchens stated. The post was accompanied by the picture of her son. “Things are very stressful and I love you and I respect any decision — as long as you’re happy and safe ... I miss you and wish I had more time with you.”

The **arrest** warrants stated the counts of charges on the suspects. Mother and son have both been charged with one count of incest. Where the mother had sex with her son, who is already married to Shannon Roman and has a young son, the son is also due to face charges of indecent liberties with a child. The latter incident took place on August 13 when Pfeiffer communicated threats and behaved disruptively.

<http://www.australianetworknews.com/melissa-kitchens-incest-american-mom-sex-son-25-gets-arrested/>

<http://www.irishtimes.com/news/crime-and-law/waterford-mother-convicted-of-child-cruelty-following-seven-week-trial-1.2657598>

<http://www.fox19.com/story/32236822/convicted-sex-offender-asks-mother-of-14-year-old-i-want-her-what-do-you-want-for-it>

<http://www.insideedition.com/headlines/16733-mom-and-female-partner-convicted-of-torturing-murdering-2-year-old-son-who-fell-off>

<https://www.rt.com/uk/354212-wales-mother-porn-court/>

<http://q13fox.com/2016/02/04/marysville-mother-convicted-of-sex-crimes-involving-daughter/>

<http://www.charlotteobserver.com/news/local/crime/article77122242.html>

http://www.omaha.com/bellevue-mom-convicted-of-sexually-abusing-son-gets--/article_1393b0df-a383-58c3-a8e7-e5af713cc630.html

http://www.huffingtonpost.in/entry/wisconsin-mom-sentenced-sex-crimes-toddler_n_6237550

Newton 's Law of Cooling by Prof. Subhashish Chattopadhyay SKMClasses Bangalore Useful for IIT-JEE, CBSE, I.Sc. PU-II, Boards, CET, CEE, PET, IGCSE IB AP-Physics and other exams

A mother accused of sexually seducing her underage son's friend during a sleepover, telling him he could 'pretend to be 18 for the night,' was arrested March 1.

36-year-old Wendy Crowell now faces seven criminal charges, six of which are felonies, tied to sexual assault on a minor between 15 and 16 years old.

SCROLL DOWN FOR VIDEO

When a police detective questioned Crowell at her Grand Junction, Colorado home, she claimed she exchanged texts with all her son's friends.

A gut feeling led the boy's mother to suspect a possible relationship between her son and Crowell.



Naughty mom: Wendy Crowell of Grand Junction, Colorado is accused of having sex with her son's underage friend multiple times

<http://www.dailymail.co.uk/news/article-2287494/Grand-Junction-mom-Wendy-Crowell-sex-sons-underage-best-friend.html>

<http://www.vindy.com/news/2011/oct/06/pa-mom-sentenced-for-sex-with-son8217s-t/>

<http://www.murfreesboropost.com/mother-convicted-of-raping-son-years-ago-cms-41753>

<http://www.digitaljournal.com/article/294597>

<http://cnews.canoe.com/CNEWS/Crime/2014/08/05/21854361.html>

<http://www.politicsforum.org/forum/viewtopic.php?t=121028>

<http://www.complex.com/pop-culture/2012/08/orange-county-mother-convicted-for-crossing-line-with-sons-friend>

<http://www.usatoday.com/story/sports/nfl/2015/08/21/molly-shattuck-ravens-cheerleader-sentenced-rape-boy/32108039/>

Newton 's Law of Cooling by Prof. Subhashish Chattopadhyay SKMClasses Bangalore Useful for IIT-JEE, CBSE, I.Sc. PU-II, Boards, CET, CEE, PET, IGCSE IB AP-Physics and other exams

POLICE: DELCO MOM HAD SEX WITH SON'S TEEN FRIEND

Police: Delco mom had sex with son's teen friend
none

 Share  G+1  Tweet

February 23, 2012 6:58:14 AM PST

Action News

UPPER CHICHESTER, Pa. - February 22, 2012 -- A Delaware County mother, accused of having sex with her son's 15-year-old friend, is out of jail and awaiting an arraignment.

A judge has agreed to place 34-year-old Teri Mezzatesta on an electronic monitoring system so she can take care of her disabled grandmother at her Upper Chichester home.

Mezzatesta faces charges of statutory sexual assault, a second-degree felony, and false swearing in official matters by falsely incriminating another.

Mezzatesta claims she was sexually assaulted.

Mezzatesta was arrested on January 27 after, according to the affidavit, her son went to school officials about what he allegedly saw on the night of November 15.

In the affidavit, the 14-year-old son tells police he witnessed his mother having sexual intercourse with his 15-year-old friend who was

<http://6abc.com/archive/8554005/>

<http://bossip.com/920633/hide-ya-kids-cali-mom-sentenced-6-years-in-prison-for-sexing-sons-12-year-old-friend-43081/>

<http://wncn.com/2016/07/02/ga-mom-sentenced-after-teen-naked-twister-party-with-sex-and-drugs/>

<http://www.chron.com/news/houston-texas/houston/article/Mother-who-supplied-drugs-in-prom-death-pleads-7431853.php>

http://www.starherald.com/news/local_news/sidney-mom-sentenced-in-molestation-of-son/article_09b03185-47a1-51a2-a6b6-98adc270d8ed.html

http://www.twcnews.com/archives/nys/central-ny/2007/12/14/mom-sentenced-in-sex-abuse-case-NY_38392.old.html

<http://wtvr.com/2015/08/23/molly-shattuck-oldest-ravens-cheerleader-rapes-sons-15-year-old-friend/>

http://maddad0467.newsvine.com/_news/2011/10/07/8203176-mom-sentenced-for-threesome-with-sons-friends

<http://www.dispatch.com/content/stories/local/2012/09/05/mother-sentenced-for-raping-her-baby.html>

news24 archives

Breaking News. First.

Mom 'had sex with son'

2010-01-28 10:02

Omaha - A 41-year-old US woman is accused of having sex nightly with her teenage son when he was in seventh and eighth grades, officials said on Wednesday.

Omaha Police said the now 15-year-old boy reported the alleged abuse last week to a counsellor, who notified authorities. The boy told police his mother was addicted to prescription drugs when the alleged abuse took place in 2008 and 2009 while he lived with her in Omaha.

The woman, who lives in the state of Nebraska, was arrested on Monday, according to Officer Michael Pecha. She made an initial appearance on Wednesday in court and her bond was set at \$30 000.

The Associated Press is not identifying the woman to protect her son's identity as a possible victim of sexual assault.

The teen has a younger brother, but authorities do not suspect the younger boy suffered any abuse, Douglas County Attorney Don Kleine said.

The boy's father told Omaha television station WOWT this week that he had previously had a feeling something was wrong, but didn't learn about the alleged abuse until a few weeks ago. He said his son is receiving counselling.

The woman will be represented by a public defender's office, but an attorney wasn't to be assigned to her case until Thursday. A preliminary hearing to discuss details of the charge against her was scheduled for February 8.

<http://www.news24.com/world/news/mom-had-sex-with-son-20100128>

<http://nypost.com/2016/04/09/mom-and-son-admit-to-incest-go-into-hiding-to-avoid-jail/>

<http://www.cbc.ca/news/canada/windsor/mom-gets-1-year-for-sex-with-foster-son-1.1121822>

<http://www.mcall.com/news/breaking/mc-allentown-verdict-woman-accused-molesting-boy-20160309-story.html>

http://www.nytimes.com/2015/10/25/magazine/the-strange-case-of-anna-stubblefield.html?_r=0

<http://www.norwalkreflector.com/Local/2015/09/21/Sex-offender-039-s-mom-talks-about-2009-juvenile-court-case>

<http://abcnews.go.com/US/hummer-mom-christine-hubbs-force-sex-teen-boys/story?id=13541399>

OC mom had sex with son's underage teammates,

by AP September 20 2011

SHARE



A 44-year-old Orange County woman had sex with at least two boys on her son's hockey team, investigators say. Both team members were under 18.

Orange County sheriff's spokesman Jim Amormino says one of the boys is under 16 years old and the other is under 14.

Amormino tells a local wire service that Kathia Maria Davis of Laguna Niguel was arrested last week and she was booked for investigation of unlawful sex and lewd acts with a minor. She was released after posting \$25,000 bail.

Davis was initially suspected of having sex with one boy. Amormino said Monday that a second boy has now surfaced and there may be a third.

<http://www.scpr.org/news/2011/09/19/28941/oc-mom-had-sex-sons-underage-teammates-authorities/>

<http://gasmicgore.com/forum/archive/index.php/t-3786.html>

http://lancasteronline.com/news/mom-sentenced-for-prostituting-son/article_d035429a-9354-5d37-8d17-0815efd0a3c2.html

<http://www.mercurynews.com/2009/12/15/north-carolina-mom-sentenced-for-putting-son-in-boiling-water/>

http://us.geosnews.com/p/us/oh/cuyahoga-county/cleveland/appellate-court-again-rules-mom-convicted-of-helping-son-in-madison-township-murder-should-get-new-trial_4970914

<https://www.propublica.org/article/false-rape-accusations-an-unbelievable-story>

<http://world.sports--news.com/news/lacey-spears-a-mother-accused>

<http://archive.decatordaily.com/decatordaily/news/070621/mom.shtml>

<http://www.tdcaa.com/node/3056>

<http://www.pravdareport.com/news/world/americas/04-11-2005/69955-0/>

Idaho mom had sex with son's friends

POSTREPLY ↩

Search this topic...

Search

[View latest posts](#) • [View unanswered posts](#) • [View unread posts](#) • [View new posts](#) • [View active](#)

Idaho mom had sex with son's friends

□ by **Abcshanghai** » Sat Jan 05, 2013 3:16 pm

http://www.cbsnews.com/2300-504083_162-10014846.html

I don't know about you guys but when was 15 I wanted to bang everything that moves.

Come to think about it I still want to bang everything that moves, but it still has to pass the ugly meter unless I'm drunk.

I don't feel the 15 year old boys are the victims. Its like branging rights. Hey I banged your mom, no seriously I literally banged your mom.

The victim is the mother in jail and her son having to live with out his mother and being stigmatized by his mother in jail.

The boys with so much testosterone in them thats what they do.

What's the big deal? Its most boys fantasy to have sex with an older women.

I remember in 6th grade my teachers name was Mrs. Rucker and oh boy did I want to...we'll you know. and she had a big old rack.

<http://www.shanghaiexpat.com/phpbbforum/idaho-mom-had-sex-with-son-s-friends-t151005.html>

<http://www.newsgrio.com/articles/248052-mom-drunkenly-let-a-convicted-sex-offender-who-exposed-himself-to-girls-under-13-give-her-three-children-permanent-tattoos.html>

<https://traffickalerts.wordpress.com/2015/01/15/incest-mom-sentenced-to-219-year-in-prison-over-alabama-sex-ring/>

<http://www.dailymail.co.uk/femail/article-2081674/Poppy-Burge-gets-liposuction-voucher-Human-Barbie-mum-Sarah-Christmas.html>

<http://www.nydailynews.com/news/national/florida-mom-charged-setting-fight-daughter-amp-classmate-article-1.1012931#ixzz1kx3LwRVQ>

<https://uk.style.yahoo.com/blogs/yahoo-lifestyles/mother-gives-botox-injections-her-eight-old-daughter-184941192.html>

To recall standard integrals

$f(x)$	$\int f(x)dx$	$f(x)$	$\int f(x)dx$
x^n	$\frac{x^{n+1}}{n+1} \quad (n \neq -1)$	$[g(x)]^n g'(x)$	$\frac{[g(x)]^{n+1}}{n+1} \quad (n \neq -1)$
$\frac{1}{x}$	$\ln x $	$\frac{g'(x)}{g(x)}$	$\ln g(x) $
e^x	e^x	a^x	$\frac{a^x}{\ln a} \quad (a > 0)$
$\sin x$	$-\cos x$	$\sinh x$	$\cosh x$
$\cos x$	$\sin x$	$\cosh x$	$\sinh x$
$\tan x$	$-\ln \cos x $	$\tanh x$	$\ln \cosh x$
$\operatorname{cosec} x$	$\ln \tan \frac{x}{2} $	$\operatorname{cosech} x$	$\ln \tanh \frac{x}{2} $
$\sec x$	$\ln \sec x + \tan x $	$\operatorname{sech} x$	$2 \tan^{-1} e^x$
$\sec^2 x$	$\tan x$	$\operatorname{sech}^2 x$	$\tanh x$
$\cot x$	$\ln \sin x $	$\operatorname{coth} x$	$\ln \sinh x $
$\sin^2 x$	$\frac{x}{2} - \frac{\sin 2x}{4}$	$\sinh^2 x$	$\frac{\sinh 2x}{4} - \frac{x}{2}$
$\cos^2 x$	$\frac{x}{2} + \frac{\sin 2x}{4}$	$\cosh^2 x$	$\frac{\sinh 2x}{4} + \frac{x}{2}$

$f(x)$	$\int f(x) dx$	$f(x)$	$\int f(x) dx$
$\frac{1}{a^2+x^2}$	$\frac{1}{a} \tan^{-1} \frac{x}{a}$ $(a > 0)$	$\frac{1}{a^2-x^2}$	$\frac{1}{2a} \ln \left \frac{a+x}{a-x} \right \quad (0 < x < a)$ $\frac{1}{2a} \ln \left \frac{x-a}{x+a} \right \quad (x > a > 0)$
$\frac{1}{\sqrt{a^2-x^2}}$	$\sin^{-1} \frac{x}{a}$ $(-a < x < a)$	$\frac{1}{\sqrt{a^2+x^2}}$	$\ln \left \frac{x+\sqrt{a^2+x^2}}{a} \right \quad (a > 0)$ $\ln \left \frac{x+\sqrt{x^2-a^2}}{a} \right \quad (x > a > 0)$
$\sqrt{a^2-x^2}$	$\frac{a^2}{2} \left[\sin^{-1} \left(\frac{x}{a} \right) + \frac{x\sqrt{a^2-x^2}}{a^2} \right]$	$\sqrt{a^2+x^2}$	$\frac{a^2}{2} \left[\sinh^{-1} \left(\frac{x}{a} \right) + \frac{x\sqrt{a^2+x^2}}{a^2} \right]$ $\frac{a^2}{2} \left[-\cosh^{-1} \left(\frac{x}{a} \right) + \frac{x\sqrt{x^2-a^2}}{a^2} \right]$

Some series Expansions -

$$\frac{\pi}{2} = \left(\frac{2}{1} \frac{2}{3}\right) \left(\frac{4}{3} \frac{4}{5}\right) \left(\frac{6}{5} \frac{6}{7}\right) \left(\frac{8}{7} \frac{8}{9}\right) \dots$$

$$\pi = \frac{4}{1} - \frac{4}{3} + \frac{4}{5} - \frac{4}{7} + \frac{4}{9} - \frac{4}{11} + \frac{4}{13} - \dots$$

$$\frac{\pi}{4} = \frac{1}{1} - \frac{1}{3} + \frac{1}{5} - \frac{1}{7} + \frac{1}{9} - \dots$$

$$\pi = \sqrt{12} \left(1 - \frac{1}{3 \cdot 3} + \frac{1}{5 \cdot 3^2} - \frac{1}{7 \cdot 3^3} + \dots\right)$$

$$\frac{\pi^2}{6} = \frac{1}{1^2} + \frac{1}{2^2} + \frac{1}{3^2} + \frac{1}{4^2} + \dots = \sum_{n=1}^{\infty} \frac{1}{n^2}$$

$$\int_0^{\pi/2} \log \sin x \, dx = -\frac{\pi}{2} \log 2 = \frac{\pi}{2} \log \frac{1}{2}$$

Solve a series problem

If $\frac{1}{1^2} + \frac{1}{2^2} + \frac{1}{3^2} + \dots$ upto $\infty = \frac{\pi^2}{6}$, then value of

$\frac{1}{1^2} + \frac{1}{3^2} + \frac{1}{5^2} + \dots$ up to ∞ is

- (a) $\frac{\pi^2}{4}$ (b) $\frac{\pi^2}{6}$ (c) $\frac{\pi^2}{8}$ (d) $\frac{\pi^2}{12}$

Ans. (c)

Solution We have $\frac{1}{1^2} + \frac{1}{3^2} + \frac{1}{5^2} + \dots$ upto ∞

$$= \frac{1}{1^2} + \frac{1}{2^2} + \frac{1}{3^2} + \frac{1}{4^2} + \frac{1}{5^2} + \frac{1}{6^2} + \dots \text{ upto } \infty$$

$$- \frac{1}{2^2} \left[1 + \frac{1}{2^2} + \frac{1}{3^2} + \dots\right]$$

$$= \frac{\pi^2}{6} - \frac{1}{4} \left(\frac{\pi^2}{6}\right) = \frac{\pi^2}{8}$$

$$1 - \frac{1}{2^2} + \frac{1}{3^2} - \frac{1}{4^2} + \frac{1}{5^2} - \frac{1}{6^2} + \dots \text{ upto } \infty = \frac{\pi^2}{12}$$

$$\frac{1}{2^2} + \frac{1}{4^2} + \frac{1}{6^2} + \dots \text{ upto } \infty = \frac{\pi^2}{24}$$

Newton 's Law of Cooling by Prof. Subhashish Chattopadhyay SKMClasses Bangalore Useful for IIT-JEE, CBSE, I.Sc. PU-II, Boards, CET, CEE, PET, IGCSE IB AP-Physics and other exams

$$\frac{\sin \sqrt{x}}{\sqrt{x}} = 1 - \frac{x}{3!} + \frac{x^2}{5!} - \frac{x^3}{7!} + \frac{x^4}{9!} - \frac{x^5}{11!} + \dots$$

$$\cos x = 1 - \frac{x^2}{2!} + \frac{x^4}{4!} - \dots = \sum_{k=0}^n \frac{(-1)^k x^{2k}}{(2k)!}$$

$$\sin x = x - \frac{x^3}{3!} + \frac{x^5}{5!} - \dots = \sum_{k=0}^n \frac{(-1)^k x^{2k+1}}{(2k+1)!}$$

$$\cosh x = 1 + \frac{x^2}{2!} + \frac{x^4}{4!} + \dots = \sum_{k=0}^n \frac{x^{2k}}{(2k)!}$$

$$\sinh x = x + \frac{x^3}{3!} + \frac{x^5}{5!} + \dots = \sum_{k=0}^n \frac{x^{2k+1}}{(2k+1)!}$$

$$\tan^{-1} x = x - \frac{x^3}{3} + \frac{x^5}{5} - \frac{x^7}{7} + \dots \quad (-1 \leq x < 1)$$

$$\tan x = x + \frac{x^3}{3} + \frac{2x^5}{15} + \frac{17x^7}{315} + \frac{62x^9}{2835} + \dots + \frac{2^{2n} (2^{2n} - 1) B_n x^{2n-1}}{(2n)!} + \dots \quad |x| < \frac{\pi}{2}$$

$$\sec x = 1 + \frac{x^2}{2} + \frac{5x^4}{24} + \frac{61x^6}{720} + \dots + \frac{E_n x^{2n}}{(2n)!} + \dots \quad |x| < \frac{\pi}{2}$$

$$\csc x = \frac{1}{x} + \frac{x}{6} + \frac{7x^3}{360} + \frac{31x^5}{15120} + \dots + \frac{2(2^{2n-1} - 1) B_n x^{2n-1}}{(2n)!} + \dots \quad 0 < |x| < \pi$$

$$\cot x = \frac{1}{x} - \frac{x}{3} + \frac{x^3}{45} - \frac{2x^5}{945} - \dots - \frac{2^{2n} B_n x^{2n-1}}{(2n)!} - \dots \quad 0 < |x| < \pi$$

Newton 's Law of Cooling by Prof. Subhashish Chattopadhyay SKMClasses Bangalore Useful for IIT-JEE, CBSE, I.Sc. PU-II, Boards, CET, CEE, PET, IGCSE IB AP-Physics and other exams

Newton's Law of Cooling by Prof. Subhashish Chattopadhyay SKMClasses Bangalore Useful for IIT-JEE, CBSE, I.Sc. PU-II, Boards, CET, CEE, PET, IGCSE IB AP-Physics and other exams

$$\tan x = x + \frac{x^3}{3} + \frac{2x^5}{15} + \dots$$

$$\sec x = 1 + \frac{x^2}{2} + \frac{5x^4}{4} + \dots$$

$$\log(\cos x) = -\frac{x^2}{2} - \frac{2x^4}{4} - \dots$$

$$\log(1 + \sin x) = x - \frac{x^2}{2} + \frac{x^3}{6} - \frac{x^4}{12} + \dots$$

$$\sin^{-1} x = x + \frac{1}{2} \frac{x^3}{3} + \frac{1 \cdot 3}{2 \cdot 4} \frac{x^5}{5} + \frac{1 \cdot 3 \cdot 5}{2 \cdot 4 \cdot 6} \frac{x^7}{7} + \dots \quad |x| < 1$$

$$\cos^{-1} x = \frac{\pi}{2} - \sin^{-1} x$$

$$= \frac{\pi}{2} - \left(x + \frac{1}{2} \frac{x^3}{3} + \frac{1 \cdot 3}{2 \cdot 4} \frac{x^5}{5} + \frac{1 \cdot 3 \cdot 5}{2 \cdot 4 \cdot 6} \frac{x^7}{7} + \dots \right) \quad |x| < 1$$

$$\tan^{-1} x = \begin{cases} x - \frac{x^3}{3} + \frac{x^5}{5} - \frac{x^7}{7} + \dots & |x| < 1 \\ \pm \frac{\pi}{2} - \frac{1}{x} + \frac{1}{3x^3} - \frac{1}{5x^5} + \dots & \begin{cases} + \text{ if } x \geq 1 \\ - \text{ if } x \leq -1 \end{cases} \end{cases}$$

$$\sec^{-1} x = \cos^{-1} \left(\frac{1}{x} \right)$$

$$= \frac{\pi}{2} - \left(\frac{1}{x} + \frac{1}{2 \cdot 3x^3} + \frac{1 \cdot 3}{2 \cdot 4 \cdot 5x^5} + \frac{1 \cdot 3 \cdot 5}{2 \cdot 4 \cdot 6 \cdot 7x^7} + \dots \right) \quad |x| > 1$$

$$\csc^{-1} x = \sin^{-1}(1/x)$$

$$= \frac{1}{x} + \frac{1}{2 \cdot 3x^3} + \frac{1 \cdot 3}{2 \cdot 4 \cdot 5x^5} + \frac{1 \cdot 3 \cdot 5}{2 \cdot 4 \cdot 6 \cdot 7x^7} + \dots \quad |x| > 1$$

$$\cot^{-1} x = \frac{\pi}{2} - \tan^{-1} x$$

$$= \begin{cases} \frac{\pi}{2} - \left(x - \frac{x^3}{3} + \frac{x^5}{5} - \frac{x^7}{7} + \dots \right) & |x| < 1 \end{cases}$$

$$\begin{cases} p\pi + \frac{1}{x} - \frac{1}{3x^3} + \frac{1}{5x^5} + \dots & \begin{cases} p = 0 \text{ if } x \geq 1 \\ p = 1 \text{ if } x \leq -1 \end{cases} \end{cases}$$

Newton's Law of Cooling by Prof. Subhashish Chattopadhyay SKMClasses Bangalore Useful for IIT-JEE, CBSE, I.Sc. PU-II, Boards, CET, CEE, PET, IGCSE IB AP-Physics and other exams

Newton's Law of Cooling by Prof. Subhashish Chattopadhyay SKMClasses Bangalore Useful for IIT-JEE, CBSE, I.Sc. PU-II, Boards, CET, CEE, PET, IGCSE IB AP-Physics and other exams

$$e^x = 1 + \frac{x}{1!} + \frac{x^2}{2!} + \frac{x^3}{3!} + \dots = \sum_{n=0}^{\infty} \frac{x^n}{n!}$$

$$\ln x = 2 \left[\frac{x-1}{x+1} + \frac{1}{3} \left(\frac{x-1}{x+1} \right)^3 + \frac{1}{5} \left(\frac{x-1}{x+1} \right)^5 + \dots \right]$$

$$= 2 \sum_{n=1}^{\infty} \frac{1}{2n-1} \left(\frac{x-1}{x+1} \right)^{2n-1} \quad (x > 0)$$

$$\ln x = \frac{x-1}{x} + \frac{1}{2} \left(\frac{x-1}{x} \right)^2 + \frac{1}{3} \left(\frac{x-1}{x} \right)^3 + \dots$$

$$= \sum_{n=1}^{\infty} \frac{1}{n} \left(\frac{x-1}{x} \right)^n \quad (x > \frac{1}{2})$$

$$\ln x = (x-1) - \frac{1}{2}(x-1)^2 + \frac{1}{3}(x-1)^3 - \dots$$

$$= \sum_{n=1}^{\infty} (-1)^{n-1} \frac{1}{n} (x-1)^n \quad (0 < x \leq 2)$$

$$\ln(1+x) = x - \frac{1}{2}x^2 + \frac{1}{3}x^3 - \dots$$

$$= \sum_{n=1}^{\infty} (-1)^{n-1} \frac{1}{n} x^n \quad (|x| < 1)$$

$$\log_e(1-x) = -x - \frac{x^2}{2} - \frac{x^3}{3} - \frac{x^4}{4} - \dots \infty \quad (-1 \leq x < 1)$$

$$\log_e(1+x) - \log_e(1-x) =$$

$$\log_e \frac{1+x}{1-x} = 2 \left(x + \frac{x^3}{3} + \frac{x^5}{5} + \dots \infty \right) \quad (-1 < x < 1)$$

$$\log_e \left(1 + \frac{1}{n} \right) = \log_e \frac{n+1}{n} = 2 \left[\frac{1}{2n+1} + \frac{1}{3(2n+1)^3} + \frac{1}{5(2n+1)^5} + \dots \infty \right]$$

$$\log_e(1+x) + \log_e(1-x) = \log_e(1-x^2) = -2 \left(\frac{x^2}{2} + \frac{x^4}{4} + \dots \infty \right) \quad (-1 < x < 1)$$

$$\log 2 = 1 - \frac{1}{2} + \frac{1}{3} - \frac{1}{4} + \frac{1}{5} - \dots = \frac{1}{1.2} + \frac{1}{3.4} + \frac{1}{5.6} + \dots$$

Newton's Law of Cooling by Prof. Subhashish Chattopadhyay SKMClasses Bangalore Useful for IIT-JEE, CBSE, I.Sc. PU-II, Boards, CET, CEE, PET, IGCSE IB AP-Physics and other exams

Important Results

(i) (a) $\int_0^{\pi/2} \frac{\sin^n x}{\sin^n x + \cos^n x} dx = \frac{\pi}{4} = \int_0^{\pi/2} \frac{\cos^n x}{\sin^n x + \cos^n x} dx$

(b) $\int_0^{\pi/2} \frac{\tan^n x}{1 + \tan^n x} dx = \frac{\pi}{4} = \int_0^{\pi/2} \frac{dx}{1 + \tan^n x}$

(c) $\int_0^{\pi/2} \frac{dx}{1 + \cot^n x} = \frac{\pi}{4} = \int_0^{\pi/2} \frac{\cot^n x}{1 + \cot^n x} dx$

(d) $\int_0^{\pi/2} \frac{\tan^n x}{\tan^n x + \cot^n x} dx = \frac{\pi}{4} = \int_0^{\pi/2} \frac{\cot^n x}{\tan^n x + \cot^n x} dx$

(e) $\int_0^{\pi/2} \frac{\sec^n x}{\sec^n x + \operatorname{cosec}^n x} dx = \frac{\pi}{4} = \int_0^{\pi/2} \frac{\operatorname{cosec}^n x}{\sec^n x + \operatorname{cosec}^n x} dx$ where, $n \in R$

(ii) $\int_0^{\pi/2} \frac{a^{\sin^n x}}{a^{\sin^n x} + a^{\cos^n x}} dx = \int_0^{\pi/2} \frac{a^{\cos^n x}}{a^{\sin^n x} + a^{\cos^n x}} dx = \frac{\pi}{4}$

(iii) (a) $\int_0^{\pi/2} \log \sin x dx = \int_0^{\pi/2} \log \cos x dx = -\frac{\pi}{2} \log 2$

(b) $\int_0^{\pi/2} \log \tan x dx = \int_0^{\pi/2} \log \cot x dx = 0$

(c) $\int_0^{\pi/2} \log \sec x dx = \int_0^{\pi/2} \log \operatorname{cosec} x dx = \frac{\pi}{2} \log 2$

(iv) (a) $\int_0^{\infty} e^{-ax} \sin bx dx = \frac{b}{a^2 + b^2}$

(b) $\int_0^{\infty} e^{-ax} \cos bx dx = \frac{a}{a^2 + b^2}$

(c) $\int_0^{\infty} e^{-ax} x^n dx = \frac{n!}{a^{n+1}}$

Newton 's Law of Cooling by Prof. Subhashish Chattopadhyay SKMClasses Bangalore Useful for IIT-JEE, CBSE, I.Sc. PU-II, Boards, CET, CEE, PET, IGCSE IB AP-Physics and other exams

$$\int \frac{dx}{\sqrt{x^2 - a^2}} = \ln \left(x + \sqrt{x^2 - a^2} \right) + C$$

$$\int \frac{dx}{\sqrt{x^2 + a^2}} = \ln \left(x + \sqrt{x^2 + a^2} \right) + C$$

$$\int \frac{dx}{x^2 - a^2} = \frac{1}{2a} \ln \left(\frac{x-a}{x+a} \right) + C$$

$$\int \frac{dx}{a^2 - x^2} = \frac{1}{2a} \ln \left(\frac{a+x}{a-x} \right) + C$$

$$\int \sqrt{a^2 - x^2} dx = \frac{x}{2} \sqrt{a^2 - x^2} + \frac{a^2}{2} \sin^{-1} \left(\frac{x}{a} \right) + C$$

$$\int \sqrt{a^2 + x^2} dx = \frac{x}{2} \sqrt{a^2 + x^2} + \frac{a^2}{2} \sinh^{-1} \left(\frac{x}{a} \right) + C$$

$$\int \sqrt{x^2 - a^2} dx = \frac{x}{2} \sqrt{x^2 - a^2} - \frac{a^2}{2} \cosh^{-1} \left(\frac{x}{a} \right) + C$$

Plato and many others, since long told something about Truth ...

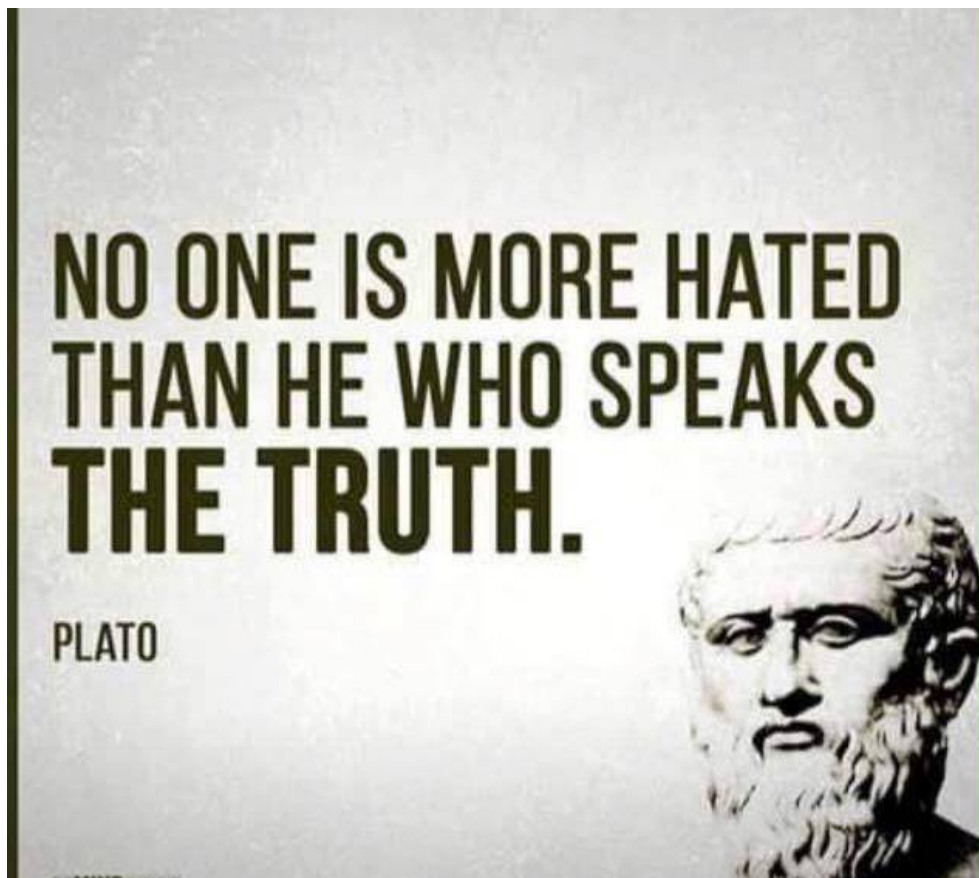

So I "lied" on a few things in this Book ! :-{D

Newton 's Law of Cooling by Prof. Subhashish Chattopadhyay SKMClasses Bangalore Useful for IIT-JEE, CBSE, I.Sc. PU-II, Boards, CET, CEE, PET, IGCSE IB AP-Physics and other exams

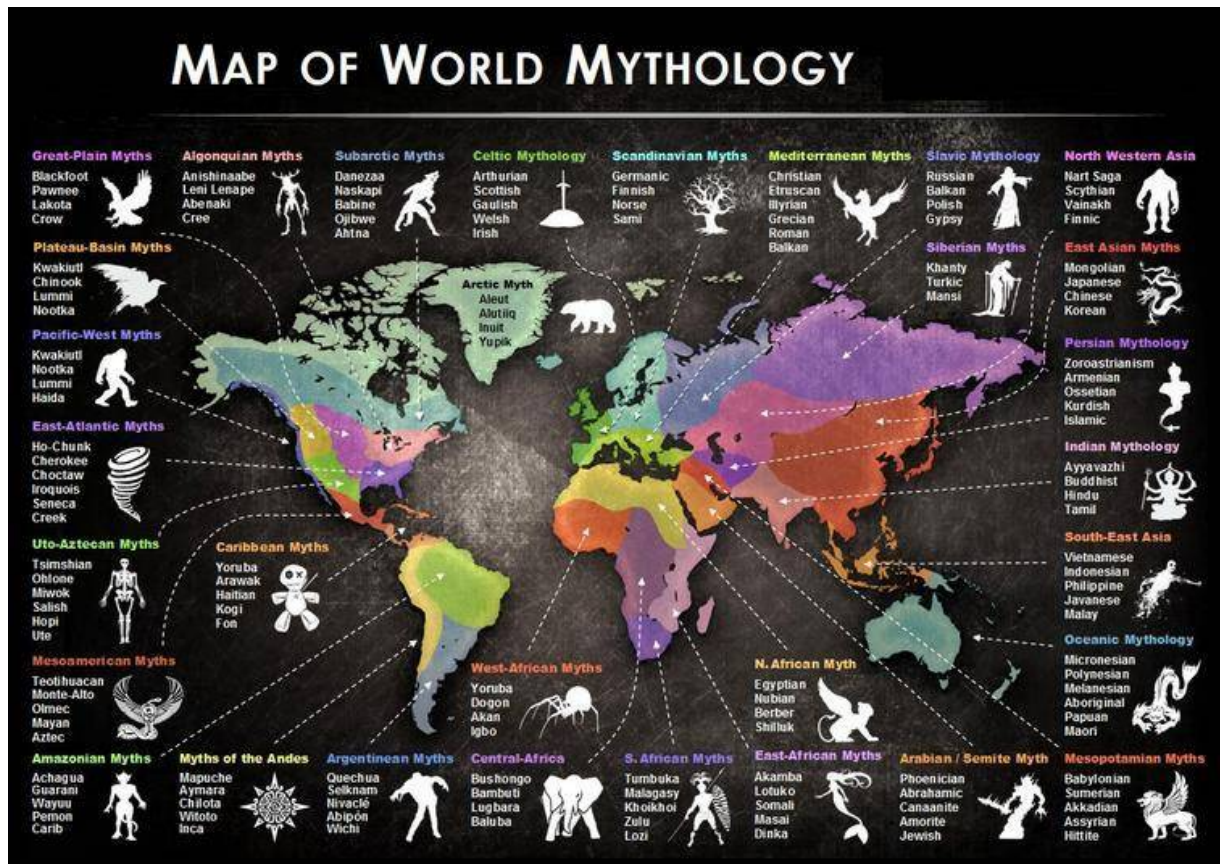

Given: $a = b$

$$a^2 = ab$$

$$a^2 - b^2 = ab - b^2$$

$$(a+b)(a-b) = b(a-b)$$

$$(a+b) = b$$

$$a+a = a$$

$$2a = a$$

$$2 = 1 !!!$$

$$-20 = -20$$

$$16 - 36 = 25 - 45$$

$$4^2 - (4)(9) = 5^2 - (5)(9)$$

$$4^2 - (4)(9) + \frac{81}{4} = 5^2 - (5)(9) + \frac{81}{4}$$

$$4^2 - 2(4)\left(\frac{9}{2}\right) + \left(\frac{9}{2}\right)^2 = 5^2 - 2(5)\left(\frac{9}{2}\right) + \left(\frac{9}{2}\right)^2$$

$$\left(4 - \frac{9}{2}\right)^2 = \left(5 - \frac{9}{2}\right)^2$$

$$4 - \frac{9}{2} = 5 - \frac{9}{2}$$

$$4 = 5$$

$$4 - 4 = 5 - 4$$

$$0 = 1$$



"Logic of Religion and Mythology" is like above ...

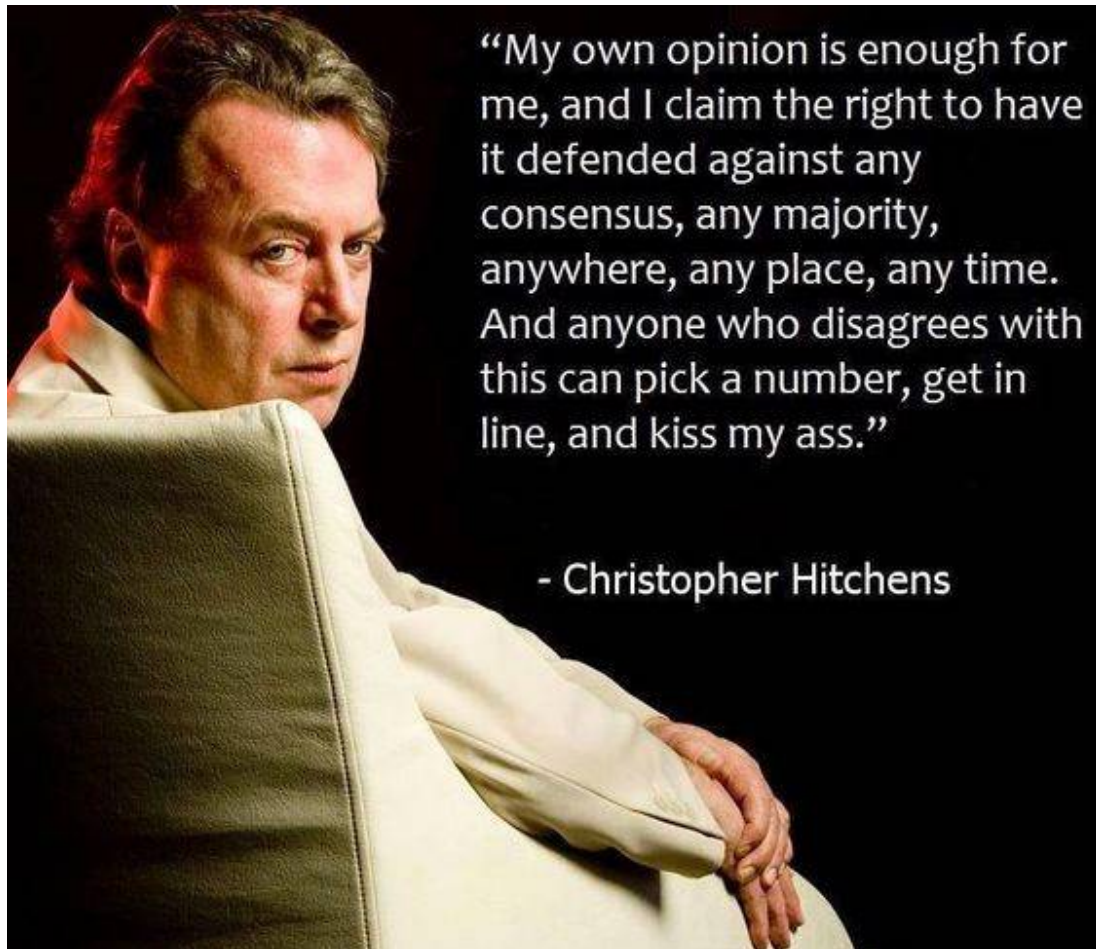

(Some people may agree that I am much more Polite, than Christopher Hitchens ... May be I achieved much lesser because of that!)

Newton 's Law of Cooling by Prof. Subhashish Chattopadhyay SKMClasses Bangalore Useful for IIT-JEE, CBSE, I.Sc. PU-II, Boards, CET, CEE, PET, IGCSE IB AP-Physics and other exams



(In 2016 Celebrating 27 years of Excellence in Teaching)

Good Luck to you for your Preparations, References, and Exams

All Other Books written by me can be downloaded from

<https://zookeepersblog.wordpress.com/free-pdf-e-book-download-for-iit-jee-cbse-isc-cet-physics-chemistry-maths-from-professor-subhashish-skmclasses/>

Professor [Subhashish Chattopadhyay](#)

[Learn more](#) at <http://skmclasses.weebly.com/iit-je-home-tuitions-bangalore.html>

[Twitter](#) - <https://twitter.com/ZookeeperPhy>

[Facebook](#) - <https://www.facebook.com/IIT.JEE.by.Prof.Subhashish/>

[Blog](#) - <http://skmclasses.kinja.com>

Newton 's Law of Cooling by Prof. Subhashish Chattopadhyay SKMClasses Bangalore Useful for IIT-JEE, CBSE, I.Sc. PU-II, Boards, CET, CEE, PET, IGCSE IB AP-Physics and other exams