

Gravitation by Prof. Subhashish Chattopadhyay SKMClasses Bangalore Useful for IIT-JEE, CBSE, I.Sc. PU-II, Boards, CET, CEE, PET, IGCSE IB AP-Physics and other exams



### Spoon Feeding Gravitation Physics



### Simplified Knowledge Management Classes Bangalore

My name is [Subhashish Chattopadhyay](#). I have been teaching for IIT-JEE, Various International Exams ( such as IMO [ International Mathematics Olympiad ], IPhO [ International Physics Olympiad ], IChO [ International Chemistry Olympiad ] ), IGCSE ( IB ), CBSE, I.Sc, Indian State Board exams such as WB-Board, Karnataka PU-II etc since 1989. As I write this book in 2016, it is my 27 th year of teaching. I was a Visiting Professor to BARC Mankhurd, Chembur, Mumbai, Homi Bhabha Centre for Science Education ( HBCSE ) Physics Olympics camp BARC Campus.

Gravitation by Prof. Subhashish Chattopadhyay SKMClasses Bangalore Useful for IIT-JEE, CBSE, I.Sc. PU-II, Boards, CET, CEE, PET, IGCSE IB AP-Physics and other exams

Gravitation by Prof. Subhashish Chattopadhyay SKMClasses Bangalore Useful for IIT-JEE, CBSE, I.Sc. PU-II, Boards, CET, CEE, PET, IGCSE IB AP-Physics and other exams

I am Life Member of ...

- [IAPT \( Indian Association of Physics Teachers \)](#)
- [IPA \( Indian Physics Association \)](#)
- [AMTI \( Association of Mathematics Teachers of India \)](#)
- [National Human Rights Association](#)
- [Men's Rights Movement \( India and International \)](#)
- [MGTOW Movement \( India and International \)](#)

And also of

[IACT \( Indian Association of Chemistry Teachers \)](#)



**The selection for National Camp ( for Official Science Olympiads - Physics, Chemistry, Biology, Astronomy ) happens in the following steps ....**

1 ) **NSEP** ( National Standard Exam in Physics ) and **NSEC** ( National Standard Exam in Chemistry ) held around 24 rth November. Approx 35,000 students appear for these exams every year. The exam fees is Rs 100 each. Since 1998 the IIT JEE toppers have been topping these exams and they get to know their rank / performance ahead of others.

2 ) **INPhO** ( Indian National Physics Olympiad ) and **INChO** ( Indian National Chemistry Olympiad ). Around 300 students in each subject are allowed to take these exams. Students coming from outside cities are paid fair from the Govt of India.

3 ) The Top 35 students of each subject are invited at HBCSE ( Homi Bhabha Center for Science Education ) Mankhurd, near Chembur, BARC, Mumbai. After a 2-3 weeks camp the top 5 are selected to represent India. The flight tickets and many other expenses are taken care by Govt of India.

Since last 50 years there has been no dearth of "Good Books". Those who are interested in studies have been always doing well. This e-Book does not intend to replace any standard text book. These topics are very old and already standardized.

Gravitation by Prof. Subhashish Chattopadhyay SKMClasses Bangalore Useful for IIT-JEE, CBSE, I.Sc. PU-II, Boards, CET, CEE, PET, IGCSE IB AP-Physics and other exams

Gravitation by Prof. Subhashish Chattopadhyay SKMClasses Bangalore Useful for IIT-JEE, CBSE, I.Sc. PU-II, Boards, CET, CEE, PET, IGCSE IB AP-Physics and other exams

### **There are 3 kinds of Text Books**

- The thin Books - Good students who want more details are not happy with these. Average students who need more examples are not happy with these. Most students who want to "Cram" quickly and pass somehow find the thin books "good" as they have to read less !!

- **The Thick Books - Most students do not like these, as they want to read as less as possible. Average students are "busy" with many other things and have no time to read all these.**

- The Average sized Books - Good students do not get all details in any one book. Most bad students do not want to read books of "this much thickness" also !!

**We know there can be no shoe that's fits in all.**

Printed books are not e-Books! Can't be downloaded and kept in hard-disc for reading "later" .....

So if you read this book later, you will get all kinds of examples in a single place. This becomes a very good "Reference Material". I sincerely wish that all find this "very useful".



Students who do not practice lots of problems, do not do well. The rules of "doing well" had never changed .... Will never change !

Gravitation by Prof. Subhashish Chattopadhyay SKMClasses Bangalore Useful for IIT-JEE, CBSE, I.Sc. PU-II, Boards, CET, CEE, PET, IGCSE IB AP-Physics and other exams

Gravitation by Prof. Subhashish Chattopadhyay SKMClasses Bangalore Useful for IIT-JEE, CBSE, I.Sc. PU-II, Boards, CET, CEE, PET, IGCSE IB AP-Physics and other exams

After 2016 CBSE Mathematics exam, lots of students complained that the paper was tough!

Updated 8:47 am Mar 22, 2016

**IBNLive**  

ENGLISH HINDI MARATHI



READ WATCH CRICKET TECH

LATEST BUDGET 2016 POLITICS INDIA SPORTS FOOTBALL MOVIES LIVE TV BUZZ

IBNLIVE » INDIA

## CBSE assures remedial measures for tricky and tough Class XII Math paper

Posted on: 12:17 PM IST Mar 17, 2016 | Updated on: 12:20 pm, Mar 17, 2016 IST

IBNLIVE.COM    14 More+

After several students claimed that the Central Board of Secondary Education (CBSE) Class XII board Mathematics examination paper was 'tricky' and tough, the board has issued a clarification on remedial measures which are likely to be taken before evaluation.

The CBSE says that feedback received from various stakeholders like students, subject teachers and examiners will be put before the committee of subject experts.

close

Gravitation by Prof. Subhashish Chattopadhyay SKMClasses Bangalore Useful for IIT-JEE, CBSE, I.Sc. PU-II, Boards, CET, CEE, PET, IGCSE IB AP-Physics and other exams

On 21 st May 2016 the CBSE standard 12 result was declared. [I loved the headline](#)

INDIATODAY.IN NEW DELHI, MAY 21, 2016 | UPDATED 16:40 IST

## CBSE Class 12 Results out: No leniency in Maths paper, high paper standard to be maintained in future

The CBSE Class 12 Mathematics board exam on March 14 reduced many students to tears as they found the paper quite lengthy and tough and many couldn't finish it on time. The results show an overall lowering of marks received in the Maths paper.



### RELATED STORIES

- ❑ CBSE Board result 2016 declared! Thiruvananthpuram obtains the highest part percentage, check how your region scored
- ❑ Meet CBSE topper Sukriti Gupta: Check her percentage here!
- ❑ CBSE Class 12 Boards 2016: Results announced ahead of time!
- ❑ CBSE results declared at [www.cbse.nic.in](http://www.cbse.nic.in): Steps to check online
- ❑ Exclusive! CBSE declares Class 12 Results at [www.cbseresults.nic.in](http://www.cbseresults.nic.in) and [cbse.nic.in](http://cbse.nic.in)

The CBSE (Central Board of Secondary Education) Class 12 Board exam results have been announced today, i.e on May 21, around 10:30 am ahead of time. Students may check their scores at the official website, [www.cbseresults.nic.in](http://www.cbseresults.nic.in). (Read: **CBSE Class 12 Boards 2016: Results announced ahead of time! Check your score at [cbseresults.nic.in](http://cbseresults.nic.in)**)

Gravitation by Prof. Subhashish Chattopadhyay SKMClasses Bangalore Useful for IIT-JEE, CBSE, I.Sc. PU-II, Boards, CET, CEE, PET, IGCSE IB AP-Physics and other exams

In 2015 also the same complain was there by many students

The screenshot shows a news article on the Zee News website. The header includes the Zee News logo, language options (Hindi, Marathi, Kannada), and mobile app icons for Apple, Android, and Facebook. The navigation bar lists categories: INDIA, STATES, WORLD, S ASIA, BIZ, SPORTS, CRICKET, SCI-TECH, SHOWBIZ, HEALTH, BLOG, and EXCLUSIVE. The article title is "CBSE Class 12 exam: Issue of tough maths paper raised in Parliament". The sub-headline reads: "A senior Congress member on Thursday raised the issue of the tough mathematics question paper in the ongoing CBSE board examinations and asked the government to consider the issue 'seriously'". The article is dated "Last Updated: Thursday, March 19, 2015 - 14:41". It has 2547 shares (Facebook, Twitter, G+), 16 comments, and 33 comments. A "Follow @ZeeNews" button is also visible. The article text begins with "New Delhi: A senior Congress member on Thursday raised the issue of the tough mathematics question paper in the ongoing CBSE board examinations and asked the government to consider the issue 'seriously'".

So we see that by raising frivolous requests, even upto parliament, actually does not help. Many times requests from several quarters have been put to CBSE, or Parliament etc for easy Math Paper. These kinds of requests actually can-not be entertained, never will be.

Gravitation by Prof. Subhashish Chattopadhyay SKMClasses Bangalore Useful for IIT-JEE, CBSE, I.Sc. PU-II, Boards, CET, CEE, PET, IGCSE IB AP-Physics and other exams

Gravitation by Prof. Subhashish Chattopadhyay SKMClasses Bangalore Useful for IIT-JEE, CBSE, I.Sc. PU-II, Boards, CET, CEE, PET, IGCSE IB AP-Physics and other exams

In March 2016, students of Karnataka PU-II also complained the same, regarding standard 12 ( PU-II Mathematics Exam ). Even though the Math Paper was identical to previous year, most students had not even solved the 2015 Question Paper.

Friday, March 25, 2016 - 13:28

The **NEWS** Minute

HOME NEWS ANDHRA KARNATAKA KERALA TAMIL NADU TELANGANA CULTURE MEDIA BLOG

Exams

## Online petition for lenient evaluation of K'taka II PU math paper gets over 8000 supporters

The campaign, which was launched on Monday, has garnered over 8000 supporters

TNM Staff | Wednesday, March 16, 2016 - 09:32

[Follow @thenewsminute](#)

[Share](#) [Tweet](#) [Email](#) [Share](#) [Reddit](#)

Following a "very tough" math paper that left many II PU students in tears, Saket Ravindran a student launched an online campaign demanding lenient evaluation.

These complains are not new. In fact since last 40 years, ( since my childhood ), I always see this; every year the same setback, same complain!

In this e-Book I am trying to solve this problem. Those students who practice can learn.

**No one can help those who are not studying, or practicing.**

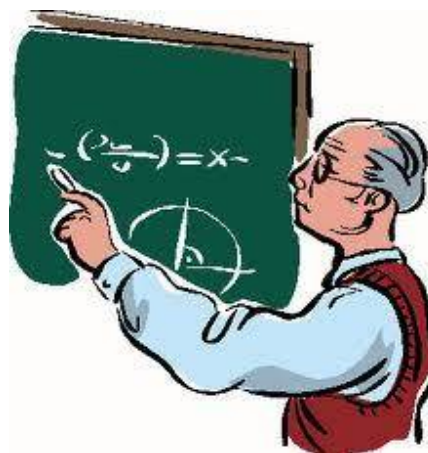

Gravitation by Prof. Subhashish Chattopadhyay SKMClasses Bangalore Useful for IIT-JEE, CBSE, I.Sc. PU-II, Boards, CET, CEE, PET, IGCSE IB AP-Physics and other exams

Gravitation by Prof. Subhashish Chattopadhyay SKMClasses Bangalore Useful for IIT-JEE, CBSE, I.Sc. PU-II, Boards, CET, CEE, PET, IGCSE IB AP-Physics and other exams

Learn more at <http://skmclasses.weebly.com/iit-jee-home-tuitions-bangalore.html>

Twitter - <https://twitter.com/ZookeeperPhy>

Facebook - <https://www.facebook.com/IIT.JEE.by.Prof.Subhashish/>

Blog - <http://skmclasses.kinja.com>

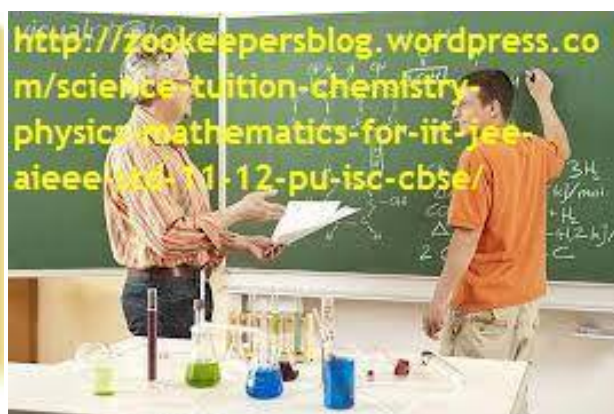

### A very polite request :

I wish these e-Books are read only by Boys and Men. Girls and Women, better read something else; learn from somewhere else.

Gravitation by Prof. Subhashish Chattopadhyay SKMClasses Bangalore Useful for IIT-JEE, CBSE, I.Sc. PU-II, Boards, CET, CEE, PET, IGCSE IB AP-Physics and other exams



### Preface

We all know that in the species "Homo Sapiens", males are bigger than females. The reasons are explained in standard 10, or 11 (high school) Biology texts. **This shapes or size, influences all of our culture.** Before we recall / understand the reasons once again, let us see some random examples of the influence

#### Random - 1

If there is a Road rage, then who all fight? (generally?). Imagine two cars driven by adult drivers. Each car has a woman of similar age as that of the Man. The cars "touch" or "some issue happens". Who all comes out and fights? Who all are most probable to drive the cars?



( Men are eager to fight, eager to rule, eager for war. Men want to drive. Men want to win )

#### Random - 2

Heavy metal music artists are all Men. Metallica, Black Sabbath, Motley Crue, Megadeth, Motorhead, AC/DC, Deep Purple, Slayer, Guns & Roses, Led Zeppelin, Aerosmith .... [the list can be in thousands](#). All these are grown-up Boys, known as Men.



( **Men strive for perfection. Men are eager to excel. Men work hard. Men want to win.** )



Gravitation by Prof. Subhashish Chattopadhyay SKMClasses Bangalore Useful for IIT-JEE, CBSE, I.Sc. PU-II, Boards, CET, CEE, PET, IGCSE IB AP-Physics and other exams

Random - 3

Apart from Marie Curie, only one more woman got Nobel Prize in Physics. ( Maria Goeppert Mayer - 1963 ). So, ... almost all are men.



( **Men want to excel. Men strive for perfection. Men want to win. Men work hard. Men do better than women.** )

Random - 4

The best Tabla Players are all Men.



( **Men want to excel. Men strive for perfection. Men want to win. Men work hard. Men do better than women.** )

Gravitation by Prof. Subhashish Chattopadhyay SKMClasses Bangalore Useful for IIT-JEE, CBSE, I.Sc. PU-II, Boards, CET, CEE, PET, IGCSE IB AP-Physics and other exams

Gravitation by Prof. Subhashish Chattopadhyay SKMClasses Bangalore Useful for IIT-JEE, CBSE, I.Sc. PU-II, Boards, CET, CEE, PET, IGCSE IB AP-Physics and other exams

Random - 5

History is all about, [which all Kings ruled](#). Kings, their men, and Soldiers went for wars. [History is all about wars, fights, and killings by men](#). Who won, and who controlled !



**Boys start fighting from school days. Girls do not fight like this**



( [Men are eager to fight, eager to rule, eager for war. Men want to drive. Men want to win.](#) )

Gravitation by Prof. Subhashish Chattopadhyay SKMClasses Bangalore Useful for IIT-JEE, CBSE, I.Sc. PU-II, Boards, CET, CEE, PET, IGCSE IB AP-Physics and other exams

Gravitation by Prof. Subhashish Chattopadhyay SKMClasses Bangalore Useful for IIT-JEE, CBSE, I.Sc. PU-II, Boards, CET, CEE, PET, IGCSE IB AP-Physics and other exams

Random - 6

The highest award in Mathematics, the " Fields Medal " is around since decades. Till date only one woman could get that. ( Maryam Mirzakhani - 2014 ). So, ... almost all are men.



( Men want to excel. Men strive for perfection. Men want to win. Men work hard. Men do better than women. )

Random - 7

Actor is a gender neutral word. Could the movie like " Top Gun " be made with Female actors ? The best pilots, astronauts, Fighters are all Men.



Gravitation by Prof. Subhashish Chattopadhyay SKMClasses Bangalore Useful for IIT-JEE, CBSE, I.Sc. PU-II, Boards, CET, CEE, PET, IGCSE IB AP-Physics and other exams

Gravitation by Prof. Subhashish Chattopadhyay SKMClasses Bangalore Useful for IIT-JEE, CBSE, I.Sc. PU-II, Boards, CET, CEE, PET, IGCSE IB AP-Physics and other exams

Random - 8

In my childhood had seen a movie named " The Tower in Inferno ". In the movie when the tall tower is in fire, women were being saved first, as only one lift was working....



Many decades later another movie is made. A box office hit. " The Titanic ". In this also .... As the ship is sinking women are being saved. Men are disposable. Men may get their turn later... ( never ) !!



Movies are not training programs. Movies do not teach people what to do, or not to do. Movies only reflect the prevalent culture. Men are disposable; is the culture in the society. Knowingly, unknowingly, the culture is depicted in Movies, Theaters, Stories, Poems, Rituals, etc. I or you can't write a story, or make a movie in which after a minor car accident the Male passengers keep seating in the back seat, while the both the women drivers come out of the car and start fighting very bitterly on the road. There has been no story in this world, or no movie made, where after an accident or calamity, Men are being helped for safety first, and women are told to wait.

Gravitation by Prof. Subhashish Chattopadhyay SKMClasses Bangalore Useful for IIT-JEE, CBSE, I.Sc. PU-II, Boards, CET, CEE, PET, IGCSE IB AP-Physics and other exams

Random - 9

Artists generally follow the prevalent culture of the Society. In paintings, sculptures, stories, poems, movies, cartoon, Caricatures, knowingly / unknowingly, " **the prevalent Reality** " is depicted. **The opposite will not go well with people**. If deliberately " the opposite " is shown then it may only become a special art, considered as a special mockery.

पत्नी (सल्लू से): मुझे नई साड़ी ला दो प्लीज।  
 सल्लू : पर तुम्हारी दो-दो अलमारियां साईं डियों से ही तो भरी हैं।  
 पत्नी - वह सारी तो पूरे मोहल्ले वालों ने देख रखी हैं।  
 सल्लू - तो साड़ी लेने के बजाए मोहल्ला बदल लेते हैं।



Random - 10

Men go to "girl / woman's house" to marry / win, and bring her to his home. That is a sort of winning her. When a boy gets a " Girl-Friend ", generally he and his friends consider that as an achievement. The boy who " got / won " a girl-friend feels proud. His male friends feel, jealous, competitive and envious. Millions of stories have been written on these themes. Lakhs of movies show this. Boys / Men go for " bike race ", or say " Car Race ", where the winner " gets " the most beautiful girl of the college.



( **Men want to excel. Men are eager to fight, eager to rule, eager for war. Men want to drive. Men want to win.** )

Prithviraj Chauhan ' **went** ' to " **pickup** " or " **abduct** " or " **win** " or " **bring** " his love. There was a Hindi movie ( hit ) song ... " **Pasand ho jaye, to ghar se utha laye** ". It is not other way round. Girls do not go to Boy's house or man's house to marry. Nor the girls go in a gang to " pick-up " the boy / man and bring him to their home / place / den.

Gravitation by Prof. Subhashish Chattopadhyay SKMClasses Bangalore Useful for IIT-JEE, CBSE, I.Sc. PU-II, Boards, CET, CEE, PET, IGCSE IB AP-Physics and other exams

Random - 11

We have the word "ice cold". While, when it snows heavily, the cleaning of the roads is done by Men. Ice avalanche is cleared by Guns, by Men.



Can women do this please ?



Random - 12



Gravitation by Prof. Subhashish Chattopadhyay SKMClasses Bangalore Useful for IIT-JEE, CBSE, I.Sc. PU-II, Boards, CET, CEE, PET, IGCSE IB AP-Physics and other exams

Gravitation by Prof. Subhashish Chattopadhyay SKMClasses Bangalore Useful for IIT-JEE, CBSE, I.Sc. PU-II, Boards, CET, CEE, PET, IGCSE IB AP-Physics and other exams



There are many remote mines in this world which are connected by rails through Hilly regions. These railroads move through steep ups and downs. Optimum speed of the train has to be maintained !! The expert driver has to ensure that the brakes do not burn out, if driven too slow. The speed should be enough so that next climbing can be done. Sudden braking is not possible ! ; as the load of the wagons will derail the train, and that will mean huge loss and deaths. The **Drivers are Men who risk their lives in every journey.**

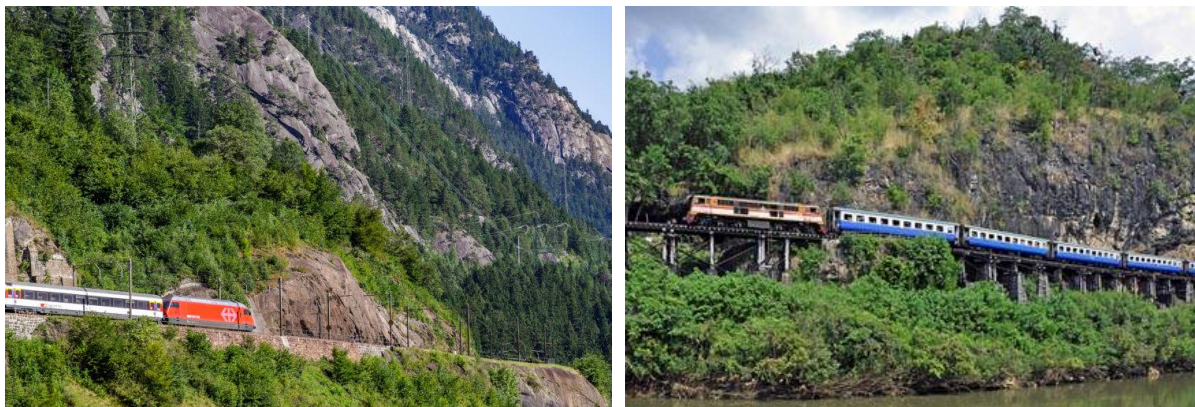

Gravitation by Prof. Subhashish Chattopadhyay SKMClasses Bangalore Useful for IIT-JEE, CBSE, I.Sc. PU-II, Boards, CET, CEE, PET, IGCSE IB AP-Physics and other exams



Gravitation by Prof. Subhashish Chattopadhyay SKMClasses Bangalore Useful for IIT-JEE, CBSE, I.Sc. PU-II, Boards, CET, CEE, PET, IGCSE IB AP-Physics and other exams



**Fukushima Daiichi nuclear disaster** happened on March 11, 2011. This was primarily by the tsunami following the Tōhoku earthquake ( magnitude 9.0 ). Lots of radioactive materials were scattered in the environment thorough “vent” to reduce the internal pressure and the hydroponic explosions of the nuclear reactors.

Old Men, Pensioners, Seniors offered to cleanup the Nuclear damage as '**suicide corps**' See <http://edition.cnn.com/2011/WORLD/asiapcf/05/31/japan.nuclear.suicide/>

## Old People Line Up To Clean Radiation in Japan



kelly  
5/31/11 10:00pm - Filed to: JAPAN



*I deeply appreciate such gesture to "Save" the society.* While I wish to draw your attention to a much deeper/important questions !!

**Why old women did not Volunteer to clean the Nuclear site ?**

Gravitation by Prof. Subhashish Chattopadhyay SKMClasses Bangalore Useful for IIT-JEE, CBSE, I.Sc. PU-II, Boards, CET, CEE, PET, IGCSE IB AP-Physics and other exams

Gravitation by Prof. Subhashish Chattopadhyay SKMClasses Bangalore Useful for IIT-JEE, CBSE, I.Sc. PU-II, Boards, CET, CEE, PET, IGCSE IB AP-Physics and other exams

**Old women are not pregnant !** Women get menopause sometime in their early 40s. Why is it so common in the Society to "Save" older women as well, and "spare" or "deprive" old men ?  
[Why old men are treated so badly ? Why are Men eager to fight every war ?](#)

[ Climbing Everest or any Mountain Peak, or say crossing Atlantic solo, or reaching the North Pole / South Pole; Almost ALL are Men isn't it .... Researching into technology, inventing and discovering new frontiers of Science is also a war! In every case it is [Almost ALL Men](#) ]

**Very Sad, [bad habit of Million years](#), is driving the world for so much of "Good" and "BAD" !**

The reader / student should not assume that I have not read enough Philosophy; where it is taught that GOOD or BAD are only individual's mental interpretations. I am mature enough to say the above words as .... ' Million years of Good Habit of ["Fighting to Win and Survive"](#) has led Men to all sorts of difficulties, accidents, discomforts, loss .... '

**Most women are just Thankless to Men, and their efforts. Women just use Men like parasite or Leeches. They see all the facilities' and benefits as their right !**

( Unfortunately most men submit themselves to be used / exploited like this ! MGTOW s are one of the exceptions. )

**In all countries the Laws / Traditions / Customs / Society norms etc have been systematically twisted in favor of women to ensure that Women get "everything". While Nothing is available for Men !**



**For example Money, Job, Certificate, Facilities etc are given to Widow and ( may be Mom ) of the deceased MAN; [who died 'fighting'](#) ! [The Law or norm](#) is not for the father of the Soldier. [ Think ... who is dying ? Who is surviving ? Who is getting the benefits ? who is being deprived ? ]**

( These images are a few amongst Millions of images which are available. All make the same point )

Gravitation by Prof. Subhashish Chattopadhyay SKMClasses Bangalore Useful for IIT-JEE, CBSE, I.Sc. PU-II, Boards, CET, CEE, PET, IGCSE IB AP-Physics and other exams

Home > India > India News > Paternity leave will be just a holiday for men, says Maneka Gandhi

# Paternity leave will be just a holiday for men, says Maneka Gandhi

The legislation would mean that India would join the ranks of Eastern European and Nordic countries that have the longest fully paid maternity leave.

88.8K  
SHARES



Written by **Shalini Nair** | New Delhi | Updated: August 25, 2016 10:50 am



Men are only for working ! ( sorry, hunting! ) always ... that's what most people think !

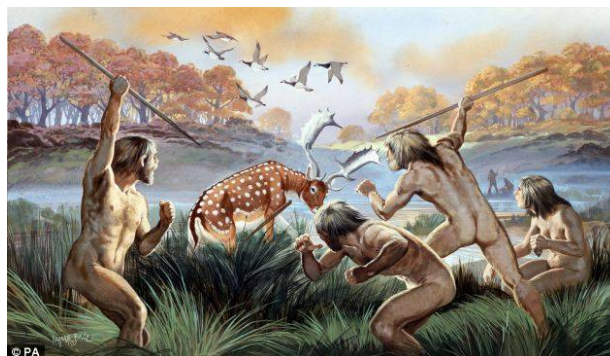
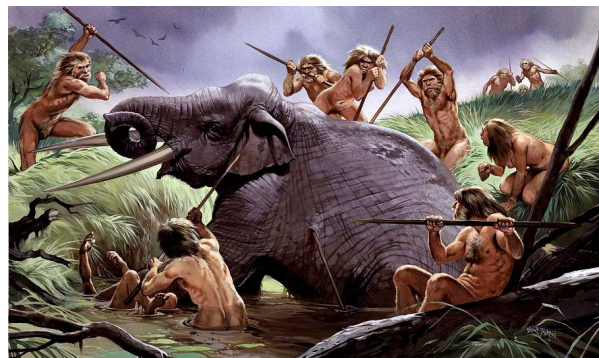
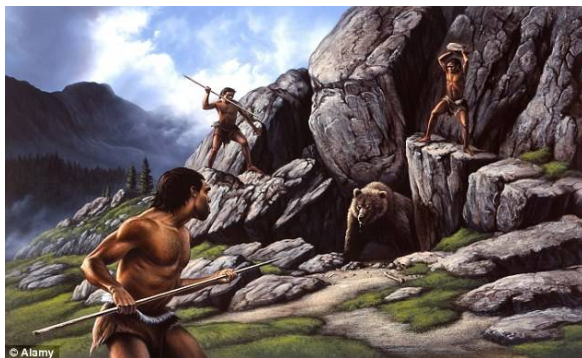

Gravitation by Prof. Subhashish Chattopadhyay SKMClasses Bangalore Useful for IIT-JEE, CBSE, I.Sc. PU-II, Boards, CET, CEE, PET, IGCSE IB AP-Physics and other exams



Every woman has a womb. The women ( rather their Wombs ) were protected / kept safe, so that children are born. That was the survival method to continue the species...

**Let us name the best of the Mathematicians ...**

Leonhard Euler, Isaac Newton, Carl Gauss, Fermat, Henri Poincaré, Lagrange, David Hilbert, G.W. Leibniz ...

( See <http://fabpedigree.com/james/mathmen.htm> )

**Why all these great names are of Men ? Why women could not contribute, in the cozy safe home ?**

A newly married couple goes out in car ... and if there is a flat tire ( known as puncture in India ) then who opens the wheels ? who replaces from the stepney ?



Womb being protected ? Why women don't help ?

How much is the Society or Men paying for wombs ? This penance is till which age ?

Gravitation by Prof. Subhashish Chattopadhyay SKMClasses Bangalore Useful for IIT-JEE, CBSE, I.Sc. PU-II, Boards, CET, CEE, PET, IGCSE IB AP-Physics and other exams

**People in the domestic violence field say that 'it's all about the victims.' Well, most of the times, the victim is the one arrested. Current laws are pure misandry.**

**Domestic violence facts:**

- Women are far more likely to instigate violence
- In non reciprocal violence, in 70% cases, Women are the agressors
- In reciprocal violence, Women tend to hit first
- Women are more likely to physically abuse or kill their children



**Sources:** - Daniel Whitaker, Ph.D., et al., American Journal of Public Health, May 2007  
 - Journal Partner Abuse, an unparalleled three-year research project, conducted by 42 scholars at 20 universities and research centers, and including information on 17 areas of domestic violence research - John Hamel, LCSW Editor-in-Chief  
 - <http://www.domesticviolenceresearch.org>

**STOP MALE BLAMING ! STOP THE FEMINIST LIES !**  
 Domestic Violence is NOT gender based and is NOT violence against Women !

No woman works for " Male Suicide " issues. Even-though, the rate of suicide in men are many times higher, than that of women. Women are never bothered about Men. Some women work only for "women issues " .



"It's so cool! If you use your imagination, you can blame men for *everything!*"

Gravitation by Prof. Subhashish Chattopadhyay SKMClasses Bangalore Useful for IIT-JEE, CBSE, I.Sc. PU-II, Boards, CET, CEE, PET, IGCSE IB AP-Physics and other exams

<http://www.telegraph.co.uk/men/the-filter/11965029/Middle-aged-male-suicide-rate-rises-by-40-per-cent-since-2008.html>

<http://scroll.in/article/669061/married-men-are-most-likely-to-commit-suicide-in-india>



**Texas woman who fatally shot her two daughters on her husband's birthday "wanted him to suffer"**

- Yes, mental illness was involved
- Yes, many women commit Domestic Violence
- Yes, this is an extreme case. However, many are vindictive and will use their own children against a former partner in countless other ways, over the course of many years of the child's life
- Yes, many look and act *normal* in everyday life
- Yes, too many Judges believe their theatrics

*"Happy Daughter's Day to my amazing, sweet, kind, beautiful, intelligent girls. I love and treasure you both more than you could ever possibly know." -Christy Sheats*



**The Fathers' Rights Movement**  
facebook.com/fathers4ids  
TRM.us

- Yes, fathers often stay to protect their children
- Yes, fathers face an unfair uphill battle in Family Law
- Yes, Family Law MUST be Reformed!

### Meet the Woman Who Shot Her Son with the Same Gun She Used to Kill Her Husband 20 Years Earlier

By **Afarin Majidi** - August 3, 2015

Share on Facebook | Tweet on Twitter | Like B15 | Tweet



1. Katherine Knight – Kills Husband and Eats Him.



This lady, Katherine Knight stabbed his poor husband 37 times with a butcher's knife then skinning him and hanged his body with a meat hook in their lounge room. Katherine, the first Australian woman to be sentenced to a natural life term without parole. She had a history of violence in relationships. She mashed the dentures of one of her ex-husbands and slashed the throat of another husband's eight-week-old puppy before his eyes. A heated relationship with John Charles

3. Stacey Castor, poisoned husband with antifreeze and then framed her daughter.



Stacy Castor staged a scene to make her dead husband appeared to have committed suicide but getting the cops suspicious then investigated her past only to found out that her former husband was dead from a 'heart attack'. suspicious, the cops enquire an autopsy of the former husband and found ethylene glycol substance same like the second husband's autopsy.

10. The woman who cheated on her husband after he had donated his own kidney to her.



4. Omaira Aree Nelson, Killed, Chopped Up, Cooked and Ate Husband.



Model Omaira Aree Nelson tried to grind her husband up in the garbage disposal. But she just couldn't get rid of all of 6-foot-4, 230 lbs. of him so she boiled, breaded, deep-fried and ate body parts. (Link).

Gravitation by Prof. Subhashish Chattopadhyay SKMClasses Bangalore Useful for IIT-JEE, CBSE, I.Sc. PU-II, Boards, CET, CEE, PET, IGCSE IB AP-Physics and other exams

5. Angry Wife Cuts Off Husband's Balls While He is Sleeping.



An angry Chinese woman in Xiaoxian, Jiangxi province, China, sliced off her husband's testicles while he was sleeping, in order to protect her marriage.

8. 76-year-old lady who is suspected of murdering four of her five husbands.



Jeff Carstensen was spooked when he learned his grandmother planned to buy him a \$100,000 life insurance policy – and name herself the beneficiary. As he and many others who came into Betty Neumar's orbit have learned, bad things tend to happen to the people around her.

Human beings are in general not comfortable with New ideas or New Paradigms or say new doctrines. New ideas take time to shape up !

( I am aware of Hundredth monkey effect ... scientists were conducting a study of macaque monkeys on the Japanese island of Koshima in 1952. These scientists observed that some of these monkeys learned to wash sweet potatoes, and gradually this new behavior spread through the younger generation of monkeys—in the usual fashion, through observation and repetition. Watson then concluded that the researchers observed that once a critical number of monkeys was reached, i.e., the hundredth monkey, this previously learned behavior instantly spread across the water to monkeys on nearby islands.

[https://en.wikipedia.org/wiki/Hundredth\\_monkey\\_effect](https://en.wikipedia.org/wiki/Hundredth_monkey_effect) )

<http://www.dailymail.co.uk/sciencetech/article-3317316/Monkeys-food-hygiene-Macaques-clean-potatoes-grain-eating-fewer-parasites.html>

Robindranath Thakur, the first Nobel Laureate of Asia, was follower / believer of Bromho. His father Debendranath Thakur, ( As son of Dwarkanath Tagore, a close friend of Ram Mohan Roy ) philosopher and religious reformer, active in the Brahmo Samaj ("Society of Brahmā," also translated as "Society of God"), which aimed to reform the Hindu religion and way of life. He was one of the founders in 1848 of the Brahmo religion, which today is synonymous with Brahmoism.

When Robindronath wanted to open a school in Calcutta, **many people did not want to send their children to a "Bromho Teacher "**. So In 1901 Tagore moved to Santiniketan to found an ashram.

Gravitation by Prof. Subhashish Chattopadhyay SKMClasses Bangalore Useful for IIT-JEE, CBSE, I.Sc. PU-II, Boards, CET, CEE, PET, IGCSE IB AP-Physics and other exams



Chatimtala Kaanch Ghor the Bramho Mandir, at Santiniketan

[ English People could not pronounce Thakur. They used to distort it as Tagore .... Over time the family name is called as Tagore by most non-Bengalis ]



Abdus Salam the only Physics Nobel Laureate of Pakistan was an Ahmadiyya; by faith. Ahmadiyya religion is not accepted in Pakistan. [ [The theological amendment in the constitution of Pakistan does not allow members of the Ahmadiyya faith to call themselves Muslims.](#) ] Abdus Salam had to shift to Trieste, Italy. Salam was buried in Bahishti Maqbara, a cemetery established by the Ahmadiyya Community at Rabwah, Punjab, Pakistan, next to his parents' graves. The epitaph on his tomb initially read "**First Muslim Nobel Laureate**". The Pakistani government removed "Muslim" and left only his name on the headstone. The word "Muslim" was initially obscured on the orders of a local magistrate before moving to the national level.

Gravitation by Prof. Subhashish Chattopadhyay SKMClasses Bangalore Useful for IIT-JEE, CBSE, I.Sc. PU-II, Boards, CET, CEE, PET, IGCSE IB AP-Physics and other exams



Gravitation by Prof. Subhashish Chattopadhyay SKMClasses Bangalore Useful for IIT-JEE, CBSE, I.Sc. PU-II, Boards, CET, CEE, PET, IGCSE IB AP-Physics and other exams

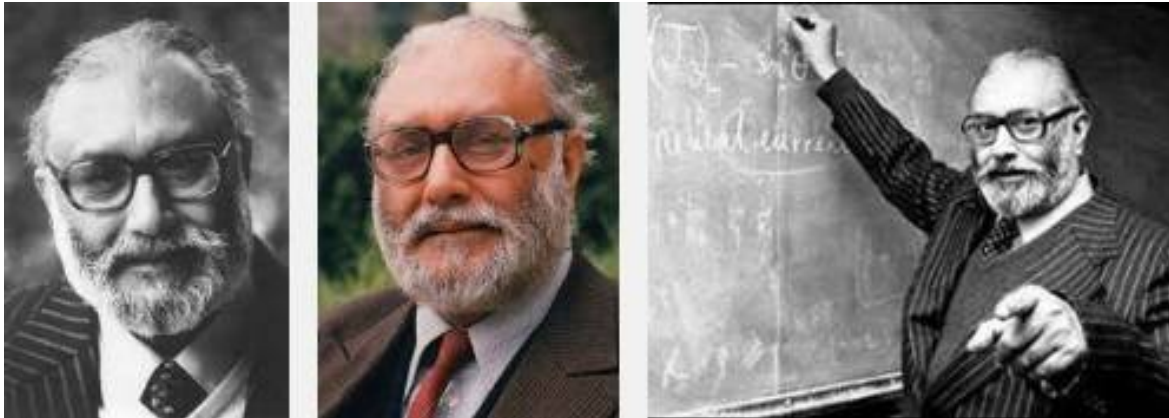

<http://blogs.tribune.com.pk/story/19695/we-are-sorry-dr-abdus-salam/>

<http://blogs.tribune.com.pk/story/31969/dr-abdus-salam-and-all-the-wrong-choices-pakistan-made/>

[http://www.nobelprize.org/nobel\\_prizes/physics/laureates/1979/salam-bio.html](http://www.nobelprize.org/nobel_prizes/physics/laureates/1979/salam-bio.html)

### **In some cases accepting the Truth takes very long time....**

Pope John Paul II apologised on behalf of the Catholic Church for the mistreatment of Galileo in the 17th century. The dispute between the Church and Galileo has long stood as one of history's great emblems of conflict between reason and dogma, science and faith. At the time of his condemnation, Galileo had won fame and the patronage of leading Italian powers like the Medicis and Barberinis for discoveries he had made with the astronomical telescope he had built. But when his observations led him to proof of the Copernican theory of the solar system, in which the sun and not the earth is the center, and which the Church regarded as heresy, Galileo was summoned to Rome by the Inquisition. **Forced to Recant.** Galileo took back his statement, but still lived under house arrest for the rest of his life. It took 359 years and the leadership of Pope John Paul II (left) to recognize the wrong. On October 31, 1992, he formally apologized for the "Galileo Case" in the first of many famous apologies during his papacy.

<https://www.youtube.com/watch?v=JUAsLcFPeNw>

History of Gravity ...

Galileo to Einstein [https://www.youtube.com/watch?v=2H\\_zvoENNXo](https://www.youtube.com/watch?v=2H_zvoENNXo)

<https://www.youtube.com/watch?v=OGQq2aB3cWE>

<https://www.youtube.com/watch?v=mPxwgyJtJXI>

Gravitation by Prof. Subhashish Chattopadhyay SKMClasses Bangalore Useful for IIT-JEE, CBSE, I.Sc. PU-II, Boards, CET, CEE, PET, IGCSE IB AP-Physics and other exams

The New York Times

World

WORLD	U.S.	N.Y. / REGION	BUSINESS	TECHNOLOGY	SCIENCE	HEALTH	SPORTS	OPINION
AFRICA	AMERICAS	ASIA PACIFIC	EUROPE	MIDDLE EAST				

## After 350 Years, Vatican Says Galileo Was Right: It Moves

By ALAN COWELL.  
Published: October 31, 1992

**ROME, Oct. 30**— More than 350 years after the Roman Catholic Church condemned Galileo, Pope John Paul II is poised to rectify one of the Church's most infamous wrongs -- the persecution of the Italian astronomer and physicist for proving the Earth moves around the Sun.

With a formal statement at the Pontifical Academy of Sciences on Saturday, Vatican officials said the Pope will formally close a 13-year investigation into the Church's condemnation of Galileo in 1633. The condemnation, which forced the astronomer and physicist to recant his discoveries, led to Galileo's house arrest for eight years before his death in 1642 at the age of 77.

The dispute between the Church and Galileo has long stood as one of history's great emblems of conflict between reason and dogma, science and faith. The Vatican's formal acknowledgement of an error, moreover, is a rarity in an institution built over centuries on the belief that the Church is the final arbiter in matters of faith.

<http://www.nytimes.com/1992/10/31/world/after-350-years-vatican-says-galileo-was-right-it-moves.html>

For new ideas .... See ...

[http://www.slate.com/articles/news\\_and\\_politics/foreigners/2009/06/the\\_herbivores\\_dilemma.html](http://www.slate.com/articles/news_and_politics/foreigners/2009/06/the_herbivores_dilemma.html)

<http://www.wisedup.org/antiphysical-men-giving-sex-relationships/>

<https://pairedlife.com/dating/Dating-10-Things-Men-Dont-Do-Anymore>

Gravitation by Prof. Subhashish Chattopadhyay SKMClasses Bangalore Useful for IIT-JEE, CBSE, I.Sc. PU-II, Boards, CET, CEE, PET, IGCSE IB AP-Physics and other exams

Random - 13 ( will you be comfortable with new ideas ? )

Almost all of us are very biased. Instead of I asking some questions; see the following images



<http://www.independent.co.uk/life-style/love-sex/women-are-genetically-programmed-to-have-affairs-evolution-university-texas-scientists-suggest-a7203501.html>



In all cultures the onus of Proving himself not guilty, lies on the Man; while it is enough for the woman just to accuse, and cry. Tears are taken as proof of Crime !

Gravitation by Prof. Subhashish Chattopadhyay SKMClasses Bangalore Useful for IIT-JEE, CBSE, I.Sc. PU-II, Boards, CET, CEE, PET, IGCSE IB AP-Physics and other exams



**All women are born  
evil. Some just realize  
their potential later in  
life than others.**

QUOTEHD.COM

Chad A. Gamble

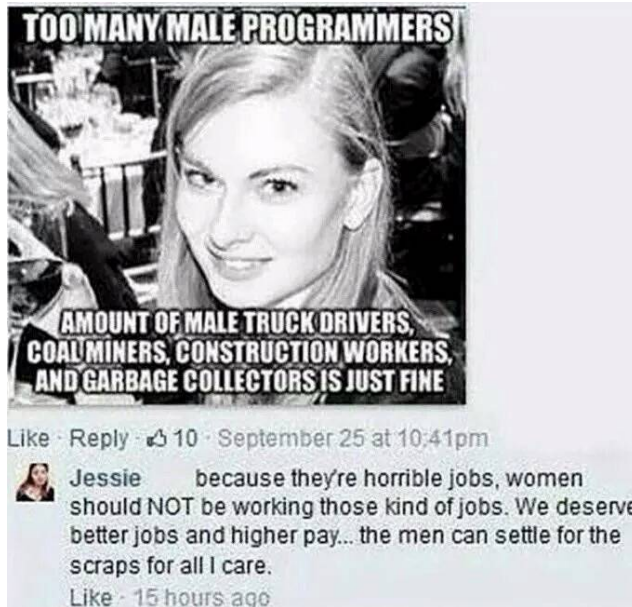

**Proof that girls are evil**

First we state that girls require time and money.

$$\text{GIRLS} = \text{TIME} \times \text{MONEY}$$

And as we all know "time is money"

$$\text{TIME} = \text{MONEY}$$

Therefore:

$$\text{GIRLS} = \text{MONEY} \times \text{MONEY} = (\text{MONEY})^2$$

And because "money is the root of all evil":

$$\text{MONEY} = \sqrt{\text{EVIL}}$$

Therefore:

$$\text{GIRLS} = (\sqrt{\text{EVIL}})^2$$

We are forced to conclude that:

$$\text{GIRLS} = \text{EVIL}$$

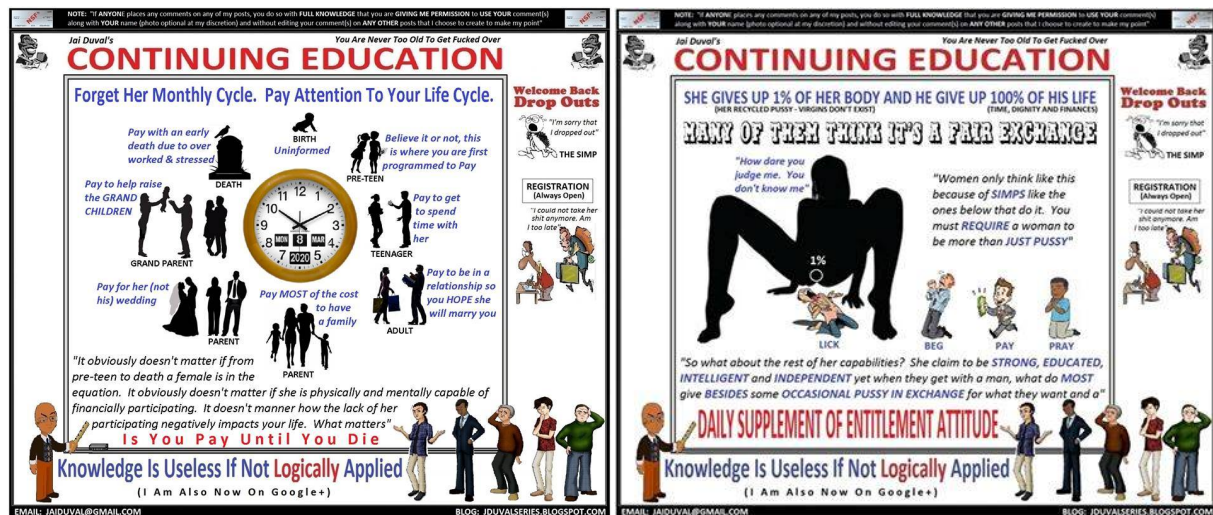

Random - 14

Rich people; often are very hard working. Successful business men, establish their business ( empire ), amass lot of wealth, with lot of difficulty. Lots of sacrifice, lots of hard work, gets into this. **Rich people's wives had no contribution in this wealth creation**. Women are smart, and successful upto the extent to choose the right/rich man to marry. So generally what happens in case of Divorces ? Search the net on " most costly divorces " and you will know. The women;( who had no contribution at all, in setting up the business / empire ), often gets in Billions, or several Millions in divorce settlements. [ [Just because the wife has womb](#) ]

Number 1

### Rupert & Anna Murdoch -- \$1.7 billion

One of the richest men in the world, **Rupert Murdoch** developed his worldwide media empire when he inherited his father's Australian newspaper in 1952. He married Anna Murdoch in the '60s and they remained together for 32 years, springing off three children.

They split amicably in 1998 but soon Rupert forced Anna off the board of News Corp and the gloves came off. The divorce was finalized in June 1999 when Rupert agreed to let his ex-wife leave with \$1.7 billion worth of his assets, \$110 million of it in cash. Seventeen days later, Rupert married Wendi Deng, one of his employees.



### Ted Danson & Casey Coates -- \$30 million

Ted Danson's claim to fame is undoubtedly his decade-long stint as Sam Malone on NBC's celebrated sitcom Cheers. While he did other TV shows and movies, he will always be known as the bartender of that place where everybody knows your name. He met his future first bride Casey, a designer, in 1976 while doing Erhard Seminars Training.

Ten years his senior, she suffered a paralyzing stroke while giving birth to their first child in 1979. In order to nurse her back to health, Danson took a break from acting for six months. But after two children and 15 years of marriage, the infatuation fell to pieces. Danson had started seeing Whoopi Goldberg while filming the comedy, Made in America and this precipitated the 1992 divorce. Casey got \$30 million for her trouble.

See <https://zookeepersblog.wordpress.com/misandry-and-men-issues-a-short-summary-at-single-place/>

See <http://skmclasses.kinja.com/save-the-male-1761788732>

**It was Boys and Men, who brought the girls / women home. The Laws are biased, completely favoring women. The men are paying for their own mistakes.**

See <https://zookeepersblog.wordpress.com/biased-laws/>

( Man brings the Woman home. When she leaves, takes away her share of big fortune! )

<http://www.uplifting-love.com/2013/08/80-percent-of-divorces-are-filed-by.html>

Random - 15

A standardized test of Intelligence will never be possible. It never happened before, nor ever will happen in future. No IQ test results will be acceptable by all. **In the net there are thousands of charts which show that the intelligence scores of girls / women are lesser.** Debates of Trillion words, does not improve performance of Girls.

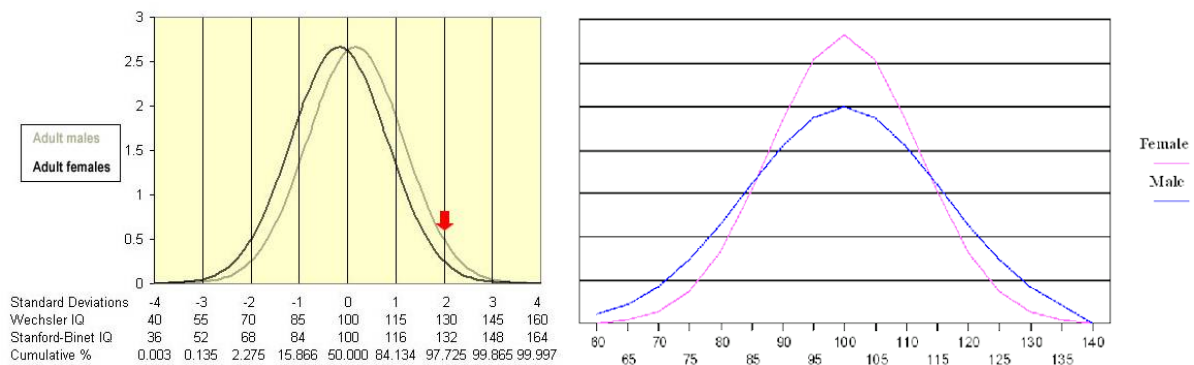

I am not wasting a single second debating or discussing with anyone, on this. **I am simply accepting ALL the results.** IQ is only one of the variables which is required for success in life. Thousands of books have been written on " Networking Skills ", EQ ( Emotional Quotient ), Drive, Dedication, Focus, " Tenacity towards the end goal " ... etc. **In each criteria, and in all together, women ( in general ) do far worse than men.** Bangalore is known as " ..... capital of India ". [ Fill in the blanks ]. The blanks are generally filled as " Software Capital ", " IT Capital ", " Startup Capital ", etc. I am member in several startup eco-systems / groups.

**I have attended hundreds of meetings, regarding " technology startups ", or " idea startups ".** These meetings have very few women. ( Generally in most meetings there are no women at all ! ). Starting up new companies are all " **Men's Game** " / " **Men's business** ". Only in Divorce settlements women will take their goodies, due to Biased laws. **There is no dedication, towards wealth creation, by women.** Women want easy money.



**Max Roscoe**

is an aspiring philosopher king, living the dream, travelling the world, hoarding FRNs and ignoring Americans. He is a European at heart, lover of Latinas, and currently residing in the USA.

July 8, 2016

Culture

## Women Who Sell Their Bodies For Money Don't Want To Be Called Prostitutes



Random - 16

Many men, as fathers, very unfortunately treat their daughters as " Princess ". Every " non-performing " woman / wife was " princess daughter " of some loving father. Pampering the girls, in name of " equal opportunity ", or " women empowerment ", have led to nothing.



See <http://skmclasses.kinja.com/progressively-daughters-become-monsters-1764484338>

See <http://skmclasses.kinja.com/vivacious-vixens-1764483974>

**There can be thousands of more such random examples, where " Bigger Shape / size " of males have influenced our culture, our Society. Let us recall the reasons,** that we already learned in standard 10 - 11, Biology text Books. In humans, women have a long gestation period, and also spends many years ( almost a decade ) to grow, nourish, and stabilize the child. ( Million years of habit ) Due to survival instinct Males want to inseminate. Boys and Men fight for the " facility ( of womb + care ) " the girl / woman may provide. Bigger size for males, has a winning advantage. Whoever wins, gets the " woman / womb / facility ". **The male who is of " Bigger Size ", has an advantage to win....** Leading to Natural selection over millions of years. In general " Bigger Males "; the " fighting instinct " in men; have led to wars, and solving tough problems ( Mathematics, Physics, Technology, startups of new businesses, Wealth creation, Unreasonable attempts to make things [ such as planes ], Hard work .... )

**So let us see the IIT-JEE results of girls.** Statistics of several years show that there are around 17, ( or less than 20 ) girls in top 1000 ranks, at all India level. Some people will yet not understand the performance, till it is said that ... **year after year we have around 980 boys in top 1000 ranks.** Generally we see only 4 to 5 girls in top 500. **In last 50 years not once any girl topped in IIT-JEE advanced.** Forget about Single digit ranks, double digit ranks by girls have been extremely rare. It is all about " good boys ", " hard working ", " focused ", "**Bel-esprit** " **boys.**



Gravitation by Prof. Subhashish Chattopadhyay SKMClasses Bangalore Useful for IIT-JEE, CBSE, I.Sc. PU-II, Boards, CET, CEE, PET, IGCSE IB AP-Physics and other exams

**In 2015, Only 2.6% of total candidates who qualified are girls ( upto around 12,000 rank ). while 20% of the Boys, amongst all candidates qualified.** The Total number of students who appeared for the exam were around 1.4 million for IIT-JEE main. Subsequently 1.2 lakh ( around 120 thousands ) appeared for IIT-JEE advanced.

IIT-JEE results and analysis, of many years is given at

<https://zookeepersblog.wordpress.com/iit-jee-iseet-main-and-advanced-results/>

**In Bangalore it is rare to see a girl with rank better than 1000 in IIT-JEE advanced. We hardly see 6-7 boys with rank better than 1000. Hardly 2-3 boys get a rank better than 500.**

See <http://skmclasses.weebly.com/everybody-knows-so-you-should-also-know.html>

### So what " some women " are doing ?

Thousands of people are exposing the heinous crimes that Motherly Women are doing, or Female Teachers are committing. See <https://www.facebook.com/WomenCriminals/>

Some Random Examples must be known by all

It is extremely unfortunate that the " woman empowerment " has created. This is the kind of society and women we have now. I and many other sensible Men hate such women. Be away from such women, be aware of reality.



Mother Admits On Facebook to Sleeping with 15 Yr Old Son, They Have a Baby Together - Alwayzturmtup

Sometimes it hard to believe w From Alwayzturmtup

ALWAYZTURNUP.ME



'Sex with my son is incredible - we're in love and we want a baby'

Ben Ford, who ditched his wife when he met his mother Kim West after 30 years, claims what the couple are doing isn't incest

MIRROR.CO.UK

Gravitation by Prof. Subhashish Chattopadhyay SKMClasses Bangalore Useful for IIT-JEE, CBSE, I.Sc. PU-II, Boards, CET, CEE, PET, IGCSE IB AP-Physics and other exams

Woman sent to jail for the rest of her life after raping her four grandchildren is described as the 'most evil person' the judge has ever seen

Edwina Louis rape...

[See More](#)



### Former Shelbyville ISD teacher who had sex with underage student gets 3 years in prison

After a two day break over the weekend, A Shelby County jury was back in the courtroom looking to conclude the trial of a former Shelbyville ISD teacher who had...

KLTV.COM | BY CALEB BEAMES

<http://www.thenativecanadian.com/.../eastern-ontario-teacher-...>



### Woman sent to jail for raping her four grandchildren

A Ohio grandmother has been sentenced to four consecutive life terms after being found guilty of the rape of her own grandchildren. Edwina Louis, 53, will spend the rest of her life behind bars.

DAILYMAIL.CO.UK



### The N.C. Chronicles.: Eastern Ontario teacher charged with 36 sexual offences

anti feminism, Child abuse, children's rights, Feminist hypocrisy,

THENATIVECANADIAN.COM | BY BLACKWOLF



### Hyd woman kills newborn boy as she wanted daughter - Times of India

Having failed to bear a daughter for the third time, a shopkeeper's wife slit the throat of her 24day-old son with a shaving blade and left him to die in a street on Tuesday night.Pumima's first child was a stillborn boy, followed by another boy born five years ago.

TIMESOFINDIA.INDIATIMES.COM

Gravitation by Prof. Subhashish Chattopadhyay SKMClasses Bangalore Useful for IIT-JEE, CBSE, I.Sc. PU-II, Boards, CET, CEE, PET, IGCSE IB AP-Physics and other exams

Montgomery's son, Alan Vonn Webb, took the stand and was a key witness in her conviction.

"I want to see her placed somewhere she can never do that to children

....

See More



**Woman sentenced to 40 years in prison for raping her children**

A Murfreesboro mother found guilty of raping her own children learned her fate on Wednesday.

WAFF.COM | BY DENNIS FERRIER

gentler sex? Violence against men.'s photo.



**Up to 64,000 women in UK are child-sex offenders**

~ The Guardian

**Women, the gentler sex? Violence against men.**

April 8 at 1:38am · 🌐

Like Page

In fact, the past decade has seen a dramatic increase in the number of incidents of women raping and sexually assaulting boys and men. On May 2014, Jezebel repo...

In Facebook, and internet + whatsapp etc we have unending number of posts describing frustration of men / husbands on naughty unreasonable women. **Most women are very illogical, Punic, perfidious, treacherous, naughty, gamey bitches.**

We also see zillions of Jokes which basically describe how unreasonable women / girls are. How stupid they are, making life of Boys / Men / Husband a hell.

While each of these girls was someones daughter. Millions of foolish Dads are into Fathers rights movement, who want their daughter back for pampering.

Most girls are being cockered, coddled, cosseted, mollycoddled, featherbedded, spoilt into brats.

**Foolish fathers are breeding Monsters who are filing false rape cases. Enacting Biased Laws. Filing False domestic violence cases. Filing false sexual assault cases. Asking for alimony, and taking custody of the Daughter, not allowing the " monster " to meet dad. The cycle goes on and on and on.**

Foolish men keep pampering future demons who make other Men's life a hell. ( Now read this again from beginning ). Every day we see the same posts of frustration.

Gravitation by Prof. Subhashish Chattopadhyay SKMClasses Bangalore Useful for IIT-JEE, CBSE, I.Sc. PU-II, Boards, CET, CEE, PET, IGCSE IB AP-Physics and other exams



**When I grow up  
I will beat my  
husband  
No one will care  
No one will stop me**



October is Domestic  
Violence Awareness Month.

**53% of Domestic Violence  
Victims are Men  
Stop the Silence  
Stop the Violence**



**FUNNY.**

**NOT FUNNY.**

**DOUBLE STANDARDS HURT  
EVERYONE.**

<https://nicewomen.wordpress.com/>

Each women as described below was someone's Pampered Princess ...

End violence against women . . . .



**North Carolina Grandma Eats Her Daughter's New Born  
Baby After Smoking Bath Salts**

Henderson, North Carolina—A North Carolina grandmother of 4 and recovering drug addict, is now in custody after she allegedly ate her daughter's newborn baby....

AZ-365.TOP



**28-Year-Old Texas Teacher Accused of Sending Nude  
Picture to 14-Year-Old Former Student**

BREITBART.COM

Gravitation by Prof. Subhashish Chattopadhyay SKMClasses Bangalore Useful for IIT-JEE, CBSE, I.Sc. PU-II, Boards, CET, CEE, PET, IGCSE IB AP-Physics and other exams

<http://latest.com/.../attractive-girl-gang-lured-men-alleywa.../>



### Attractive Girl Gang Lured Men Into Alleyways Where Female Body Builder Would Attack Them

A Mexican street gang made up entirely of women has been accused of using their feminine wiles to lure men into alleyways and then beating them up and...

LATEST.COM

<http://www.wfmj.com/.../youngstown-woman-convicted-of-raping-...>



### Youngstown woman convicted of raping a 1 year old is back in jail

A Youngstown woman who went to prison for raping a 1-year-old boy fifteen years ago is in trouble with the law again.

WFMJ.COM

End violence against women ...



### Women are raping boys and young men

Rape advocacy has been maligned and twisted into a political agenda controlled by radicalized activists. Tim Patten takes a razor keen and well supported look into the manufactured rape culture and...

AVOICEFORMEN.COM | BY TIM PATTEN



### Bronx Woman Convicted of Poisoning and Drowning Her Children

Lisette Barnenga researched methods on the Internet before she killed her son and daughter in 2012.

NYTIMES.COM | BY MARC SANTORA

Monster women have very easy and cozy life. Easy to demand anything and get law in favor !

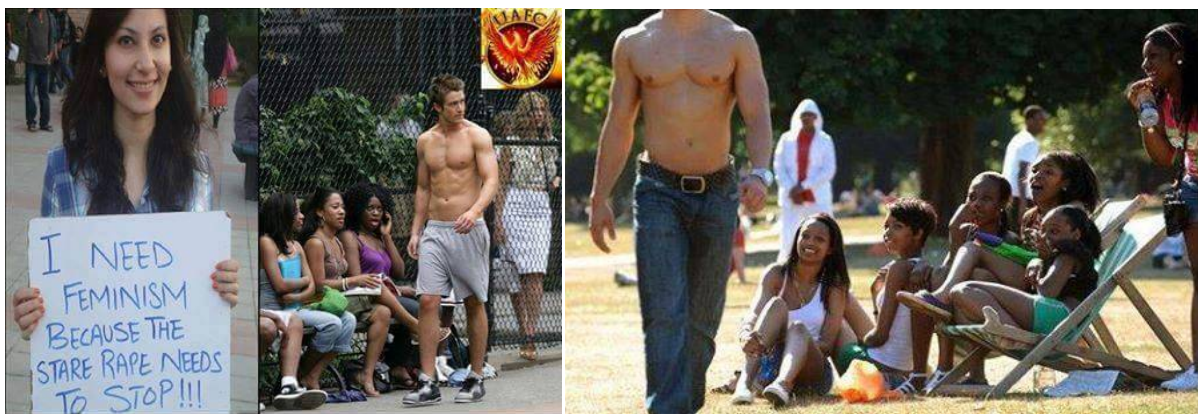

**If the lawmakers submit to these strange demands of say ... " Stare Rape ! "; then we can easily see what kind of havoc that will create.**

Gravitation by Prof. Subhashish Chattopadhyay SKMClasses Bangalore Useful for IIT-JEE, CBSE, I.Sc. PU-II, Boards, CET, CEE, PET, IGCSE IB AP-Physics and other exams

**55%**  
of Biological Parents  
Who Kill Their Children are  
**Mothers**

Homicidal Encounters: A Study of Homicide in Australia 1989-1999.  
Australian Institute of Criminology (Monash, 2000, p. 142, Fig. 74).

**ManKind**  
Equality Network



**Woman charged with killing baby also had previous infant die**

Woman charged with killing baby also had previous infant die

ABC7.COM | BY ROB MCMILLAN



**Female Sex Predators: A Crime Epidemic** shared a link.

Yesterday at 12:40am · 🌐



**WTVA.com | Woman pleads guilty to having sex with a dog**

PITTSBORO, Miss. (WTVA) -- A Calhoun County woman has pleaded guilty to charges she had unnatural intercourse with a dog. Sheriff Greg Poll

WTVA.COM

👍 Like    💬 Comment    ➦ Share

👍 🤔 🤢 Mhra Leander Pallat, Eric Antonio Alvarado and 31 others    Top Comments ▾



**Oklahoma Teacher Receives 15-Year Prison Sentence For Sex With 15-Year-Old Boy**

A former Oklahoma middle school teacher has pleaded guilty to 6 counts of rape, child enticement...

THREEPERCENTERNATION.COM

A Russian-born newlywed slowly butchered her German husband — feeding strips of his flesh to their dog until he took his last breath. Svetlana Batukova, 46, was...

[See More](#)



### She killed her husband and then fed him to her dog: police

A Russian-born newlywed butchered her German hubby — and fed strips of his flesh to her pooch, authorities said. Svetlana Batukova offered Horst Hans Henkels at their...

NYPOST.COM

 **Daily Mail**  
January 15, 2015 ·

Mother charged with rape and sodomy of her son's 12-year-old friend



### Mom, 30, 'raped and had oral sex with her son's 12-year-old friend'

Nicole Marie Smith, 30, (pictured) of St Charles County, Missouri, has been jailed after she allegedly targeted the 12-year-old boy at her home.

DAILYMAIL

April 4 at 4:48am ·



### Female prison officers commit 90pc of sex assaults on male teens in US juvenile detention centres

Lawsuit in Idaho highlights the prevalence of sexual victimization of juvenile offenders.

IBTIMES.CO.UK | BY NICOLE ROJAS

This mother filmed herself raping her own son and then sold it to a man for \$300. The courts just decide her fate. When you see what she got, you're going to be outraged.



### Mother Who Filmed Herself Raping Her 1-Year-Old Son Receives Shocking Sentence

"...then used the money to buy herself a laptop..."

AMERICANNEWS.COM

**In several countries or rather in several regions of the world, family system has collapsed, due to bad nature and naughty acts of women.** Particularly in Britain, and America, almost 50% people are alone, lonely, separated, divorced or failed marriages. In 2013, 48% children were born out of wedlock. **It was projected that by 2016, more than 51% children will be born, to unmarried mothers.** In these developed countries " paternity fraud " by women, are close to 20%. You can see several articles in the net, and in wikipedia etc. This means 1 out of 5 children are calling a wrong man as dad. The lonely, alone " mothers " are frustrated. They see the children as burden. Love in the Society in general is lost, long time ago. The types of " Mothers " and " Women " we have now .....

This is the type of women we have in this world. These kind of women were also someones daughter



### Mother Stabs Her Baby 90 Times With Scissors After He Bit Her While Breastfeeding Him!

Eight-month-old Xiao Bao was discovered by his uncle in a pool of blood. He needed 100 stitches after the incident; he is now recovering in hospital. Reports say his...

MOMMABUZZ.COM





### Not All Feminist Theory is Equal

<p>Christina Hoff Sommers Factual and Equity Feminist</p> 	<p>Andrea Dworkin Radical and Gender Feminist</p> 
<p>"That is the corrosive paradox of gender feminism's misandrist stance: no group of women can wage war on men without at the same time denigrating the women who respect those men."</p>	<p>"Under patriarchy, every woman's son is her potential betrayer and also the inevitable rapist or exploiter of another woman"</p>

**ManKind**  
Equality Network

### WILLFUL BLINDNESS

Ignoring the Majority of Victims Because of Their Gender

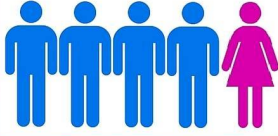
<p>I am a feminist because it bothers me that a woman gets killed by her male partner every single week, and somehow that doesn't qualify as a tools-down national crisis even though if a man got killed by a shark every week we'd probably arrange to have the ocean drained.</p> <p style="text-align: right;">Annabel Crabb</p>	<p><b>79%</b> of Homicide victims worldwide are <b>MALE</b></p> <p>"Where is the tools-down national crisis?"</p> 
--	---

United Nations Office of Drugs and Alcohol. Global Study on Homicide (2013, p. 13).  
https://en.wikipedia.org/wiki/Willful\_blindness

**ManKind**  
Equality Network

### Not All Feminist Theory is Equal

<p>Christina Hoff Sommers Equity Feminist</p> 	<p>Valerie Solanis Radical and Gender Feminist</p> 
<p>Christina H. Sommers @CH-Sommers</p> <p>Want to close wage gap? Step one: Change your major from feminist dance therapy to electrical engineering.</p>	<p>"To call a man an animal is to flatter him; he's a machine, a walking dildo"</p> <p style="text-align: right;"><small>n.b. Some Feminists</small></p>

**ManKind**  
Equality Network



**Muslim Woman Caught RAPING Her Own Son - Gives Disgusting Excuse to Judge | John Hawkins' Right Wing News**

RIGHTWINGNEWS.COM

By now if you have assumed that Indian women are not doing any crime then please become friends with MRA Guri <https://www.facebook.com/profile.php?id=100004138754180>

He has dedicated his life to expose Indian Criminals



**Delhi Woman Who Tried To Rape An Auto Driver, While Her Friend Filmed The Act, Has Been Arrested**

Men are raped too!

MENSPX.COM | BY NIKITA MUKHERJEE



**Muslim mother, 43, jailed for sex offences against girl, nine**

Raheelah Dar, 43, from Middlesbrough, has been jailed for seven years for carrying out a string of sex offences against a nine-year-old girl.

DAILYMAIL.CO.UK

# MailOnline

U.K. | India | U.S. | **News** | Sport | TV&Showbiz | Femail | Health | Science | Money | Video | Latest Headlines | News | World News | Arts | Headlines | France | Pictures | Most read | News Board | Wires

## Mother who had been forced into an arranged marriage is jailed for filming herself having sex with her 14-year-old son and sending the clips to relatives in Pakistan

- Vile mother filmed having sex with her teenage son in sick porn video
- Clips sent to cousin in Pakistan who allegedly asked her to make film
- She also sent her relative indecent images of her three-year-old daughter

By **ALEX MATTHEWS FOR MAILONLINE**

PUBLISHED: 12:44 GMT, 1 August 2016 | UPDATED: 11:23 GMT, 2 August 2016



## Wife Stabs Husband And Runs Away After He Stops Her From Gambling

The husband said his wife had become a habitual gambler who was also addicted to liquor.

INDIATIMES.COM



## Teacher learns fate for 6 months of sex with boy

(CBS8) — SAN DIEGO (CNS) — A Crawford High School teacher and coach who carried on a six-month sexual relationship with a 15-year-old male student was sentenced Friday to a two-year prison term. Toni Nicole Sutton, 38, pleaded guilty...

WIND.COM



## Mom jailed for 40 years after body of daughter, 9, found in fridge

Amber Keyes, 37, was sentenced in the death of Ayahna Comb in Houston on Friday. Ayahna, who had cerebral palsy, had been in the fridge for six months...

DAILYMAIL.CO.UK

# HURT FEMINISM BY DOING NOTHING

- ✗ DON'T HELP WOMEN
- ✗ DON'T FIX THINGS FOR WOMEN
- ✗ DON'T SUPPORT WOMEN'S ISSUES
- ✗ DON'T COME TO WOMEN'S DEFENSE<sup>1</sup>
- ✗ DON'T SPEAK FOR WOMEN
- ✗ DON'T VALUE WOMEN'S FEELINGS
- ✗ DON'T PORTRAY WOMEN AS VICTIMS
- ✗ DON'T PROTECT WOMEN<sup>2</sup>

✓ WITHOUT WHITE KNIGHTS FEMINISM WOULD END TODAY

<sup>1</sup>Don't even nawalt ("Not All Women Are Like That")     <sup>2</sup>for example from criticism or insults

### How Society prioritize Men

High Priority

Low Priority

<b>Rich women</b>		They can get away with murder.
<b>Women</b>		They get all the rights with no responsibility and Shelters for Homeless women.
<b>Rich Men</b>		They get tax bail outs and short prison sentence.
<b>Girls</b>		They get educational benefits but no violence against kids Act.
<b>Boys</b>		They have some support but don't have any education that fits boys.
<b>Animals</b>		They have animal rights and PETA.
<b>Prisoners</b>		They get conjugal visits and 3 squares and a roof.
<b>Men</b>		Paid slaves.
<b>Poor Men</b>		Nothing.

**Who pays the most Taxes?**  
This is why MGTOW exist.

# M G T O W



Professor Subhashish Chattopadhyay

### Preface for Science

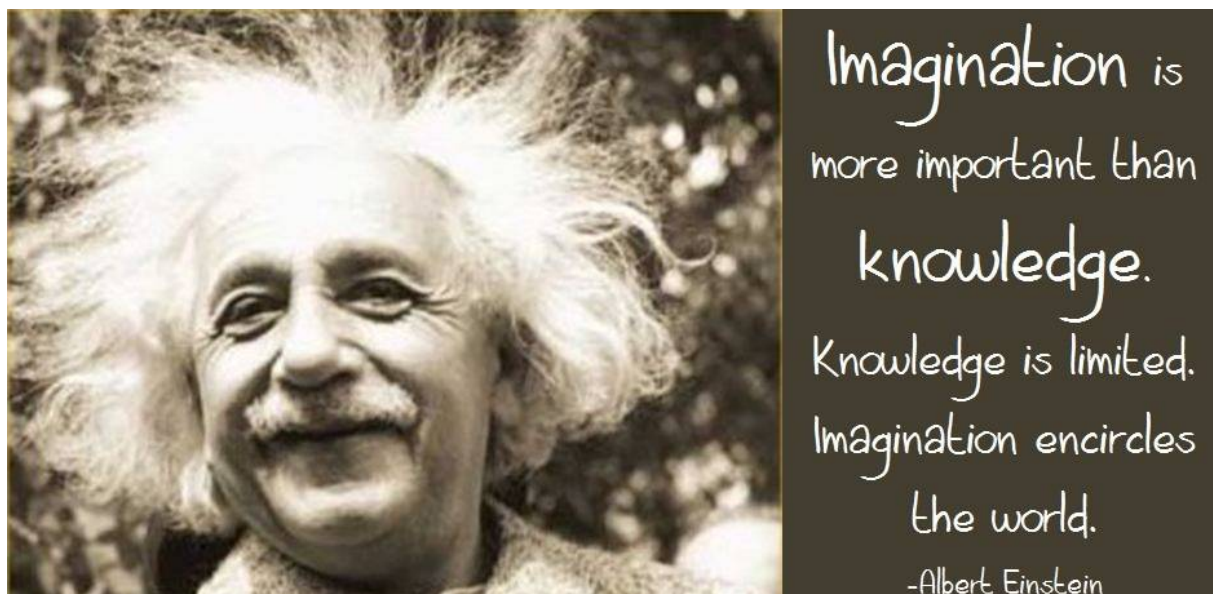

Many Scientists have made, very good TV programs; to teach Science. Carl Sagan, Desmond Morris, Jacques Cousteau, Neil deGrass Tyson, James Burke, Jacob Bronowski, Bill Nye, Andrew Pontzen, Sean Carroll, Michio Kaku ... the list is long. BBC, Discovery Channel, Nova, Nature, Science Planet .... the list of good Channels is big.

Even though these programs are being delivered free, ( add education programs of Govt. of India, which are also very good ); not sure how many are correctly learning.

As I randomly talk to lots of students ... I find ...

The Science understanding of Urban, Rich children, in general; is abysmal.

**The Science fiction movies, showing Aliens; or winning war with Aliens are more popular and influential. Doraemon making "time machine" so easily, and doing "time travel" so often intrigues children more.** ( for General Knowledge see <http://skmclasses.weebly.com> )

India is an uniquely peculiar country; has 1.3 Billion people, obsessed with thousands of stupid things. Superstitious Religious Rituals, Hundreds of festivals, 'What to do' and 'what not to do' [ on a full moon day, on a No Moon day, on 11 th day of Lunar month ], before and after an eclipse, what to eat and what not to eat, what to wear and what not to wear, Caste, Gotra, "methods and steps" for Puja or Prayer, **hundreds of ways to control or restrict or influence others** etc... ; keeps people busy.

**Students have major influence and learning's from these superstitious life style, and fiction / 'stupid movies' rather than from good Science TV shows.**

[ if you ask any Science Question to any student, first reaction is "Ye to course mein nahi hai"! ]

Gravitation by Prof. Subhashish Chattopadhyay SKMClasses Bangalore Useful for IIT-JEE, CBSE, I.Sc. PU-II, Boards, CET, CEE, PET, IGCSE IB AP-Physics and other exams

Another most important obsession of Indians is to become Engineers; well somehow .... 14 Lakh ( 1.4 million ) students appear for IIT JEE exam. ( Not about IITs or NITs etc ) Almost all are stark idiots; study "Engineering" in some college or other .... the story goes on.

**In general students / people in India do not know or understand the following ...**

One of the most important drawbacks of Human beings is **Anthropophilia**. We love to imagine that ... God, Aliens, Robots etc, are similar to us. Tell a small child to draw a Robot, and almost 100% cases you see a Humanoid being drawn. It is not about the child being intelligent or smart. It is a fundamental 'mental block' that we harbor in general. [ *when I was a kid, and if someone had told me to draw a Robot, I would have surely drawn a Humanoid* ]

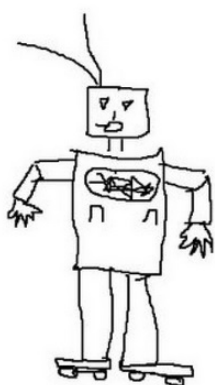

( if I tell you to draw a "Chemical Robot" then ? )



We feel comfortable with Humanoid Robots only

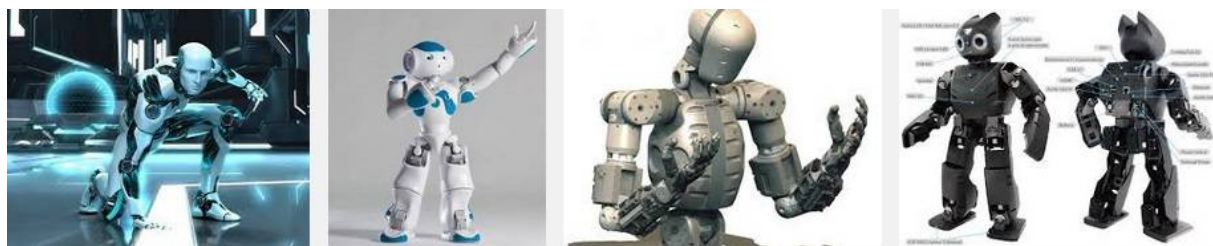

**It takes lot of Training and maturity to understand that all machines are Robots. A car is a Robot. A crane is a Robot. Mars Rover is a Robot. Robots can be of any size and shape, serving a particular purpose.**

Similarly Aliens do not have to look like us. We have five fingers in our hands, and five toes in our legs because Monkeys have the same. We all evolved step by step from some primitive fish, which had five bones / cartilages in its fins. The fish from which we all evolved had 2 pairs of fins. The pair of fins which was nearer to the head became hands, and the pair at the rear became legs.

Gravitation by Prof. Subhashish Chattopadhyay SKMClasses Bangalore Useful for IIT-JEE, CBSE, I.Sc. PU-II, Boards, CET, CEE, PET, IGCSE IB AP-Physics and other exams

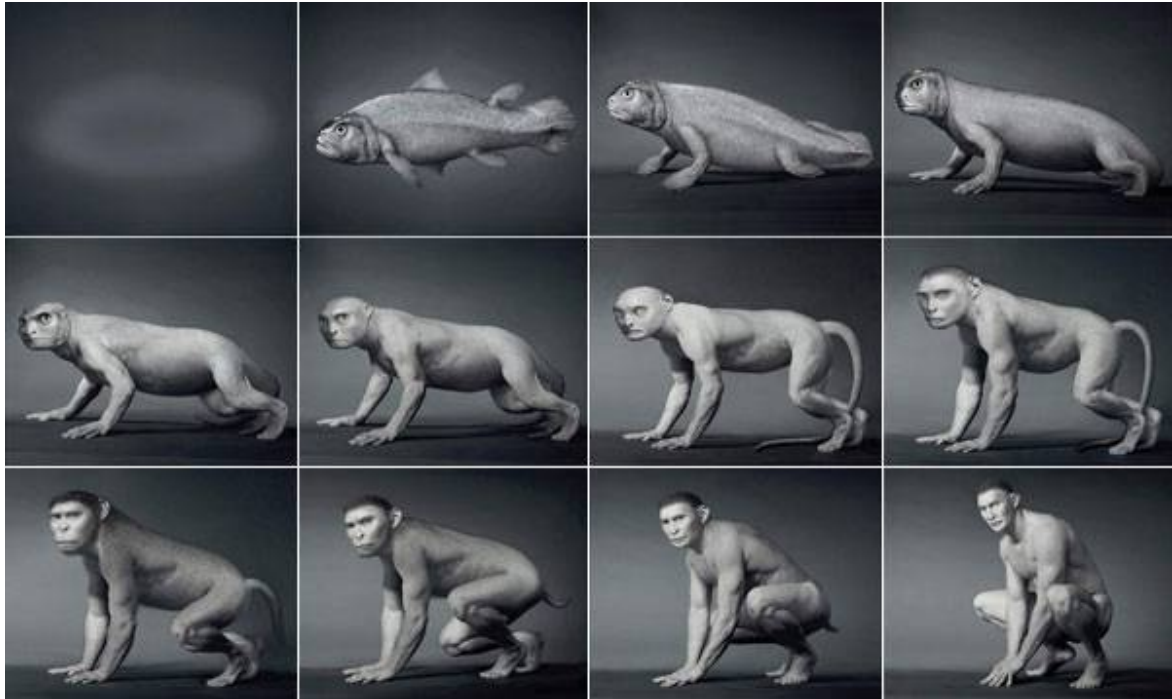

Now imagine an Alien evolving from a fish, which had 3 pairs of fins ! or say 17 pairs ! then that may lead to ....

**Some children will be quick to identify that Aliens may not evolve from fish, can be different pathways ... in that case they will look very different from us isn't it !**

**As I write all these in 2016, I say .... " Soon we will find various life-forms in Mars, Moons of Jupiter, Jupiter, and Asteroids ! "**

Back to Anthropophilia ... It is very difficult to get rid of this. Christiaan Huygens the great Dutch Scientist 'logically concluded' from observations as follows ...

Jupiter has Atmosphere, so it will rain in Jupiter, so Jupiter must have seas and Oceans, so the "life forms" in Jupiter must have boats, the boats need rope, and rope must be made from trees / fiber, so "they" should have hemp plants ...

Huygens was the first to make a submarine which could go down in water, by a few meters. In those days, around 1650 there was no plane, rocket or space travel. So do you see Huygens could not imagine Aliens in Jupiter flying in Planes or Rockets. While movies now show Aliens in Rockets!

[ **Students must know about various limitations of Human beings.** Professor Daniel Kahnemen ( 2002 Nobel Laureate ) has long list of Human Limitations in his book.

see [https://vk.com/doc23267904\\_175119602](https://vk.com/doc23267904_175119602)

Gravitation by Prof. Subhashish Chattopadhyay SKMClasses Bangalore Useful for IIT-JEE, CBSE, I.Sc. PU-II, Boards, CET, CEE, PET, IGCSE IB AP-Physics and other exams

I collected some limitations, and wrote an article. See <http://skmclasses.kinja.com/bias-we-all-are-biased-1761664826>

Scientists have advised a list of "must learn" for students, to appreciate / understand Science better.

See Read <http://edge.org/responses/what-scientific-concept-would-improve-everybodys-cognitive-toolkit>

**It is mandatory for students; to know all the points given in the above links; whom I personally teach ]**

Chimps and Humans have 96 Percent common genes; Research and Gene Study Finds. **But Humans and Chimps can't communicate, or discuss.** Orangutans are our nearest relatives. We humans are 97% the same as orangutans, gene study shows. But we can't converse with any other species. A little bit of sign language of say 100 "words" or a Dog understanding "instructions" of his master is **not** what is being referred here. **Earth has several Million species, while observations as of now, does not show "communication" across two separate species.** Let us not bring in Symbiotic relationship into this. It is about intelligent communication, discussions, debate, learning from each other etc. Can Humans communicate with insects or birds chirping ?

Imagine a World where Lions were communicating with insects, or say Otters communicating with birds ! The ecosystem as we know, has all these staying together ... so close ! All like a family !!

**Now do we see the limitations about our obsession, with "communicating" with Aliens ?**

The nearest stars are several light years away. Even if we improve the technology to travel 1000 times faster than the fastest rockets it will take thousands of years to travel to nearest "Earth like" planets. **I personally rule out any more discussions on travelling and meeting and communicating with Aliens.**

The life forms ( which we will soon find ) in Mars, Moons of Jupiter, Jupiter etc **have to be analyzed for DNA.** Will these life-forms have DNA ? Will these Aliens have molecules similar to what we see in organisms here in Earth ? These are important questions in Xenobiology, Astrobiology etc. **We have to wait for data.**

**Science is study of data, experimental verification, logical conclusions.**

We have made XNA. We have made various kinds of Artificial life, including Arsenic, Selenium based pathways. But extremeophiles also have the same kind of DNA or molecules that we see in all organisms. Same kinds of mRNA etc. Why didn't life grow and evolve multiple times ? We don't know as of now. Or did life evolve / grow multiple times in the same way ? Intelligent human beings will keep researching, and we will know the answers.

Gravitation by Prof. Subhashish Chattopadhyay SKMClasses Bangalore Useful for IIT-JEE, CBSE, I.Sc. PU-II, Boards, CET, CEE, PET, IGCSE IB AP-Physics and other exams

Gravitation by Prof. Subhashish Chattopadhyay SKMClasses Bangalore Useful for IIT-JEE, CBSE, I.Sc. PU-II, Boards, CET, CEE, PET, IGCSE IB AP-Physics and other exams

The only Sanskrit word in Standard 11-12 Science CBSE text books is Tincal ( which is the word for Borax). The books ( rightly ) are full with German names. Students are unaware the Potassium was derived from an Arabic word Potash, ashes of ( roots ) of plant.

( not talking about last 50 or 100 years ) **Not a single chemical element were purified / synthesized or discovered in India, by any Indian.** Indium (In = #49): Indicum (Latin) means indigo. The pigment indigo was named after indicon (Greek) in allusion for its coming from India. On August 18th, 1868 by French astronomer Jules Janssen. While in Guntur, India, Janssen observed a solar eclipse through a prism, whereupon he noticed a bright yellow spectral line (at 587.49 nanometers) emanating from the chromosphere of the Sun. This led to discovery of Helium. In 1937, Discovery of Astatin was reported by the chemist Rajendralal De. Working in Dacca in British India (now Dhaka in Bangladesh), he chose the name "**dakin**" for element 85, which he claimed to have isolated as the thorium series equivalent of radium F (polonium-210) in the radium series. The properties he reported for **dakin** do not correspond to those of astatine; moreover, astatine is not found in the thorium series, and the true identity of **dakin** is not known.

[ not considering the ancient elements which were known to others also ... Supher, Zinc, Mercury and <http://www.thehindu.com/sci-tech/science/indian-role-in-producing-superheavy-element-117/article5986191.ece> ]

As a culture Indians preferred Ayurveda. Identify the trees, smash the leaves, take the bark and / or the roots, make a paste, in some cases add honey etc ... and this paste or potion cures everything. If we do not have a medicine for some disease, or if the medicine is not effective, then the argument is ... "we did not search the trees in the jungle enough !". The belief being solution / medicine for every disease is out there in the jungle!

**This culture is grossly opposite to get into the details, identify the molecules, find the reaction pathways.** Modern techniques is not seen as good. In fact opposite ... **older things are considered better**. The claim often is "some grandfather's grandfather was a great Ayurvedic Doctor, since several generations they are using some paste, and they now the best.

**With this kind of a culture Indians cannot and did not find pharmacophores.**

[ see <http://www.eurekaselect.com/81348/article>

<http://www.ucdenver.edu/academics/colleges/medicalschoo/department/Pharmacology/Pages/history.aspx>

<http://adaptogens.org/adaptogen/history> ]

An extremely superstitious culture, avoiding to get-into any details, easy way of "chalta hai" had its Dark effect. Indians are averages and poor, because hardly there was any value-add !

**Most people in India; think in the following way ...**

Gravitation by Prof. Subhashish Chattopadhyay SKMClasses Bangalore Useful for IIT-JEE, CBSE, I.Sc. PU-II, Boards, CET, CEE, PET, IGCSE IB AP-Physics and other exams





**Let us see contribution of some Mathematicians and Scientists; who did great work but students generally don't know about them.**

**Eugene Wigner** - After his sojourn in Berlin, Wigner returned to Budapest to work in his father's tannery. Somehow and somewhere from there, he returned to Berlin joining the Kaiser Wilhelm Institute working first under Karl Weissenberg and later under Richard Becker. There he explored quantum mechanics of Erwin Schrödinger and group theory (founded by the genius Evariste Galois who was obsessed with polynomials equations and their solutions). At the age of 25, in 1927, in Germany somewhere he introduced the group theory into quantum mechanics. He published it formally in 1931 at the age of 29:

**"Group Theory and Its Application to the Quantum Mechanics of Atomic Spectra."**

He soon thereafter introduced symmetries (rotations, translations, and CPT- charge parity and time reversal symmetry) into quantum mechanics. He formulated and proved a theorem which became the cornerstone of the mathematical formulations of quantum mechanics. Eugene Wigner was so impressed with the usefulness of abstract mathematics in nuclear physics and quantum mechanics that he went on to write a landmark article in 1960 titled:

"The Unreasonable Effectiveness of Mathematics in the Natural Sciences".

In 1930, Princeton University recruited both Jeno Pal Wigner and Janos Von Neumann at 7 times the salary they were drawing in Europe. Both these geniuses anglicized their first names to "Eugene" and "John" respectively and soon thereafter became naturalized citizens of the United States.

-

**Janos Bolyai** (Transylvania, Hapsburg Empire) 1822 - one of the founders of non-Euclidean geometry – a geometry that differs from Euclidean geometry in its definition of parallel lines. The discovery of a consistent alternative geometry that might correspond to the structure of the universe helped to free mathematicians to study abstract concepts irrespective of any possible connection with the physical world.

Gravitation by Prof. Subhashish Chattopadhyay SKMClasses Bangalore Useful for IIT-JEE, CBSE, I.Sc. PU-II, Boards, CET, CEE, PET, IGCSE IB AP-Physics and other exams

**Nikolai Ivanovich Lobachevsky** (Kazan, Russia) 1823 - known primarily for his work on hyperbolic geometry, otherwise known as Lobachevskian geometry. William Kingdon Clifford called Lobachevsky the "Copernicus of Geometry" due to the revolutionary character of his work. He was dismissed from the university in 1846, ostensibly due to his deteriorating health: by the early 1850s, he was nearly blind and unable to walk. He died in poverty in 1856.

**Nikolai was an atheist.**

-

**Bernhard Riemann** (Breselenz, Jameln, Kingdom of Hanover) 1853: student of Gauss - Influential German mathematician who made lasting and revolutionary contributions to analysis, number theory, and differential geometry. In the field of real analysis, he is mostly known for the first rigorous formulation of the integral, the Riemann integral, and his work on Fourier series. His contributions to complex analysis include most notably the introduction of Riemann surfaces, breaking new ground in a natural, geometric treatment of complex analysis. His famous 1859 paper on the prime-counting function, containing the original statement of the Riemann hypothesis, is regarded, although it is his only paper in the field, as one of the most influential papers in analytic number theory. Through his pioneering contributions to differential geometry, Riemann laid the foundations of the mathematics of general relativity.

-

**Felix Klein** (Düsseldorf, Prussia) 1870s - German mathematician and mathematics educator, known for his work in group theory, complex analysis, non-Euclidean geometry, and on the connections between geometry and group theory. His 1872 Erlangen Program, classifying geometries by their underlying symmetry groups, was a hugely influential synthesis of much of the mathematics of the day.

-

**Marcel Grossman** (Budapest) 1910s tutored Einstein on differential geometry and tensor calculus - mathematician and a friend and classmate of Albert Einstein. Grossmann was a member of an old Swiss family from Zurich. His father managed a textile factory. He became a Professor of Mathematics at the Federal Polytechnic Institute in Zurich, today the ETH Zurich, specializing in descriptive geometry.

-

**Gregorio Ricci-Curbastro** (Italy) 1880s - Italian mathematician born in Lugo di Romagna. He is most famous as the inventor of tensor calculus, but also published important works in other fields. With his former student Tullio Levi-Civita, he wrote his most famous single publication, a pioneering work on the calculus of tensors, signing it as Gregorio Ricci. This appears to be the only time that Ricci-Curbastro used the shortened form of his name in a publication, and

Gravitation by Prof. Subhashish Chattopadhyay SKMClasses Bangalore Useful for IIT-JEE, CBSE, I.Sc. PU-II, Boards, CET, CEE, PET, IGCSE IB AP-Physics and other exams

Gravitation by Prof. Subhashish Chattopadhyay SKMClasses Bangalore Useful for IIT-JEE, CBSE, I.Sc. PU-II, Boards, CET, CEE, PET, IGCSE IB AP-Physics and other exams

continues to cause confusion. Ricci-Curbastro also published important works in other fields, including a book on higher algebra and infinitesimal analysis, and papers on the theory of real numbers, an area in which he extended the research begun by Richard Dedekind.

-

**Ernst Mach** (Moravia, Austrian Empire) 1900s who totally abhorred Newton's idea of absolute space and time - Austrian physicist and philosopher, noted for his contributions to physics such as study of shock waves. Quotient of one's speed to that of sound is named the Mach number in his honor. As a philosopher of science, he was a major influence on logical positivism, American pragmatism and through his criticism of Newton, a forerunner of Einstein's relativity.

-

**Hendrik Lorentz** (Netherlands) 1900s - Dutch physicist who shared the 1902 Nobel Prize in Physics with Pieter Zeeman for the discovery and theoretical explanation of the Zeeman effect. He also derived the transformation equations which formed the basis of the special relativity theory of Albert Einstein. According to the biography published by the Nobel Foundation, "It may well be said that Lorentz was regarded by all theoretical physicists as the world's leading spirit, who completed what was left unfinished by his predecessors and prepared the ground for the fruitful reception of the new ideas based on the quantum theory." For this he received many honours and distinctions during his life, including—from 1925 to his death in 1928—the role of Chairman of the exclusive International Committee on Intellectual Cooperation.

-

**Willem De Sitter** (Netherlands) 1920s - Dutch mathematician, physicist, and astronomer. De Sitter made major contributions to the field of physical cosmology. He co-authored a paper with Albert Einstein in 1932 in which they discussed the implications of cosmological data for the curvature of the universe. He also came up with the concept of the de Sitter space and de Sitter universe, a solution for Einstein's general relativity in which there is no matter and a positive cosmological constant. This results in an exponentially expanding, empty universe. De Sitter was also famous for his research on the planet Jupiter.

-

**Alexander Friedmann** (St. Petersburg, Russian Empire) 1920s - was a Russian and Soviet physicist and mathematician. He is best known for his pioneering theory that the universe was expanding, governed by a set of equations he developed now known as the Friedmann equations.

-

Gravitation by Prof. Subhashish Chattopadhyay SKMClasses Bangalore Useful for IIT-JEE, CBSE, I.Sc. PU-II, Boards, CET, CEE, PET, IGCSE IB AP-Physics and other exams

Gravitation by Prof. Subhashish Chattopadhyay SKMClasses Bangalore Useful for IIT-JEE, CBSE, I.Sc. PU-II, Boards, CET, CEE, PET, IGCSE IB AP-Physics and other exams

**Georges Lemaitre** (Belgium) 1920s - was a Belgian priest, astronomer and professor of physics at the Catholic University of Leuven. He proposed the theory of the expansion of the universe, widely misattributed to Edwin Hubble. He was the first to derive what is now known as Hubble's law and made the first estimation of what is now called the Hubble constant, which he published in 1927, two years before Hubble's article. Lemaitre also proposed what became known as the Big Bang theory of the origin of the universe; which he called his "hypothesis of the primeval atom" or the "Cosmic Egg".

-

One of the greatest help we apes got; **was with the discovery or invention of mass spectrometry.**

The men who invented this device were (at least Two; as claimed by the Western English speaking world).

1. Englishman Francis William Aston in 1919
2. Canadian American Arthur Jeffrey Dempster in 1918.

Just imagine as Europe was involved in one of their bloodiest slaughter and carnage, these men were quietly working in their labs devising an instrument that could sort out atoms and ions based on their charge to mass ratio.

( I wish to emphasize yet again that even though atoms are a fact, we using the term atomic theory till date. )

By 1919, Aston had achieved 2 feats:

1. He showed that atoms of a single element could have different isotopes thereby establishing as fact that even non radioactive elements have isotopes.
2. He had invented the first mass spectroscopy.

The Canadian Dempster had greatly improved on it, greatly increasing its accuracy in identifying compounds by mass of elements in a sample. This was a gigantic step to our understanding of nature.

-

**David Goldberg** - David Edward Goldberg ( born September 26, 1953) is an American computer scientist, civil engineer, and professor at the department of Industrial and Enterprise Systems Engineering (IESE) at the University of Illinois at Urbana-Champaign and is most noted for his work in the field of genetic algorithms. He is the director of the Illinois Genetic Algorithms Laboratory (IlligAL) and the chief scientist of Nextumi Inc. He is the author of Genetic Algorithms in Search, Optimization and Machine Learning, one of the most cited books in computer science.

Gravitation by Prof. Subhashish Chattopadhyay SKMClasses Bangalore Useful for IIT-JEE, CBSE, I.Sc. PU-II, Boards, CET, CEE, PET, IGCSE IB AP-Physics and other exams

Gravitation by Prof. Subhashish Chattopadhyay SKMClasses Bangalore Useful for IIT-JEE, CBSE, I.Sc. PU-II, Boards, CET, CEE, PET, IGCSE IB AP-Physics and other exams

In computer science and operations research, a genetic algorithm (GA) is a metaheuristic inspired by the process of natural selection that belongs to the larger class of evolutionary algorithms (EA). Genetic algorithms are commonly used to generate high-quality solutions to optimization and search problems by relying on bio-inspired operators such as mutation, crossover and selection.

-

**Lotfi Zadeh** - The term fuzzy logic was introduced with the 1965 proposal of fuzzy set theory by Lotfi Zadeh. Fuzzy logic had however been studied since the 1920s, as infinite-valued logic—notably by Łukasiewicz and Tarski. Fuzzy logic is a form of many-valued logic in which the truth values of variables may be any real number between 0 and 1, considered to be "fuzzy". By contrast, in Boolean logic, the truth values of variables may only be 0 or 1, often called "crisp" values. Fuzzy logic has been applied to many fields, from control theory to artificial intelligence.

-

**Warren McCulloch and Walter Pitts** - (1943) created a computational model for neural networks based on mathematics and algorithms called threshold logic. This model paved the way for neural network research to split into two distinct approaches. One approach focused on biological processes in the brain and the other focused on the application of neural networks to artificial intelligence.

In the late 1940s psychologist **Donald Hebb** created a hypothesis of learning based on the mechanism of neural plasticity that is now known as **Hebbian learning**. Hebbian learning is considered to be a 'typical' unsupervised learning rule and its later variants were early models for long term potentiation. Researchers started applying these ideas to computational models in 1948 with Turing's B-type machines.

**Farley and Wesley A. Clark** (1954) first used computational machines, then called "calculators," to simulate a Hebbian network at MIT. Other neural network computational machines were created by Rochester, Holland, Habit, and Duda (1956).

**Frank Rosenblatt** (1958) created the perceptron, an algorithm for pattern recognition based on a two-layer computer learning network using simple addition and subtraction. With mathematical notation, Rosenblatt also described circuitry not in the basic perceptron, such as the exclusive-or circuit, a circuit which could not be processed by neural networks until after the backpropagation algorithm was created by Paul Werbos (1975).

Neural network research stagnated after the publication of machine learning research by Marvin Minsky and **Seymour Papert** (1969), who discovered two key issues with the computational machines that processed neural networks. The first was that basic perceptrons were incapable of processing the exclusive-or circuit. The second significant issue was that computers didn't have enough processing power to effectively handle the long run time

Gravitation by Prof. Subhashish Chattopadhyay SKMClasses Bangalore Useful for IIT-JEE, CBSE, I.Sc. PU-II, Boards, CET, CEE, PET, IGCSE IB AP-Physics and other exams

Gravitation by Prof. Subhashish Chattopadhyay SKMClasses Bangalore Useful for IIT-JEE, CBSE, I.Sc. PU-II, Boards, CET, CEE, PET, IGCSE IB AP-Physics and other exams

required by large neural networks. Neural network research slowed until computers achieved greater processing power.

-

**Interval arithmetic, interval mathematics, interval analysis, or interval computation**, is a method developed by mathematicians since the 1950s and 1960s, as an approach to putting bounds on rounding errors and measurement errors in mathematical computation and thus developing numerical methods that yield reliable results. Very simply put, it represents each value as a range of possibilities. For example, instead of estimating the height of someone using standard arithmetic as 2.0 meters, using interval arithmetic we might be certain that that person is somewhere between 1.97 and 2.03 meters. In mathematics, a (real) interval is a set of real numbers with the property that any number that lies between two numbers in the set is also included in the set. For example, the set of all numbers  $x$  satisfying  $0 \leq x \leq 1$  is an interval which contains 0 and 1, as well as all numbers between them.

This concept is suitable for a variety of purposes. The most common use is to keep track of and handle rounding errors directly during the calculation and of uncertainties in the knowledge of the exact values of physical and technical parameters. The latter often arise from measurement errors and tolerances for components or due to limits on computational accuracy. Interval arithmetic also helps find reliable and guaranteed solutions to equations and optimization problems.

-

### **Nassim Nicholas Taleb and Benoit Mandelbrot** -

Nassim is a Lebanese-American essayist, scholar, statistician, former trader, and risk analyst, whose work focuses on problems of randomness, probability, and uncertainty. His 2007 book *The Black Swan* was described in a review by the *Sunday Times* as one of the twelve most influential books since World War II. He advocates what he calls a "black swan robust" society, meaning a society that can withstand difficult-to-predict events.

**Benoit Mandelbrot** was a Polish-born, French and American mathematician with broad interests in the practical sciences, especially regarding what he labeled as "the art of roughness" of physical phenomena and "the uncontrolled element in life." He referred to himself as a "fractalist". He is recognized for his contribution to the field of fractal geometry, which included coining the word "fractal", as well as developing a theory of "roughness and self-similarity" in nature. He spent most of his career in both the United States and France, having dual French and American citizenship. In 1958, he began a 35-year career at IBM, where he became an IBM Fellow, and periodically took leaves of absence to teach at Harvard University. Because of his access to IBM's computers, Mandelbrot was one of the first to use computer graphics to create and display fractal geometric images, leading to his discovering the Mandelbrot set in 1979. He showed how visual complexity can be created from simple rules. He said that things typically considered to be "rough", a "mess" or "chaotic", like clouds or shorelines, actually had a "degree of order." His math and geometry-centered research

Gravitation by Prof. Subhashish Chattopadhyay SKMClasses Bangalore Useful for IIT-JEE, CBSE, I.Sc. PU-II, Boards, CET, CEE, PET, IGCSE IB AP-Physics and other exams

Gravitation by Prof. Subhashish Chattopadhyay SKMClasses Bangalore Useful for IIT-JEE, CBSE, I.Sc. PU-II, Boards, CET, CEE, PET, IGCSE IB AP-Physics and other exams

career included contributions to such fields as statistical physics, meteorology, hydrology, geomorphology, anatomy, taxonomy, neurology, linguistics, information technology, computer graphics, economics, geology, medicine, cosmology, engineering, chaos theory, econophysics, metallurgy, taxonomy and the social sciences.

[Nassim, Benoit Mandelbrot and many others showed that application of Fractals / Mandelbrot is better to predict several practical outcomes, in contrast to Gaussian distribution analysis.](#)

-

**Charles Darwin** told his friend that, he guesses; Life may have started in a shallow hot pond. Darwin was many hundred years ahead of his times.

The Murchison meteorite that fell near Murchison, Victoria, Australia in 1969 was found to contain over 90 different amino acids, nineteen of which are found in Earth life. Comets and other icy outer-solar-system bodies are thought to contain large amounts of complex carbon compounds (such as tholins) formed by these processes, darkening surfaces of these bodies.

The early Earth was bombarded heavily by comets, possibly providing a large supply of complex organic molecules along with the water and other volatiles they contributed.

The University of Waterloo and University of Colorado conducted simulations in 2005 that indicated that the early atmosphere of Earth could have contained up to 40 percent hydrogen—implying a much more hospitable environment for the formation of prebiotic organic molecules. The escape of hydrogen from Earth's atmosphere into space may have occurred at only one percent of the rate previously believed based on revised estimates of the upper atmosphere's temperature.

Researchers at the Rensselaer Polytechnic Institute in New York reported the possibility of oxygen available around 4.3 billion years ago. Their study reported in 2011 on the assessment of Hadean zircons from the earth's interior (magma) indicated the presence of oxygen traces similar to modern-day lavas.

700 Million years after Earth's origin, ( around 3.8 Billion years ago ), the Rocks have signatures of Microbe Life. Just 540 million year ago diversity of life happened ( Cambrian Explosion ). So for almost 3 Billion years Earth had only Microbes. The day was around 22 hours then, as Earth was rotating quicker.

Studies have been made of the amino acid composition of the products of "old" areas in "old" genes, defined as those that are found to be common to organisms from several widely separated species, assumed to share only the last universal ancestor (LUA) of all extant species. These studies found that the products of these areas are enriched in those amino acids that are also most readily produced in the Miller-Urey experiment. This suggests that the original genetic code was based on a smaller number of amino acids - only those available in prebiotic nature - than the current one.

Gravitation by Prof. Subhashish Chattopadhyay SKMClasses Bangalore Useful for IIT-JEE, CBSE, I.Sc. PU-II, Boards, CET, CEE, PET, IGCSE IB AP-Physics and other exams

Gravitation by Prof. Subhashish Chattopadhyay SKMClasses Bangalore Useful for IIT-JEE, CBSE, I.Sc. PU-II, Boards, CET, CEE, PET, IGCSE IB AP-Physics and other exams

Cyanobacteria are able to survive extreme conditions. They live in Antarctica as well as in mountain springs. One species was isolated even from polar bear hairs.

Cyanobacteria get their name from the bluish pigment phycocyanin, which they use to capture light for photosynthesis as they also contain chlorophyll. Their name comes from the Greek word for blue, cyanos. Cyanobacteria have been living on the Earth for more than 3 billion years. They alter genetically and develop various evolutionary lines. They have survived here for a uniquely long time. These are microscopic, they are rich in chemical diversity. The chloroplast in plants is a symbiotic cyanobacterium, taken up by a green algal ancestor of the plants sometime in the Precambrian. These bacteria are often found growing on greenhouse glass, or around sinks and drains. The Red Sea gets its name from occasional blooms of a reddish species of *Oscillatoria*, and African flamingos get their pink color from eating *Spirulina*.

The scientific community has gained a clearer understanding of the evolution of cyanobacteria of the *Synechococcus* group. It is one of the largest groups of cyanobacteria, widespread from the poles to the equator, in the sea as well as on land. Petr Dvorák, a phycologist from the Faculty of Science, has compared their genes and constructed, with the help of molecular biology, the first complex phylogenetic tree of this group, an interpretation of its evolution.

It shows that; the beginning of life, coincides with a hypothetical event that occurred 4 billion to 3.85 billion years ago, known as the Late Heavy Bombardment, in which asteroids pummeled Earth and the solar system's other inner planets. These impacts may have provided the energy to jumpstart the chemistry of life.

Studies suggest that asteroid impacts may break down formamide – a molecule thought to be present in early Earth's atmosphere – into genetic building blocks of DNA and its cousin RNA, called nucleobases.

Chemist Svatopluk Civiš, of the Academy of Sciences of the Czech Republic, and his colleagues used a high-powered laser to break down ionized formamide gas, or plasma, to mimic an asteroid strike on early Earth. The reaction produced scalding temperatures of up to 4,230 degrees Celsius, sending out a shock wave and spewing intense ultraviolet and X-ray radiation. The chemical fireworks produced four of the nucleobases that collectively make up DNA and RNA: adenine, guanine, cytosine and uracil.

The Amino acids joinup to make various Proteins. These lead to microbes. Stromatolites produced Oxygen, and increased the Oxygen content in the atmosphere over Billion years. The Oxygen also made Iron oxide out of Iron dissolved in Water, which deposited as layers of Iron ore.

See about Trilobites at <https://research.amnh.org/paleontology/trilobite-website/twenty-trilobite-fast-facts>

[http://www.fossilmuseum.net/Tree\\_of\\_Life/Stromatolites.htm](http://www.fossilmuseum.net/Tree_of_Life/Stromatolites.htm)

Gravitation by Prof. Subhashish Chattopadhyay SKMClasses Bangalore Useful for IIT-JEE, CBSE, I.Sc. PU-II, Boards, CET, CEE, PET, IGCSE IB AP-Physics and other exams



Gravitation by Prof. Subhashish Chattopadhyay SKMClasses Bangalore Useful for IIT-JEE, CBSE, I.Sc. PU-II, Boards, CET, CEE, PET, IGCSE IB AP-Physics and other exams

<http://jrscience.wcp.muohio.edu/fieldcourses01/PapersMarineEcologyArticles/Stromatolites-TheLongestl.html>

Dvorák and his colleagues utilised also a genome sequence of a new genus of cyanobacteria found in a peatbog in Slovakia. It was named Neosynechococcus. Algology (from algae) is a branch of biology studying algae and cyanobacteria. It deals with the systematisation, phylogenesis, and ecology of these organisms. It also includes physiology, biochemistry, and genetics.

See <https://www.youtube.com/watch?v=SOGwoFkPtT8>

The Miller-Urey experiment was a chemical experiment that simulated the conditions thought at the time to be present on the early Earth, and tested the chemical origin of life under those conditions. Earth favoured chemical reactions that synthesized more complex organic compounds from simpler inorganic precursors. Considered to be the classic experiment investigating abiogenesis, it was conducted in 1952 by Stanley Miller, with assistance from Harold Urey, at the University of Chicago and later the University of California, San Diego. Scientists examining sealed vials preserved from the original experiments ( of Stanley Miller ) were able to show that there were actually well over 20 different amino acids produced in Miller's original experiments.

See <https://www.youtube.com/watch?v=57mertelsBc>

In 1961, Joan Oró found that the nucleotide base adenine could be made from hydrogen cyanide (HCN) and ammonia in a water solution. His experiment produced a large amount of adenine, the molecules of which were formed from 5 molecules of HCN. Also, many amino acids are formed from HCN and ammonia under these conditions. Experiments conducted later showed that the other RNA and DNA nucleobases could be obtained through simulated prebiotic chemistry with a reducing atmosphere.

See <https://www.youtube.com/watch?v=xyhZcEY5PCQ>

Next Study Evolution

- [http://evolution.berkeley.edu/evolibrary/article/side\\_0\\_0/origsoflife\\_05](http://evolution.berkeley.edu/evolibrary/article/side_0_0/origsoflife_05)

<https://www.youtube.com/watch?v=QqG01ihQjoo>

-

Gravitation by Prof. Subhashish Chattopadhyay SKMClasses Bangalore Useful for IIT-JEE, CBSE, I.Sc. PU-II, Boards, CET, CEE, PET, IGCSE IB AP-Physics and other exams

**Craig Venter** and his team of Nobel Laureates, and other very smart Scientists, have been working on Artificial or Synthetic life for long.

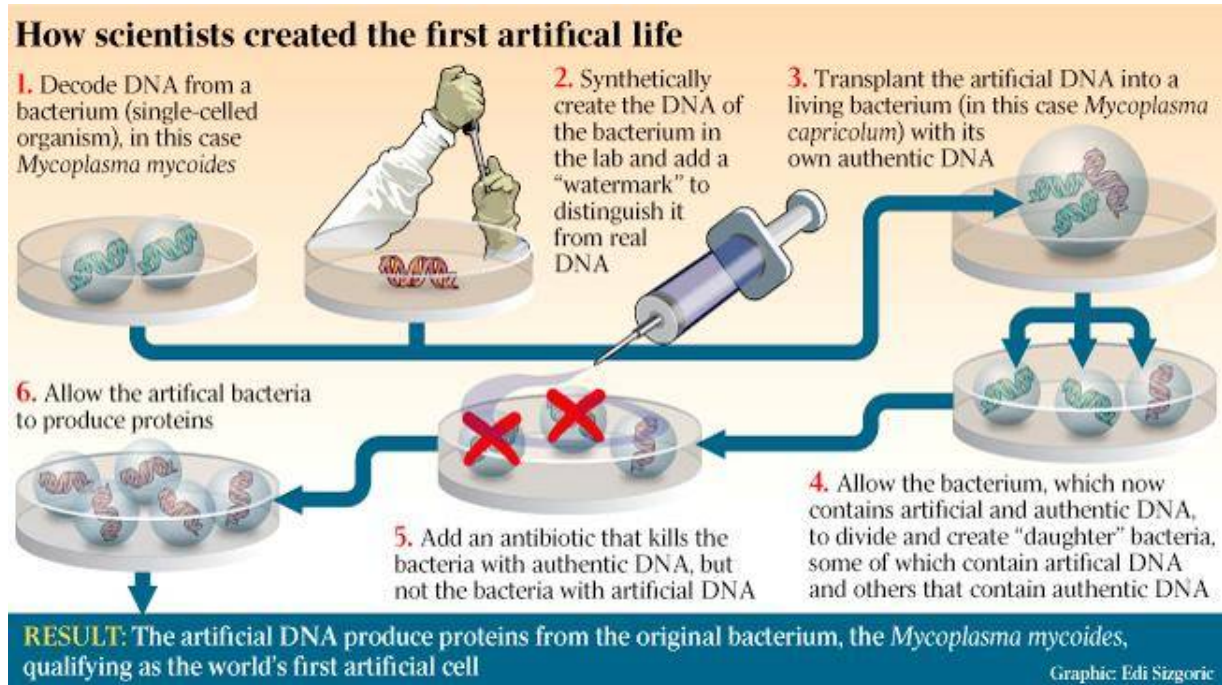

# HOW TO MAKE ARTIFICIAL LIFE

**1** Entire DNA of *Mycoplasma mycoides*, a bug that usually infects goats, is decoded.

**2** Researchers buy fragments of DNA from a mail order catalogue. Each of the four bottles of chemicals contains a section of the code.

**3** The fragments are put into yeast, which 'stitches' them together, gradually building a synthetic copy of the original DNA.

**4** The artificial DNA is put into a recipient bacterium, which then grows and divides, creating two daughter cells, one with the artificial DNA and one with the natural DNA.

**5** Antibiotics in the petri dish kill the bacterium with the natural DNA, leaving the one with the synthetic DNA to multiply.

**6** Within just a few hours, all traces of the recipient bug are wiped out and bugs with artificial DNA thrive. New life has been created.

**7** Possible uses are bugs capable of producing clean fuels and sucking carbon dioxide out of the atmosphere. Also microbes capable of mopping up oil slicks (above) or generating drugs, including the flu vaccine.

Maverick: Dr Craig Venter

Graphic by John Lawson

Gravitation by Prof. Subhashish Chattopadhyay SKMClasses Bangalore Useful for IIT-JEE, CBSE, I.Sc. PU-II, Boards, CET, CEE, PET, IGCSE IB AP-Physics and other exams

See <https://www.youtube.com/watch?v=ayfF1v7rifw>

-

**Gordon Allport and S. Odbert** - The OCEAN model of "Big Five personality traits", rather modern Psychology was started by these two Men. The Big Five personality traits, also known as the five factor model (FFM), is a model based on common language descriptors of personality (lexical hypothesis). These descriptors are grouped together using a statistical technique called factor analysis (i.e. this model is not based on experiments). This widely examined theory suggests five broad dimensions used by some psychologists to describe the human personality and psyche. The five factors have been defined as openness to experience, conscientiousness, extraversion, agreeableness, and neuroticism, often listed under the acronyms OCEAN or CANOE. Beneath each proposed global factor, a number of correlated and more specific primary factors are claimed. For example, extraversion is said to include such related qualities as gregariousness, assertiveness, excitement seeking, warmth, activity, and positive emotions.

In 1884, Sir Francis Galton was the first person who is known to have investigated the hypothesis that it is possible to derive a comprehensive taxonomy of human personality traits by sampling language: the lexical hypothesis. In 1936, Gordon Allport and S. Odbert put Sir Francis Galton's hypothesis into practice by extracting 4,504 adjectives which they believed were descriptive of observable and relatively permanent traits from the dictionaries at that time. In 1940, Raymond Cattell retained the adjectives, and eliminated synonyms to reduce the total to 171. He constructed a self-report instrument for the clusters of personality traits he found from the adjectives, which he called the Sixteen Personality Factor Questionnaire. Based on a subset of only 20 of the 36 dimensions that Cattell had originally discovered, Ernest Tupes and Raymond Christal claimed to have found just five broad factors which they labeled: "surgency", "agreeableness", "dependability", "emotional stability", and "culture". Warren Norman subsequently relabeled "dependability" as "conscientiousness".

After "**God, Puja & Prayer**", being the 1<sup>st</sup> ; the 2<sup>nd</sup> worst illusion, that hampers Science; is "**Gut feeling**". The Havoc or mayhem of "Gut feeling" is very prominently seen regarding Psychology, or People skills ( of most people ). Close to 99% people conduct interviews and take 'people decisions', without caring anything about Psychology.

Long back I wrote "**Millions of Interviews are being conducted every day, where the interviewer knows nothing about Psychology, while believes that her gut feeling is guiding for correct decisions**". [ [the reader will have to agree with this, if he heard about OCEAN model for the first time, here](#) ]

<https://zookeepersblog.wordpress.com/interview-techniques-and-the-things-you-cannot-find/>

<https://zookeepersblog.wordpress.com/are-people-very-logical-and-rational-then-why-should-we-be-polite-with-all/>

Gravitation by Prof. Subhashish Chattopadhyay SKMClasses Bangalore Useful for IIT-JEE, CBSE, I.Sc. PU-II, Boards, CET, CEE, PET, IGCSE IB AP-Physics and other exams

Gravitation by Prof. Subhashish Chattopadhyay SKMClasses Bangalore Useful for IIT-JEE, CBSE, I.Sc. PU-II, Boards, CET, CEE, PET, IGCSE IB AP-Physics and other exams

<https://zookeepersblog.wordpress.com/correlated-adjectives-this-personality-trait-predicts-your-tendency-to-lie-and-cheat/>

Psychology stands on the conclusions drawn after experiments. Some most important experiments being Milgram Experiment, Stanford Prison experiment, Hawthorne experiment, Bad Samaritan experiment, Attractiveness experiments, Evolutionary Psychology experiment, Decoy experiments, Equity theory of Motivation experiments, etc ...

The experiments that I used to talk about while teaching **Senior Corporate Managers** are listed at

<https://zookeepersblog.wordpress.com/psychology-experiments-and-summary-of-the-subject/>

-

## Is Economics a Branch of Science ?

Not discussing about Economists here, as my personal opinion about, "works and contribution of Economists" is very poor. All of them argue and fancy in disagreeing with each and every thing told by someone. Economics has no consensus, no agreed rules, driven more by politics, and / or dynamic situations. No prediction by any Economist comes Correct or True; consistently. Media interviews thousands of these "strange foolish guys", and trys to "understand" an average. Randomly someone's prediction matches the actual outcome, and Predictions of 999 of the other **morons** deviate. These guys are always busy, analyzing and confirming that in past what had happened was "**inevitable**", while in the same breath, they accept that "no clue about the future". **None** had predicted the "**inevitable**" though.

Personally I have read several books in Economics, and several thousand ( may be more than 10,000 ) scholarly articles. All will call me a fool, for every prediction; I make on Economy, or anything in Economics. As usual no one will agree with me, I know. I never try to talk about Economics, as you all saw, here, just now! I agreed with Millions of others, '**to Not to**' believe in anything an Economist says or predicts.

A very small "summary" of what these 'idiots' have done is at

<https://zookeepersblog.wordpress.com/a-butcher-makes-kima-of-economics/>

[ My friends occasionally say ... "**even Russia has Russian economists**" ... ]

Nassim Taleb has called for cancellation of the Nobel Prize in Economics, saying that the damage from economic theories can be devastating. ( and I agree with him ).

-

Gravitation by Prof. Subhashish Chattopadhyay SKMClasses Bangalore Useful for IIT-JEE, CBSE, I.Sc. PU-II, Boards, CET, CEE, PET, IGCSE IB AP-Physics and other exams

Gravitation by Prof. Subhashish Chattopadhyay SKMClasses Bangalore Useful for IIT-JEE, CBSE, I.Sc. PU-II, Boards, CET, CEE, PET, IGCSE IB AP-Physics and other exams

In contrast to economics, Finance Law/Rules and Marketing Tricks/Techniques are supreme. Very correctly Millions call these subjects as "Financial Science" and "Marketing Science".

The learning's here are generally not attributed to a particular person. There are many Key concepts, which are correct; and accurate! These enable people to take right decisions, to make money, be profitable, to generate employment, to avoid and reduce loss, to sale, and keep businesses going.

For whatever we do, we have to deal with people, and earn money or make profit. So the basic understanding of Psychology, the Laws of Finance, and the 'Tricks and trades' of Marketing ( Science ) are must for all. Human beings in general, harbor many limitations; which Economists disregard. One of the first assumptions of Economics, "The Rational Human beings" is wrong.

See the list of Biases at <http://skmclasses.kinja.com/bias-we-all-are-biased-1761664826>

Some of the key concepts of Finance are NPV ( Net Present Value ), ROI ( Return on Investment ), Risk/Return Tradeoff, Diversification, ROCE ( Return on Capital Employed ), Discounted Cash flow, Time value of Money, Liquidity, Budgeting etc. The list is big. It takes many months of correct studies, to understand and master these. Those who apply these rules and learning's well; are paid well. People in general do not disagree to fight with what Finance Gurus says.

Marketing Science is Art. Successful Marketing gurus are paid very well. I have not seen insults and fights, with what Marketing Gurus do. There are some key concepts.

See <https://zookeepersblog.wordpress.com/25-points-on-brand-and-marketing/>

Personally I will always remain a toddler, regarding Tricks and details of Marketing.

When I was in Standard 9, my Aunt ( Cousin sister of my Mom ), started a very small chemical business. She was staying in a different city, and I "managed" the business affairs, in Jamshedpur. I had to meet lot of people at various offices, advertise, give sale pitches, sale, follow-up with people, get payments, and generate profit etc.

This gave me very interesting exposure to human behavior, organizations, processes, human nature and follies, greed etc. Much later I managed my own IIT JEE coaching / Business.

With this background, I am adding "**a Pinch of Salt**" in the Ocean of Management.

[ meaning, I do not think this is going to teach or contribute anything ]

Regarding advertisement, I have observed that people are in silos, or islands. Mostly unaware what is going on in other islands. People expect advertisement in their own silo, or island. So advertisement is required to be done in multiple mediums / channels. If I advertise in newspaper, ( [say about Govt. of India, official Olympiads](#) ), some people will say ... "school did not tell anything". If I advertise in Google adwords, guys in Facebook will not know. Any

Gravitation by Prof. Subhashish Chattopadhyay SKMClasses Bangalore Useful for IIT-JEE, CBSE, I.Sc. PU-II, Boards, CET, CEE, PET, IGCSE IB AP-Physics and other exams

Gravitation by Prof. Subhashish Chattopadhyay SKMClasses Bangalore Useful for IIT-JEE, CBSE, I.Sc. PU-II, Boards, CET, CEE, PET, IGCSE IB AP-Physics and other exams

amount of "Radio Messages" done, will not stop people saying ... "the CSR ( corporate Social responsibility ) department did not send any mailer ! ...

It is extremely costly to advertise in every island. Small businesses just cannot afford such expenditures. So advertisement always remains insufficient, as per my perception. Effectiveness of the advertisement, and success is always unknown. As per my perception, the young MBA's handling the budget randomly try various things, playing randomly with "others money". Randomly there is some result/response, that is termed / "show cased" as success. Gurus handling crores of advertisement budget will have their own "correct" experience. 99.99% people / small businesses are not relevant in that.

[ [Google adwords in my experience / observation is very costly, and zero effective. Absolute waste of money. Facebook in contrast maintains lots of connections, the visitors repeat of their own, so much more persistent.](#) ]

As per my perception; Advertisement is not a communication, at all. It is an enabler, so that **if someone searches**, then can find the links / details quickly. Only those who search, if they get some details, of something; earlier than another; the former has higher chance being considered.

[ Did you notice that top 50 or 100 Management Gurus, and / or "Best selling Management Books" are not Indian ]

-

Science is closely related to Technology. I personally cannot distinguish.

3D Printing was started by Chuck Hull



Gravitation by Prof. Subhashish Chattopadhyay SKMClasses Bangalore Useful for IIT-JEE, CBSE, I.Sc. PU-II, Boards, CET, CEE, PET, IGCSE IB AP-Physics and other exams

Gravitation by Prof. Subhashish Chattopadhyay SKMClasses Bangalore Useful for IIT-JEE, CBSE, I.Sc. PU-II, Boards, CET, CEE, PET, IGCSE IB AP-Physics and other exams

As of 2016 ( apart from Lakhs of Industrial Applications ) Body-parts are being 3D printed

See <https://www.youtube.com/watch?v=a1lkv3yHs0w>

And [https://www.youtube.com/watch?v=\\_RO5DSIB1GE](https://www.youtube.com/watch?v=_RO5DSIB1GE)

-

Xenotransplantation

<https://www.youtube.com/watch?v=6rKUBBjaa0g>

<https://www.youtube.com/watch?v=qFOo28AahAE>

-

Artificial Blood

Since 1990s various kinds of Artificial Blood has been made. I read many reports! Research to improve is always on.

<https://www.youtube.com/watch?v=9I7oUuZBG4c>

-

Artificial Photosynthesis or Chlorophyll

<https://www.youtube.com/watch?v=hU-T0ht2OdQ>

<https://www.youtube.com/watch?v=N8LHqoNber4>

-

Nanotechnology

<https://www.youtube.com/watch?v=xIYlex2TF5g>

<https://www.youtube.com/watch?v=7hRjhxix2uL0>

-

Metamaterials

<https://www.youtube.com/watch?v=taSfueSfmag>

[https://www.youtube.com/watch?v=26J5n\\_8\\_6TQ](https://www.youtube.com/watch?v=26J5n_8_6TQ)

-

Molecular Motors

<https://www.youtube.com/watch?v=WH5rwsu5tzl>

Gravitation by Prof. Subhashish Chattopadhyay SKMClasses Bangalore Useful for IIT-JEE, CBSE, I.Sc. PU-II, Boards, CET, CEE, PET, IGCSE IB AP-Physics and other exams



Gravitation by Prof. Subhashish Chattopadhyay SKMClasses Bangalore Useful for IIT-JEE, CBSE, I.Sc. PU-II, Boards, CET, CEE, PET, IGCSE IB AP-Physics and other exams

Quantum Computer

<https://www.youtube.com/watch?v=0dXNmbiGPS4>

<https://www.youtube.com/watch?v=u9zx7QOKPno>

-

For list of emerging Technologies see

[https://en.wikipedia.org/wiki/List\\_of\\_emerging\\_technologies](https://en.wikipedia.org/wiki/List_of_emerging_technologies)

-

The list can go on forever. Students can read and learn more of their own...

-

Even though Indian Rocket could send 20 Satellites to space in one go, Indian prefer to do the following ...



Every Puja is remnant of "Caste System". Who are performing the Pujas ? What is the Qualification of the Pujari ? What is his effectiveness ? How are the Pujaris chosen ?

Russian Dnepr rocket had sent 37 satellites to Space, without Pujas !

Gravitation by Prof. Subhashish Chattopadhyay SKMClasses Bangalore Useful for IIT-JEE, CBSE, I.Sc. PU-II, Boards, CET, CEE, PET, IGCSE IB AP-Physics and other exams

Gravitation by Prof. Subhashish Chattopadhyay SKMClasses Bangalore Useful for IIT-JEE, CBSE, I.Sc. PU-II, Boards, CET, CEE, PET, IGCSE IB AP-Physics and other exams

I have met lot of people who think, that "Global Warming" is happening due to Cars, or because of burning Plastics ...

In our atmosphere close to 1% is Argon, while only 0.04% in CO<sub>2</sub>

Half of the world's oxygen is produced via phytoplankton photosynthesis. The other half is produced via photosynthesis on land by trees, shrubs, grasses, and other plants.

See [http://news.nationalgeographic.com/news/2004/06/0607\\_040607\\_phytoplankton.html](http://news.nationalgeographic.com/news/2004/06/0607_040607_phytoplankton.html)

See <http://skmclasses.kinja.com/global-warming-is-not-due-to-human-activity-1761784651>

My students and the readers of this book must know that; over the past 250 years, humans have added just one part of CO<sub>2</sub> in 10,000 to the atmosphere. One volcanic cough can do this in a day. <https://www.skepticalscience.com/print.php?r=50>

<http://time.com/3698572/science-maya-tolstoy-geophysical-research-letters-volcanoes-climate-change/>

Temperature-Sea Levels-CO<sub>2</sub>-etc always have been fluctuating over ages - Global Warming

See

<https://archive.org/details/TemperatureSeaLevelsCO2EtcAlwaysHaveBeenFluctuatingOverAgesGlobalWarming>

-

Know about the Giants of Science from Videos

<https://archive.org/details/CasimirPolderDaviesUnruhBELLAspectGalileoMosleyChadwickFeynmanSchrodinger>

<https://www.youtube.com/watch?v=ecQazN9Z24w>

Gravitation by Prof. Subhashish Chattopadhyay SKMClasses Bangalore Useful for IIT-JEE, CBSE, I.Sc. PU-II, Boards, CET, CEE, PET, IGCSE IB AP-Physics and other exams

Gravitation by Prof. Subhashish Chattopadhyay SKMClasses Bangalore Useful for IIT-JEE, CBSE, I.Sc. PU-II, Boards, CET, CEE, PET, IGCSE IB AP-Physics and other exams

### Preface for Physics

Professor H. C. Verma wrote amazing books in Physics. There are many other good books for IIT JEE and other exams. [Krishna's Guides](#), Books by Professor [N. N. Ghosh](#), Professor D. C. Pandey, GRB Publications Physics Guides etc are very good. For numericals the Irodov's books remain the King !

"Concepts of Physics" by Professor H C Verma have been available since 1991. ( and did not change or updated since ). Previous to that, past papers of IIT JEE, and other exams, were the source for preparation. I was in High School in 1980s. I had 6-7 Russian books apart from Irodov. All these were very good. Resnick and Halliday 's ( Walker and Krane came in subsequently ) book was also well known. There were too many " uncles " who used to advice that " only Resnick and Halliday 's book was enough " !

**Well I agreed and disagreed.** There were many IIT JEE questions which were ditto or verbatim picked-up from Resnick Halliday ! **But, something more was always needed.** Brilliant Tutorials, Agarwal Coaching etc, were famous those days. ( 1980s 90 s ). They were giving **several new questions**, which enabled more practice. **People slowly realized that " every type " of questions are NOT there in Resnick & Halliday, or say Irodov.**

Uncles saying " only Resnick and Halliday 's book was enough " ! were wrong. "Concepts of Physics" by Professor H C Verma sold so much because of very good step by step explanations, new solved examples, new exercises. Several gaps were filled-up.

The word Physics is derived from Latin **physica**, from Greek (ta) **phusika**, **(the things) of nature**, from neuter plural of phusikos.

**So, why am I writing "another book" in Physics ? ( The description of nature )**

I wish to answer this most important question, first !

There are many kind of Questions which are **not** covered in " Concepts of Physics " of Professor H. C. Verma. Also Irodov, in his books, **does not** explain or cover several kinds of Problems or Questions. The " Coaching Institutes " very rightly thrived on these gaps. Almost 100% students benefit more **with more examples**. **As Coaching Institutes discuss, cover and repeat several more examples in each chapter compared to School or Text books; explains the reason of their popularity.**

Gravitation by Prof. Subhashish Chattopadhyay SKMClasses Bangalore Useful for IIT-JEE, CBSE, I.Sc. PU-II, Boards, CET, CEE, PET, IGCSE IB AP-Physics and other exams

Let me list a few examples to explain all this.

Optics - 1 ) The expression for deviation of a ray passing through a slab

### ***Refraction through a transparent slab (lateral shift)***

Consider a transparent slab of thickness  $t$ , and refractive index  $n$ . A monochromatic beam of light falls on one side at an angle of incidence  $i$  as shown in Fig. Emergent ray will be parallel to incident ray, but there will be a lateral shift  $S$  of the incident ray. At the first interface,

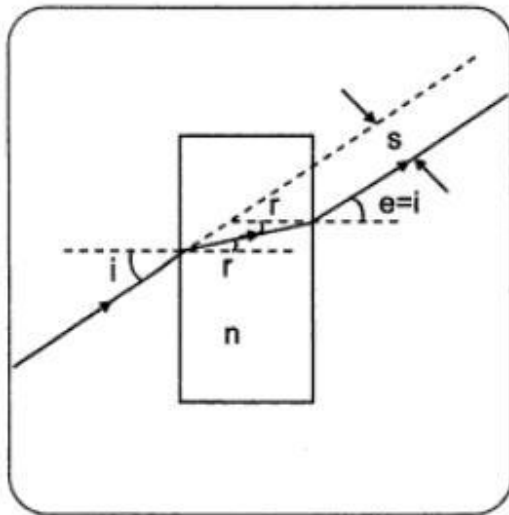

$1 \sin i = n \sin r$  and at the second interface

$n \sin r = 1 \sin e$

where,  $r$  is the angle of refraction at the first interface and  $e$ , the angle of refraction at the second interface.  $\therefore e = i$

From Fig. lateral shift is calculated as follows:

$$AD = t; AB = \frac{AD}{\cos r} = \frac{t}{\cos r}$$

$$\text{Lateral shift } S = BC = AB \sin(i - r) = \frac{t \sin(i - r)}{\cos r}$$

$$\text{i.e., } S = \frac{t \sin(i - r)}{\cos r}$$

It may be noted that  $S_{\max} = t$  for  $i = 90^\circ$  (grazing incidence) and  $S_{\min} = 0$  for  $i = 0$  (normal incidence)

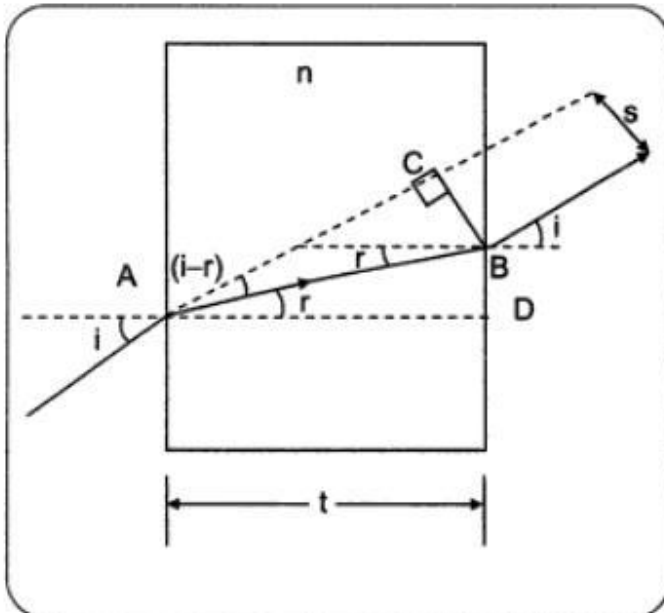

Special case:

(i) **small i**

$$t \frac{\sin(i - r)}{\cos r} = \frac{t[\sin i \cos r - \cos i \sin r]}{\cos r}$$

$$[r \text{ small} \Rightarrow \cos r \approx 1]; i \text{ small} \Rightarrow \cos i \approx 1]$$

$$\therefore S = t(\sin i - \sin r) = t \sin i \left[ 1 - \frac{\sin r}{\sin i} \right]$$

$$\Rightarrow S = t \sin i \left[ 1 - \frac{1}{n} \right] = t i \left( 1 - \frac{1}{n} \right) [i \text{ small} \Rightarrow \sin i = i]$$

$$\Rightarrow S = t i \frac{(n - 1)}{n}$$

(Note: use formula  $S = t \frac{\sin(i - r)}{\cos r}$  unless it is given that  $i = \text{small}$ )

(ii) When  $i$  is not small, it can be shown that

$$S = \frac{t \sin(i - r)}{\cos r} = t \sin i \left[ 1 - \frac{\cos i}{\sqrt{n^2 - \sin^2 i}} \right] \text{ or}$$

$$S = t \sin i \left[ 1 - \sqrt{\frac{1 - \sin^2 i}{n^2 - \sin^2 i}} \right]$$

See again

### Lateral Shift

In the following figure, ray  $MA$  is parallel to ray  $BN$ . But the emergent ray is displaced laterally by a distance  $d$  which depends upon  $\mu$ ,  $t$  and  $i$  and its value is given by

$$d = t \left( 1 - \frac{\cos i}{\sqrt{\mu^2 - \sin^2 i}} \right) \sin i.$$

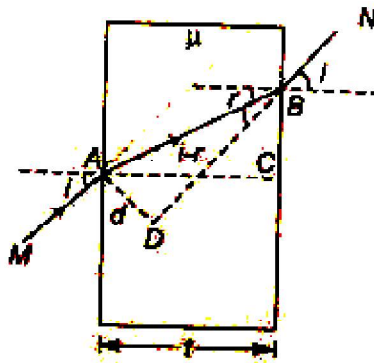

From the figure,  $AB = \frac{AC}{\cos r} = \frac{t}{\cos r}$  (as,  $AC = t$ )

Since,

$$d = AB \sin(i - r)$$

$$= \frac{t}{\cos r} [\sin i \cos r - \cos i \sin r]$$

Further,

$$\mu = \frac{\sin i}{\sin r} \text{ or } \sin r = \frac{\sin i}{\mu}$$

$\therefore$

$$\tan r = \frac{\sin i}{\sqrt{\mu^2 - \sin^2 i}}$$

The expression for  $d$  now is

$$d = \left( \sqrt{1 - \frac{\cos^2 i}{\mu^2 - \sin^2 i}} \right) t \sin i$$

**Note** For small angles of incidence  $d = t \left( \frac{\mu - 1}{\mu} \right)$

A white light is incident at  $20^\circ$  on a material of silicate flint glass slab as shown.  $\mu_{\text{violet}} = 1.66$  and  $\mu_r = 1.6$ . For what value of  $d$  will the separation be 1 mm in red and violet rays.

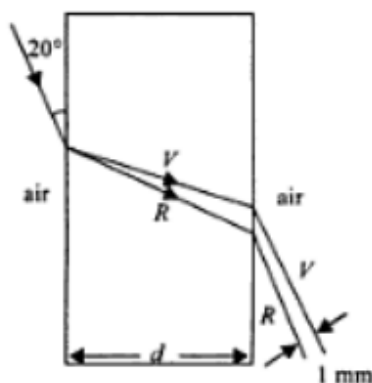

- (a)  $\frac{5}{3}$  cm                      (b)  $\frac{10}{3}$  cm  
 (c) 5 cm                              (d)  $\frac{20}{3}$  cm

**Solution** (b)  $\sin r_1 = \frac{\sin 70}{1.66} = \frac{.9397}{1.66}$  or  $r_1 = 34^\circ 30'$

$$\sin r_2 = \frac{\sin 70}{1.6} = \frac{.9397}{1.6} \text{ or } r_2 = 36^\circ$$

Using  $y = \frac{t \sin(i-r)}{\cos r}$

$$y_1 - y_2 = d \left[ \frac{\sin(i-r_1)}{\cos r_1} - \frac{\sin(i-r_2)}{\cos r_2} \right]$$

$$0.1 = d \left[ \frac{\sin 35^\circ 30'}{\cos 34^\circ 30'} - \frac{\sin 34^\circ}{\cos 36^\circ} \right]$$



Gravitation by Prof. Subhashish Chattopadhyay SKMClasses Bangalore Useful for IIT-JEE, CBSE, I.Sc. PU-II, Boards, CET, CEE, PET, IGCSE IB AP-Physics and other exams

or  $0.1 = d \left[ \frac{0.5807}{0.8241} - \frac{0.5592}{0.8090} \right] = d[0.71 - 0.68]$

or  $d = \frac{0.1}{0.03} = \frac{10}{3} \text{ cm}$

Optics - 2 ) Fresnel's Biprism

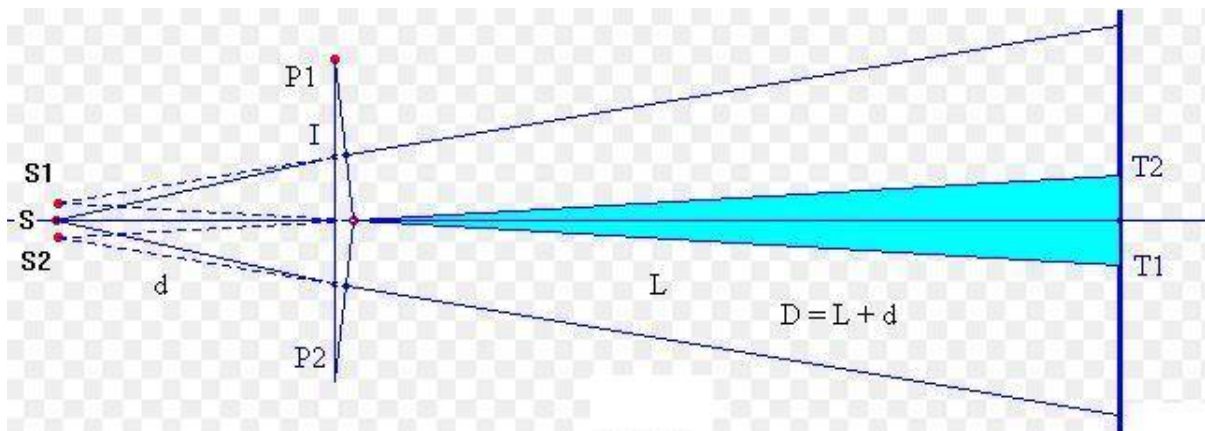
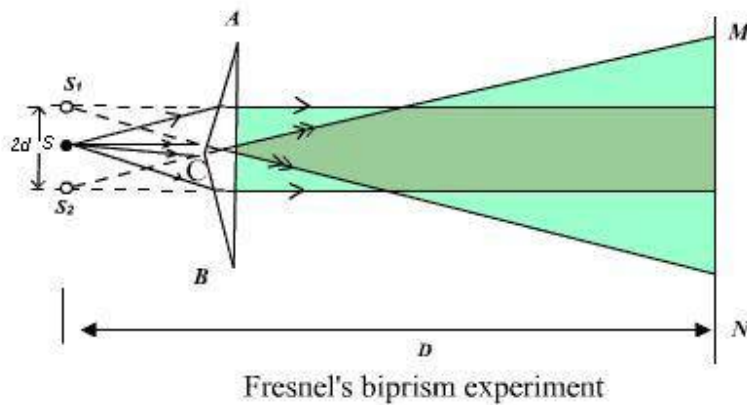
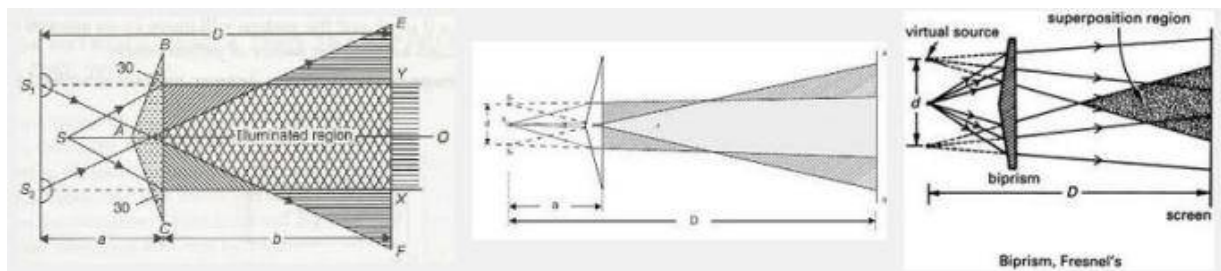

Gravitation by Prof. Subhashish Chattopadhyay SKMClasses Bangalore Useful for IIT-JEE, CBSE, I.Sc. PU-II, Boards, CET, CEE, PET, IGCSE IB AP-Physics and other exams

very small refracting angle  $\alpha$ , is given by  

$$\delta = (\mu - 1)\alpha,$$
 where  $\mu$  is the refractive index of the material of the prism. Note that  $\alpha$  is in radian

It is clear from Fig. that

$$\delta = \frac{d}{a}$$

$$\therefore (\mu - 1)\alpha = \frac{d}{a} \quad \text{or} \quad d = (\mu - 1)\alpha a$$

$$\therefore \quad \boxed{2d = 2(\mu - 1)\alpha a}$$

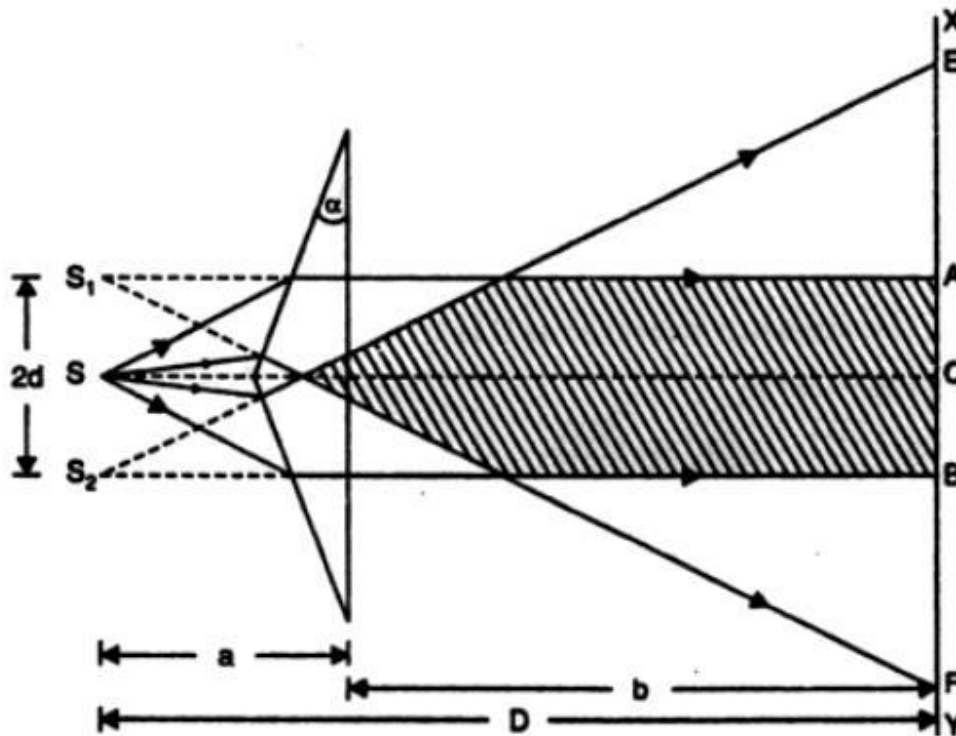
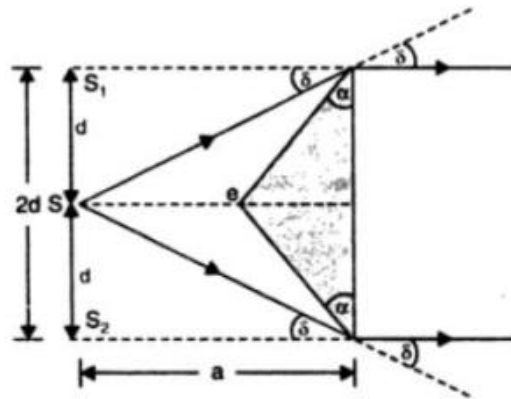

*In a biprism experiment, the eye-piece was placed at a distance of 120 cm from the source. The distance between two virtual images was found equal to 0.075 cm. Find the wavelength of light of source if eye-piece is moved through a distance of 1.888 cm for 20 fringes to cross the field of view.*

$$D = 120 \text{ cm,}$$

$$2d = 0.075 \text{ cm, } \lambda = ?$$

$$\beta = \frac{1.888}{20} \text{ cm}$$

$$\beta = \frac{\lambda D}{2d} \quad \text{or} \quad \lambda = \frac{\beta(2d)}{D} \text{ cm}$$

$$\lambda = \frac{1.888}{20} \times 0.075 \text{ cm}$$

$$= 5900 \times 10^{-8} \text{ cm} = \mathbf{5900 \text{ \AA}}$$

*The inclined faces of a glass prism ( $\mu = 1.5$ ) make an angle of  $1^\circ$  with the base of the prism. The slit is 10 cm from the biprism and is illuminated by light of  $\lambda = 5900 \text{ \AA}$ . Find the fringe width observed at a distance of 1m from the biprism.*

**Solution.**  $\alpha = 1^\circ = \frac{\pi}{180}$  radian,

$$\mu = 1.5,$$

$$D = 10 \text{ cm} + 100 \text{ cm} = 110 \text{ cm,}$$

$$\lambda = 5900 \times 10^{-8} \text{ cm}$$

$$\beta = \frac{D\lambda}{2d} = \frac{D\lambda}{2(\mu - 1)\alpha}$$

or 
$$\beta = \frac{110 \times 5900 \times 10^{-8} \times 7 \times 180}{2(1.5 - 1) 22 \times 10} \text{ cm}$$
$$= \mathbf{0.037 \text{ cm.}}$$

*A biprism is placed 5 cm from a slit illuminated by sodium light ( $\lambda = 5890 \text{ \AA}$ ). The width of the fringes obtained on a screen 75 cm from the biprism is  $9.424 \times 10^{-2} \text{ cm}$ . What is the distance between the two coherent sources ?*

**Solution.**  $D = 5 \text{ cm} + 75 \text{ cm} = 80 \text{ cm}$   
 $\beta = 9.424 \times 10^{-2} \text{ cm}$   
 $2d = ?$

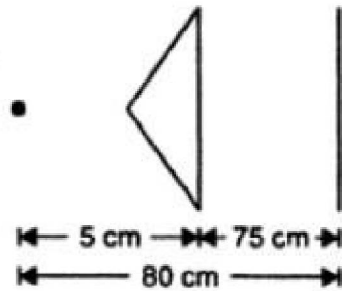

Fig. 2.25

$$\lambda = 5890 \text{ \AA} = 5890 \times 10^{-8} \text{ cm}$$

We know that  $\beta = \frac{\lambda D}{2d}$

or 
$$2d = \frac{\lambda D}{\beta} = \frac{5890 \times 10^{-8} \times 80}{9.424 \times 10^{-2}} \text{ cm}$$
  
$$= 0.05 \text{ cm.}$$

*In a Fresnel's biprism experiment, the fringe width is observed to be 0.087 mm. What will it become if the slit to biprism distance is reduced to  $\frac{3}{4}$  of the original distance ? (all else remaining unchanged).*

**Solution.**  $2d = 2(\mu - 1)\alpha a$  ... (1)

$$2d' = 2(\mu - 1)\alpha \left(\frac{3}{4} a\right) \quad \dots(2)$$

Dividing (2) by (1),  $\frac{2d'}{2d} = \frac{3}{4}$

Again, we know that  $\beta = \frac{D\lambda}{2d}$

$$\frac{\beta'}{\beta} = \frac{2d}{2d'} = \frac{4}{3}$$

or  $\beta' = \frac{4}{3}\beta = \frac{4}{3} \times 0.087 \text{ mm} = \mathbf{0.116 \text{ mm}}$ .

*The inclined faces of biprism of refractive index 1.50 make angles of  $2^\circ$  with its base. A slit illuminated by monochromatic light is placed at a distance of 10 cm from the biprism. If*

**distance between two dark fringes observed at a distance of 1 metre from biprism is 0.18 mm, find the wavelength of light used.**

**Solution.**  $\mu = 1.50,$

$$\alpha = 2^\circ = 2 \times \frac{\pi}{180} = \frac{\pi}{90} \text{ radian,}$$

$$a = 10 \text{ cm, } b = 1 \text{ m} = 100 \text{ cm,}$$

$$\beta = 0.18 \text{ mm} = 0.018 \text{ cm, } \lambda = ?$$

We know that

$$\beta = \frac{D\lambda}{2d}, D = a + b \text{ and } 2d = 2(\mu - 1)\alpha a$$

$$\therefore \beta = \frac{\lambda(a + b)}{2(\mu - 1)\alpha a}$$

$$\therefore \lambda = \frac{2\beta(b - 1)\alpha a}{a + b}$$

$$\begin{aligned} &= \frac{2 \times 0.018 \times (1.50 - 1) \frac{\pi}{90} \times 10}{10 + 100} \text{ cm} \\ &= 5714 \times 10^{-8} \text{ cm} = \mathbf{5714 \text{ \AA}.} \end{aligned}$$

If Fresnel biprism is immersed in a liquid of refractive index  $\mu'$ , then

$$\beta_{\text{new}} = \frac{\frac{\lambda}{\mu'}(a + b)}{2a\left(\frac{\mu}{\mu'} - 1\right)\alpha} = \frac{\lambda(a + b)}{2a(\mu - \mu')\alpha}$$

Gravitation by Prof. Subhashish Chattopadhyay SKMClasses Bangalore Useful for IIT-JEE, CBSE, I.Sc. PU-II, Boards, CET, CEE, PET, IGCSE IB AP-Physics and other exams

Optics - 3 ) Negative Refractive Index. For meta-materials we can have Negative Refractive index. So " Refractive Index " is a ' rare ' scalar which can be negative. [ Recall most scalars are positive, such as volume, mass, pressure, viscosity, resistance, inductance, capacitance etc. **Can you think of a few scalars which can be negative also apart from charge or current ?** ]

Negative refractive index question was asked in 2012 IIT JEE

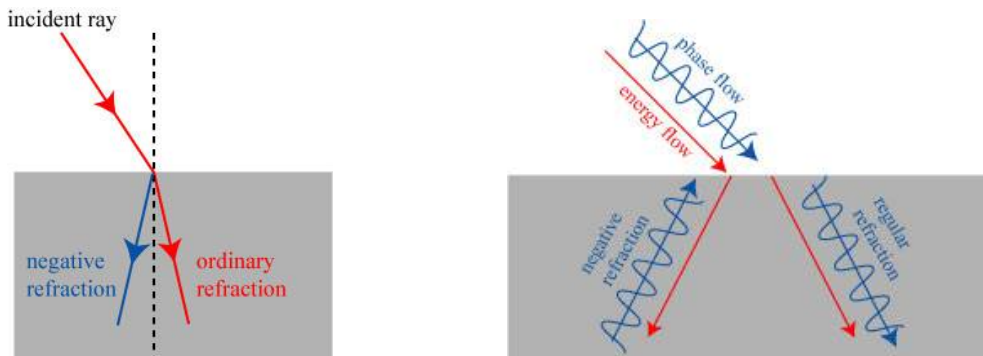

Optics - 4 ) Combination of Prism and Mirror problems

**Find the co-ordinates of image of the point object 'O' formed after reflection from concave mirror as shown in figure assuming prism to be thin and small in size of prism angle  $2^\circ$ . Refractive index of the prism material is  $3/2$ .**

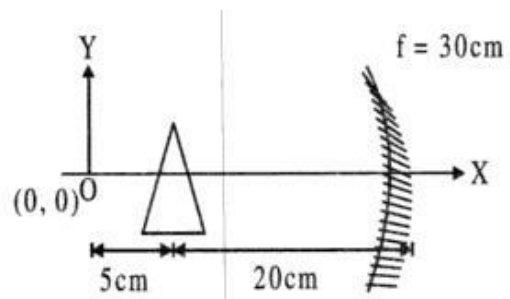

Gravitation by Prof. Subhashish Chattopadhyay SKMClasses Bangalore Useful for IIT-JEE, CBSE, I.Sc. PU-II, Boards, CET, CEE, PET, IGCSE IB AP-Physics and other exams

Consider image formation through prism. All incident rays will be deviated by

$$\delta = (\mu - 1)A = \left(\frac{3}{2} - 1\right)2^\circ = 1^\circ = \frac{\pi}{180} \text{ rad}$$

As prism is thin, object and image will be in the same plane as shown in figure.

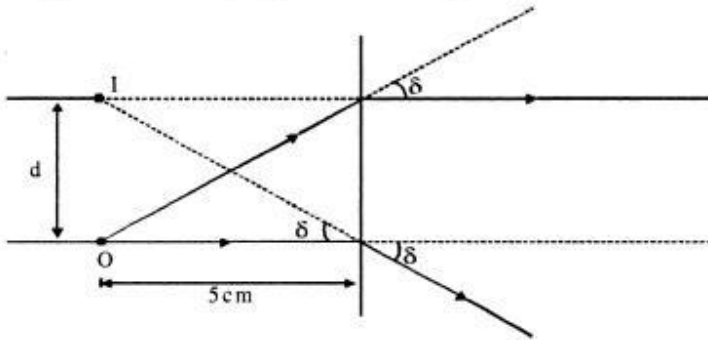

It is clear  $\frac{d}{5} = \tan \delta \approx \delta$  ( $\because \delta$  is very small) or  $d = \frac{\pi}{36} \text{ cm}$

Now this image will act as an object for concave mirror.

$$u = -25 \text{ cm}, f = -30 \text{ cm}, \therefore v = \frac{uf}{u-f} = 150 \text{ cm}, \text{ Also, } m = \frac{-v}{u} = +6$$

$$\therefore \text{Distance of image from principal axis} = \frac{\pi}{36} \times 6 = \frac{\pi}{6} \text{ cm}$$

Hence, co-ordinates of image formed after reflection from concave mirror are

$$\left(175 \text{ cm}, \frac{\pi}{6} \text{ cm}\right)$$

A prism having an apex

angle  $4^\circ$  and refractive index 1.5 is located in front of a vertical plane mirror as shown in figure. Through what total angle is the ray deviated after reflection from the mirror?

(a)  $176^\circ$       (b)  $4^\circ$   
(c)  $178^\circ$       (d)  $2^\circ$



$$\delta_{\text{prism}} = (\mu - 1)A = (1.5 - 1)4^\circ = 2^\circ$$

$$\begin{aligned} \therefore \delta_{\text{total}} &= \delta_{\text{prism}} + \delta_{\text{mirror}} \\ &= (\mu - 1)A + (180 - 2i) \\ &= (1.5 - 1)4^\circ + (180 - 2 \times 2^\circ) \\ &= 2^\circ + 176^\circ = 178^\circ \end{aligned}$$

The ray diagram is shown in figure.

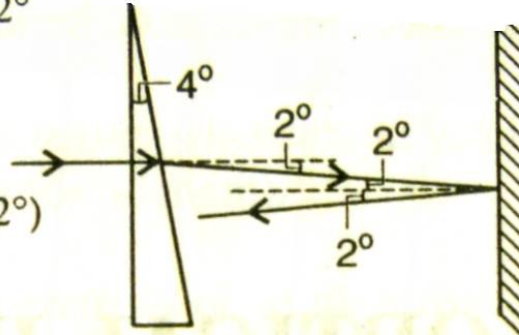

Optics - 5 ) How do we find focal length of a lens ?

### Focal length of convex lens by displacement method:

- (i) When the distance between object and screen  $d$ , is greater than  $4f$ , then there are two positions of the lens for which the image of the object on the screen is distinct and clear. In these two positions of lens, the distances of object and image from the lens are interchanged.

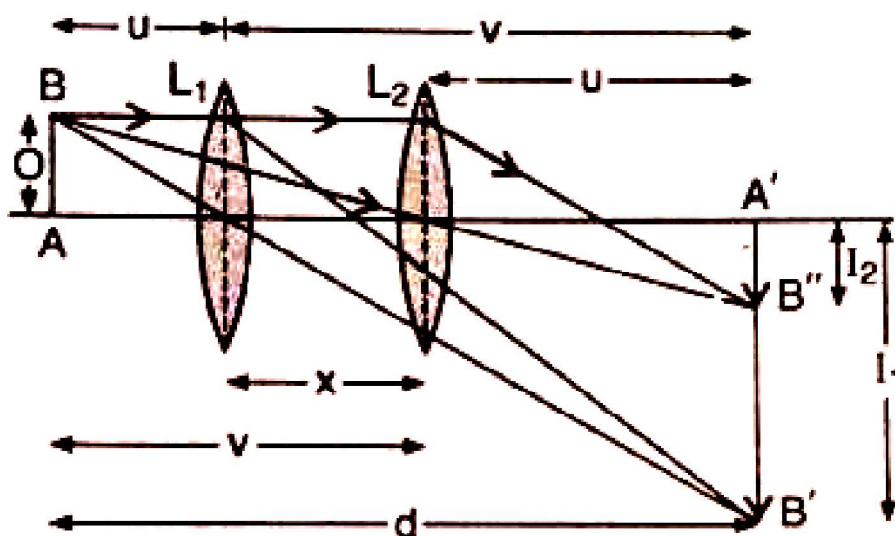

(ii) Here,  $I_1$  and  $I_2$  are the lengths of images in first and second position of lens  $L$ .  $O$  is the length of the object. In first position of lens,

$$m_1 = \frac{v}{u} = \frac{I_1}{O}$$

In second position, the magnification of the lens is

given by:  $m_2 = \frac{u}{v} = \frac{I_2}{O}$

$$\therefore m_1 m_2 = \frac{I_1 I_2}{O^2} = 1$$

$$\therefore O = \sqrt{I_1 I_2}$$

(iii) Further,  $\frac{m_1}{m_2} = \frac{v^2}{u^2}$

From figure,  $u + x + u = d$  or  $u = \frac{d-x}{2}$

According to sign convention,  $u = -(d-x)/2$

Similarly,  $v = d - u = (d+x)/2$

Using lens formula,  $\frac{1}{v} - \frac{1}{u} = \frac{1}{f}$ , we get;

$$f = \left( \frac{d^2 - x^2}{4d} \right)$$

In the displacement method, a convex lens is placed in between an object and a screen. If the magnifications in the two positions are  $m_1$  and  $m_2$  and the displacement of the lens between the two positions is  $x$ , then the focal length of the lens is:

(a)  $\frac{x}{(m_1 + m_2)}$

(b)  $\frac{x}{(m_1 - m_2)}$

(c)  $\frac{x}{(m_1 + m_2)^2}$

(d)  $\frac{x}{(m_1 - m_2)^2}$

$$m_1 = \frac{v}{u}, m_2 = \frac{u}{v}$$

$$m_1 - m_2 = \frac{v}{u} - \frac{u}{v}$$

$$m_1 - m_2 = \frac{v^2 - u^2}{uv} = \frac{(v - u)(v + u)}{uv}$$

$$\text{Now } v - u = x, \frac{1}{f} = \frac{1}{v} + \frac{1}{u} \quad \text{or} \quad \frac{1}{f} = \frac{u + v}{uv}$$

$$\therefore m_1 - m_2 = \frac{x}{f} \quad \text{or} \quad f = \frac{x}{m_1 - m_2}$$

Optics - 6 ) Circle of least confusion

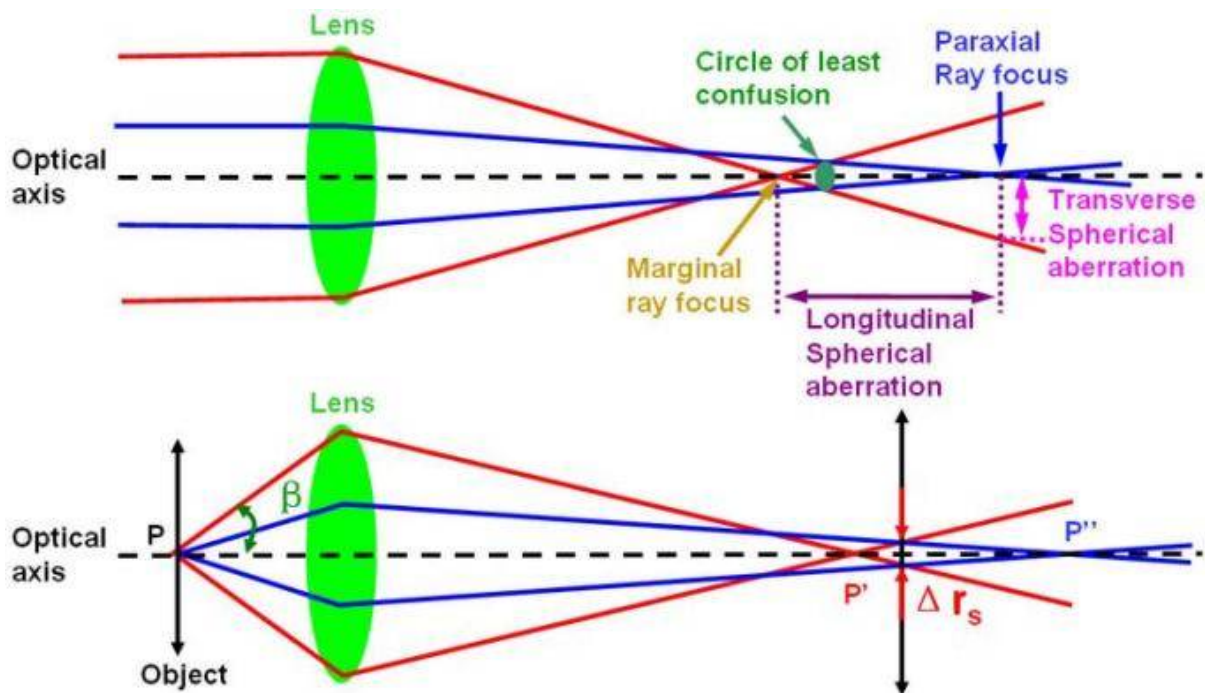

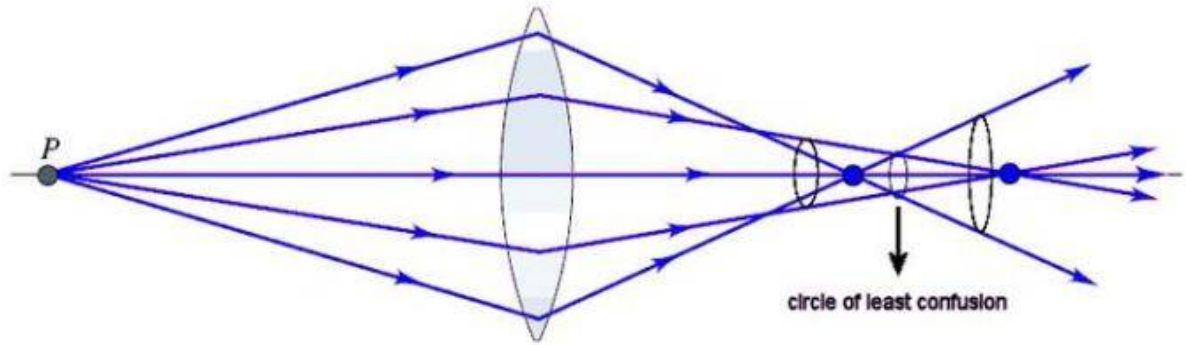

Optics - 7 )



Deviation diagrams

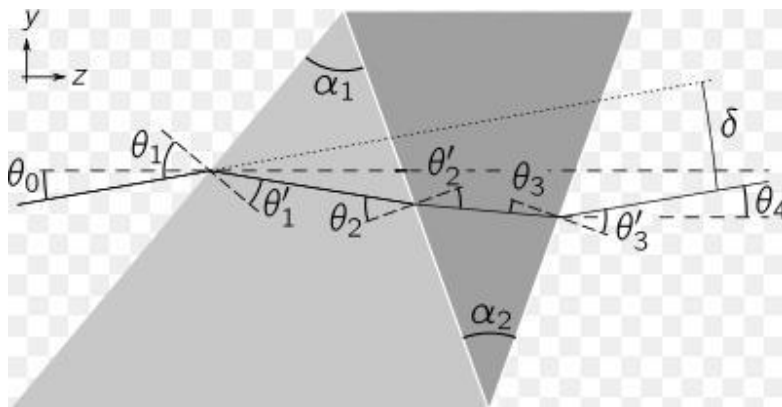

Gravitation by Prof. Subhashish Chattopadhyay SKMClasses Bangalore Useful for IIT-JEE, CBSE, I.Sc. PU-II, Boards, CET, CEE, PET, IGCSE IB AP-Physics and other exams

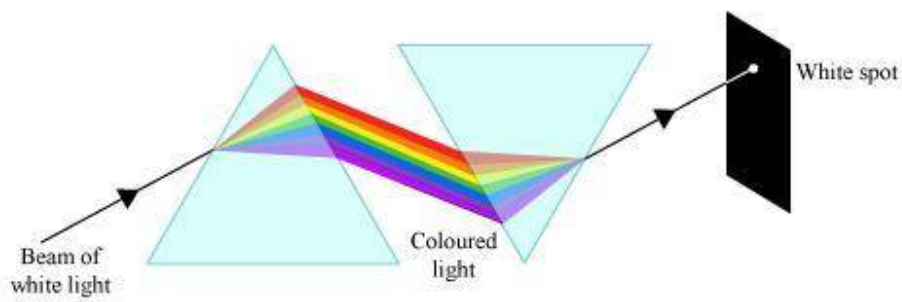
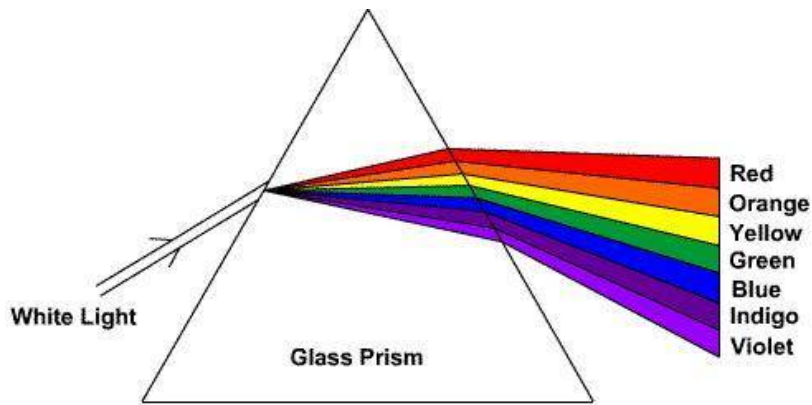

Gravitation by Prof. Subhashish Chattopadhyay SKMClasses Bangalore Useful for IIT-JEE, CBSE, I.Sc. PU-II, Boards, CET, CEE, PET, IGCSE IB AP-Physics and other exams

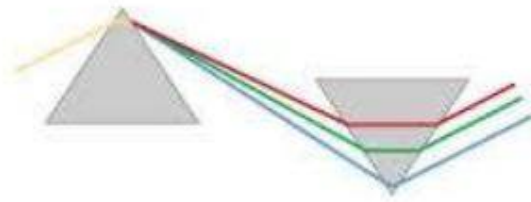

Prisms with equal vertex angle (= light deviation power) and same glass type (= equal dispersion) can exactly cancel out color that is between them.

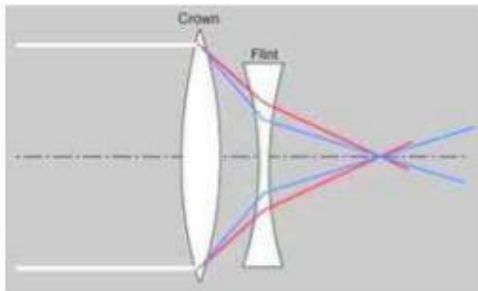

The color of a positive lens can be cancelled by an equal power negative lens of the same glass, but then the focal length of the lens pair would be zero, if they were in contact. Instead we want the negative lens to be a more dispersive glass than the positive lens, so that a weaker power negative lens can still cancel out the color and give a total power of the lens pair that is not zero. When the red and blue light rays come to the same focus primary color has been corrected.

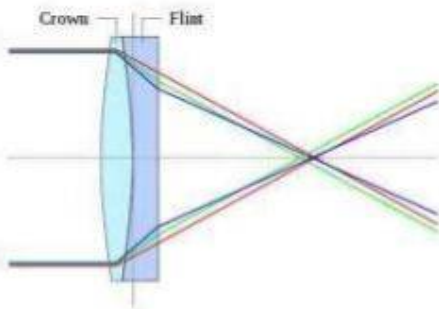

In a typical contact doublet the negative lens glass is about 1.5X to 2X more dispersive than the positive lens glass.

**Chromatic aberration**

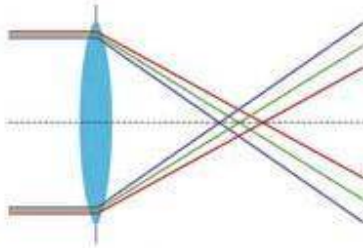

**An achromatic lens**

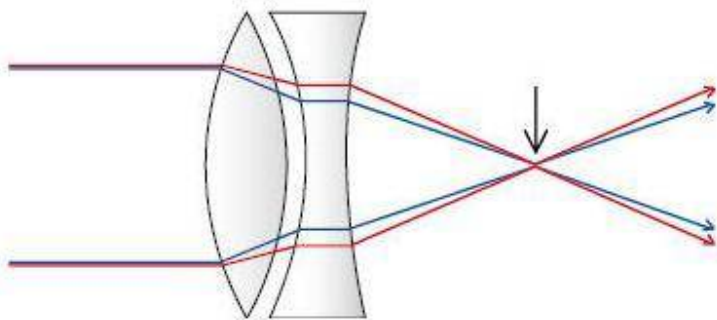
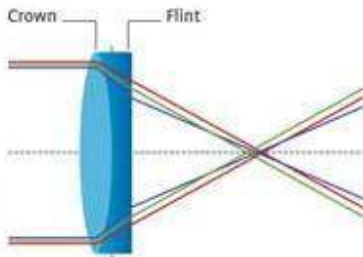

While this combination will also have a circle of least confusion

**Longitudinal and Transverse Spherical Aberration**

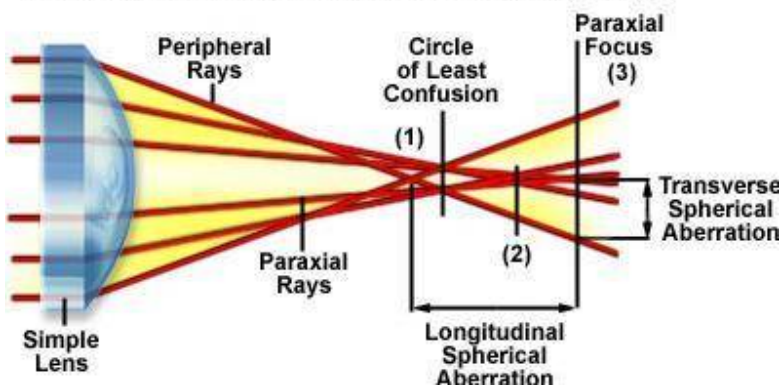

Optics - 8 ) Aspherical lenses can be used to reduce axial spread ( of paraxial rays ), apart from stoppers or rather with combinations of stoppers.

## Aspherical Lens

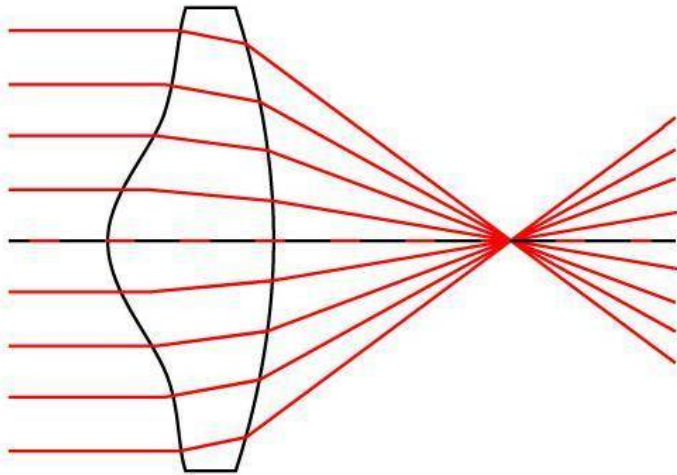

Remember more curved surface should face the light first. In plano-convex lens the convex part should face the light for better utilization of refraction properties. Also this minimizes the errors.

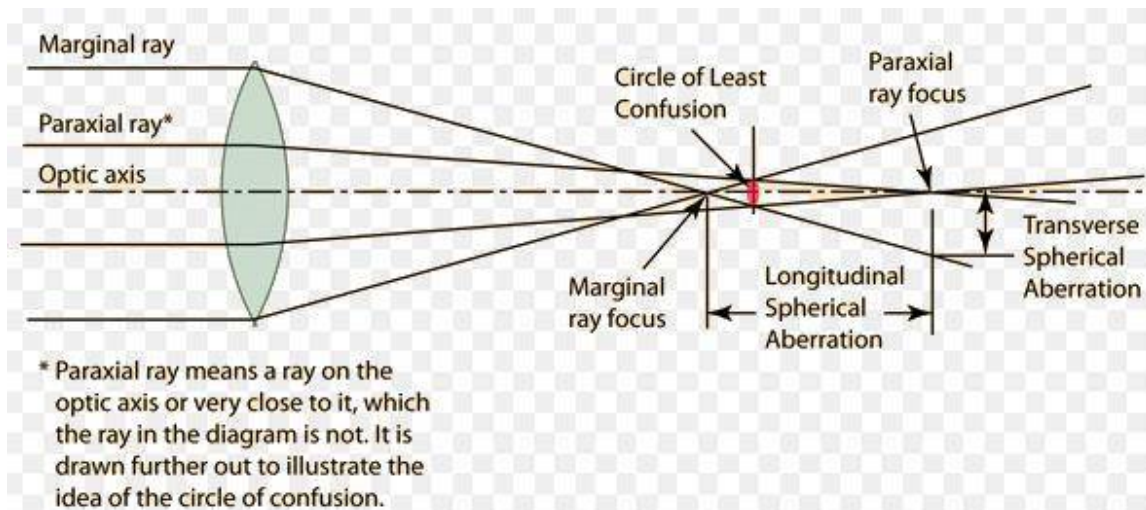



Optics - 9 ) The conical image of a point

Looking at only red and blue light:

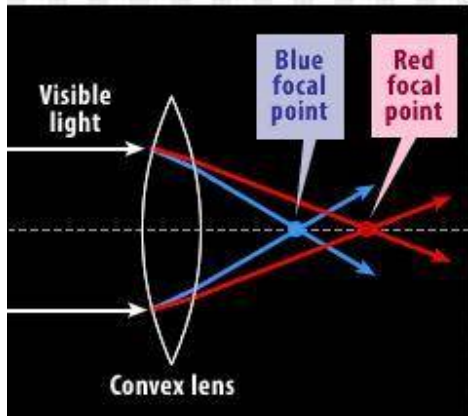

**Result:** A fringe of color may appear around bright objects seen through the lens:



A star, as seen through a telescope without chromatic aberration



A star, as seen through a telescope with chromatic aberration (exaggerated)

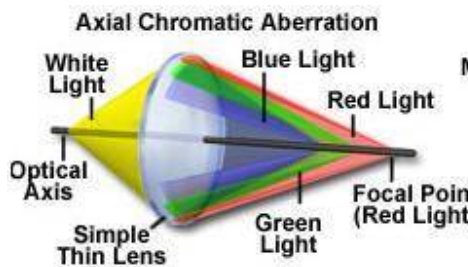

Axial Chromatic Aberration

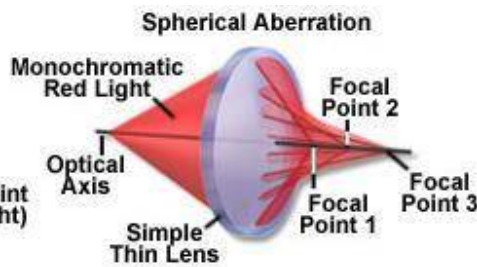

Spherical Aberration

Optics - 10 ) Split lenses

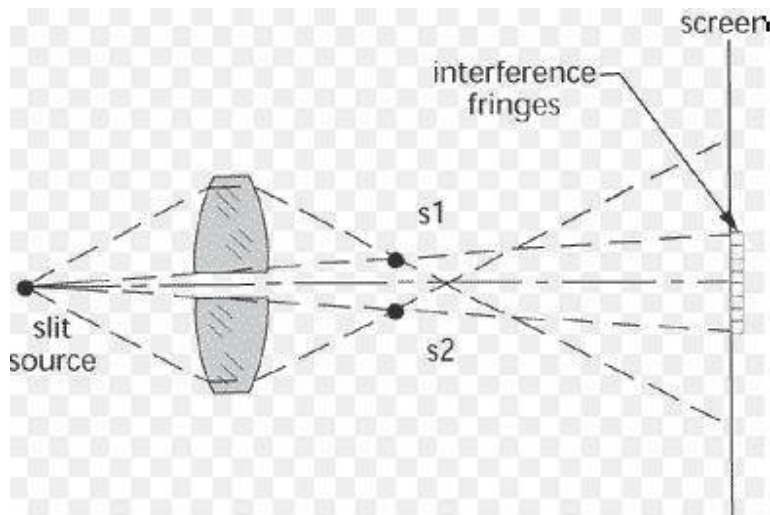

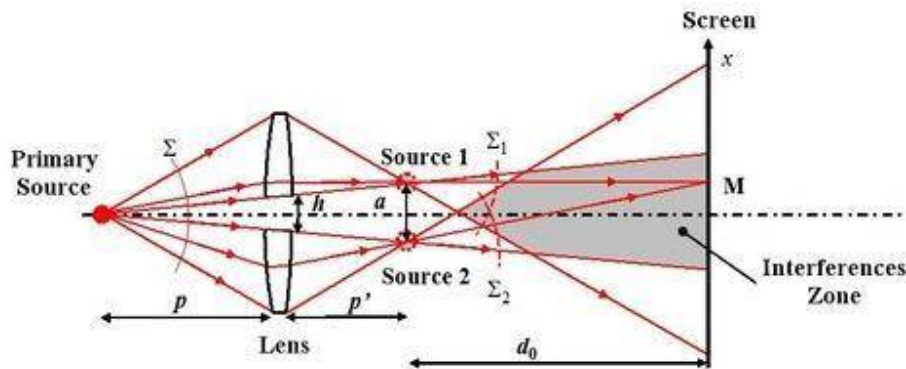

- Was asked in Physics Olympiad before being asked in IIT JEE

A thin plano-convex lens of focal length  $f$  is split into two halves. One of the halves is shifted along the optical axis. The

separation between object and image planes is 1.8 m. The magnification of the image formed by one of the half lens is 2. Find the focal length of the lens and separation between the halves. Draw the ray diagram for image formation. (1996, 5M)

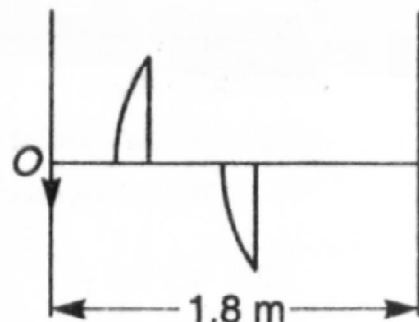

Solution

For both the halves, position of object and image is same. Only difference is of magnification. Magnification for one of the halves is given as  $2 (> 1)$ . This can be for the first one, because for this,  $|v| > |u|$ . Therefore, magnification,  $|m| = |v/u| > 1$

So, for the first half

$$|v/u| = 2 \quad \text{or} \quad |v| = 2|u|$$

Let  $u = -x$  then  $v = +2x$  and  $|u| + |v| = 1.8\text{m}$

$$\text{i.e., } 3x = 1.8 \text{ m} \quad \text{or} \quad x = 0.6 \text{ m}$$

Hence,  $u = -0.6 \text{ m}$  and  $v = +1.2 \text{ m}$ .

$$\text{Using, } \frac{1}{f} = \frac{1}{v} - \frac{1}{u} = \frac{1}{1.2} - \frac{1}{-0.6} = \frac{1}{0.4}$$

$$\therefore f = 0.4 \text{ m}$$

For the second half

$$\frac{1}{f} = \frac{1}{1.2 - d} - \frac{1}{-(0.6 + d)}$$

$$\text{or } \frac{1}{0.4} = \frac{1}{1.2 - d} + \frac{1}{0.6 + d}$$

Solving this, we get  $d = 0.6 \text{ m}$ .

Magnification for the second half will be

$$m_2 = \frac{v}{u} = \frac{0.6}{-(1.2)} = -\frac{1}{2}$$

and magnification for the first half is

$$m_1 = \frac{v}{u} = \frac{1.2}{-(0.6)} = -2$$

The ray diagram is as follows :

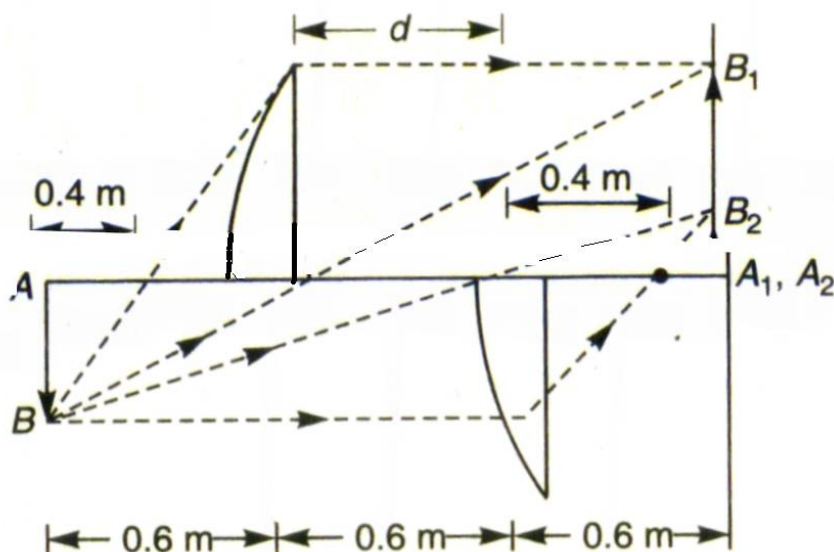

In given figure,  $S$  is a monochromatic point source emitting light of wavelength  $\lambda = 500\text{ nm}$ . A thin lens of circular shape and focal length  $0.10\text{ m}$  is cut into two identical halves  $L_1$  and  $L_2$  by a plane passing through a diameter. The two halves are placed symmetrically about the central axis  $SO$  with a gap of  $0.5\text{ mm}$ . The distance along the axis from  $S$  to  $L_1$  and  $L_2$  is  $0.15\text{ m}$  while that from  $L_1$  and  $L_2$  to  $O$  is  $1.30\text{ m}$ . The screen at  $O$  is normal to  $SO$ . (1993, 5+1M)

Solution

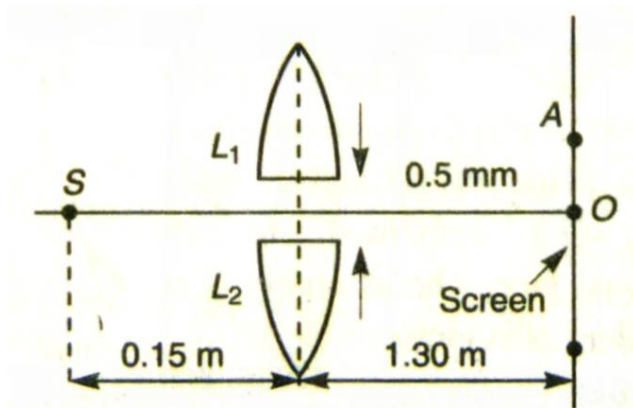

If the third intensity maximum occurs at the point  $A$  on the screen, find the distance  $OA$ .

If the gap between  $L_1$  and  $L_2$  is reduced from its original value of  $0.5\text{ mm}$ , will the distance  $OA$  increase, decrease, or remain the same.

(a) For the lens,  $u = -0.15 \text{ m}$ ;  $f = +0.10 \text{ m}$

Therefore, using  $\frac{1}{v} - \frac{1}{u} = \frac{1}{f}$  we have

$$\frac{1}{v} = \frac{1}{u} + \frac{1}{f}$$

$$= \frac{1}{(-0.15)} + \frac{1}{(0.10)}$$

or  $v = 0.3 \text{ m}$

Linear magnification,  $m = \frac{v}{u} = \frac{0.3}{-0.15} = -2$

Hence, two images  $S_1$  and  $S_2$  of  $S$  will be formed at  $0.3 \text{ m}$  from the lens as shown in figure. Image  $S_1$  due to part 1

will be formed at  $0.5 \text{ mm}$  above its optic axis ( $m = -2$ ). Similarly,  $S_2$  due to part 2 is formed  $0.5 \text{ mm}$  below the optic axis of this part as shown.

Hence,  $d =$  distance between  $S_1$  and  $S_2 = 1.5 \text{ mm}$

$$D = 1.30 - 0.30 = 1.0 \text{ m} = 10^3 \text{ mm}$$

$$\lambda = 500 \text{ nm} = 5 \times 10^{-4} \text{ mm}$$

Therefore, fringe width,

$$\omega = \frac{\lambda D}{d} = \frac{(5 \times 10^{-4})(10^3)}{(1.5)} = \frac{1}{3} \text{ mm}$$

Now, as the point  $A$  is at the third maxima

$$OA = 3\omega = 3(1/3) \text{ mm}$$

or  $OA = 1 \text{ mm}$

(b) If the gap between  $L_1$  and  $L_2$  is reduced,  $d$  will decrease. Hence, the fringe width  $\omega$  will increase or the distance  $OA$  will increase.

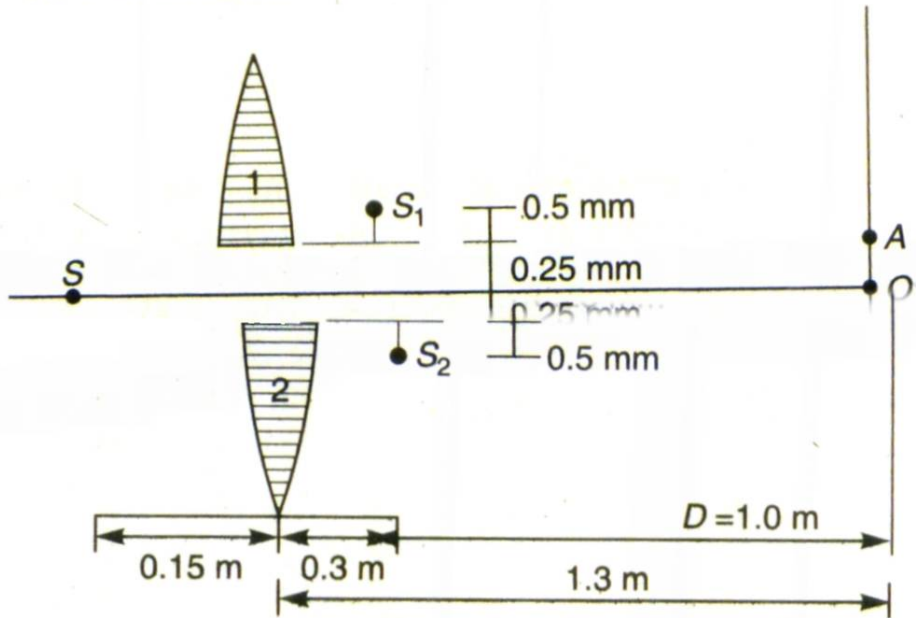

Optics - 11 ) Lloyd's Mirror

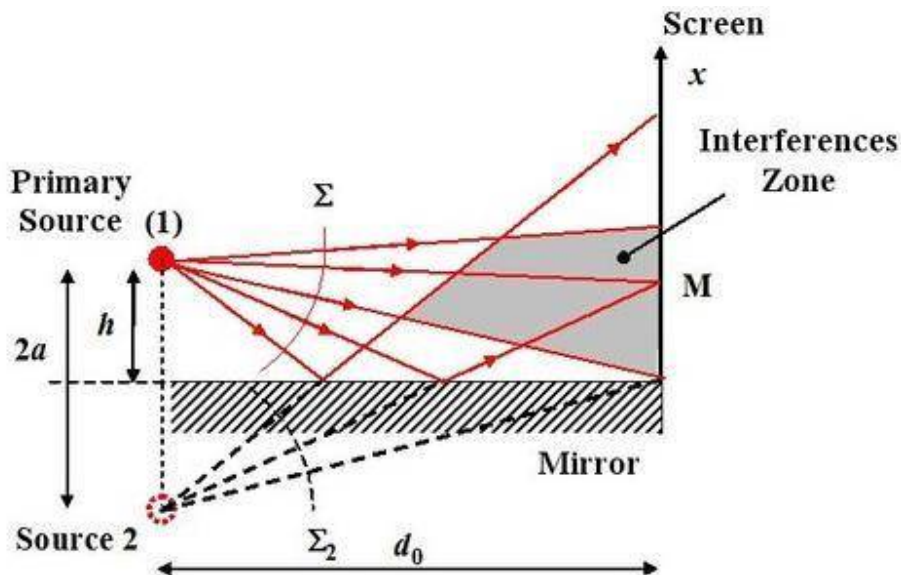

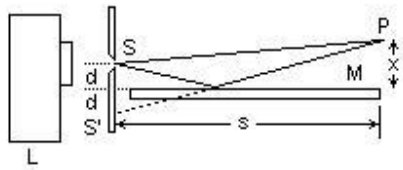

Lloyd's Mirror

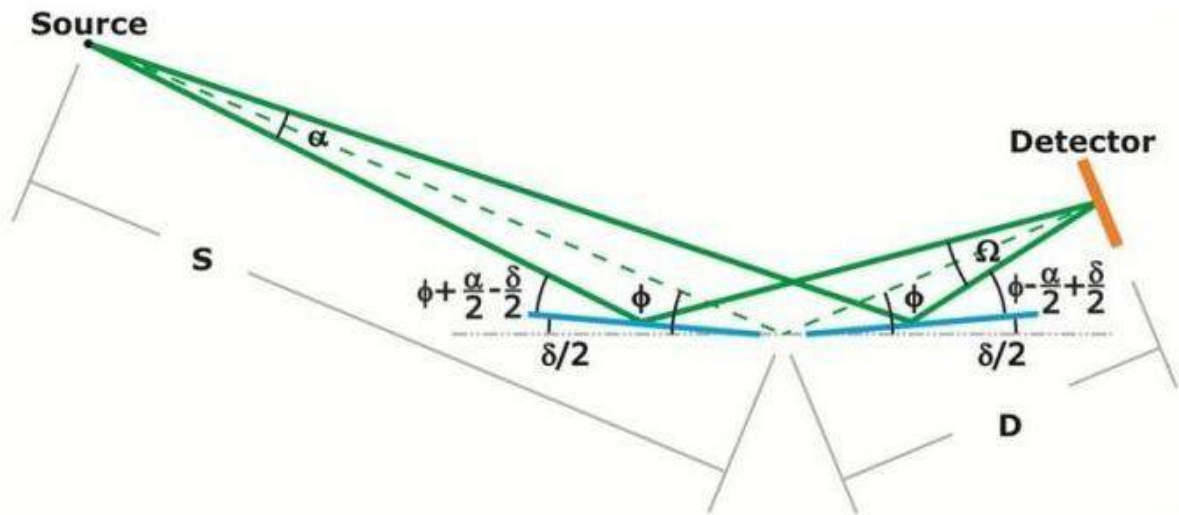

Optics - 12 ) Newton's Rings

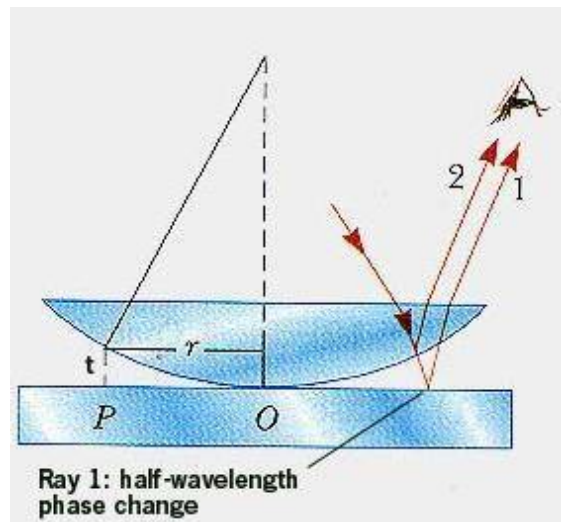
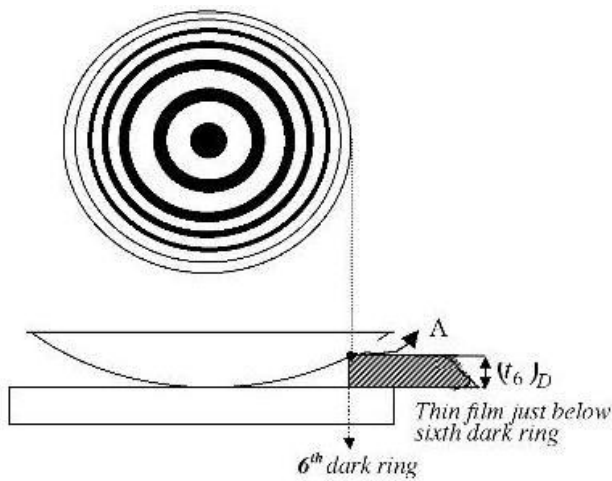

film thickness  $t$ .

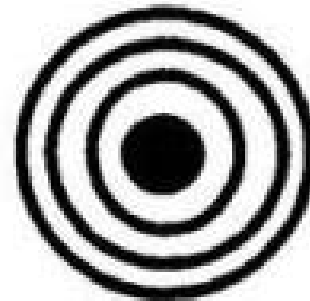
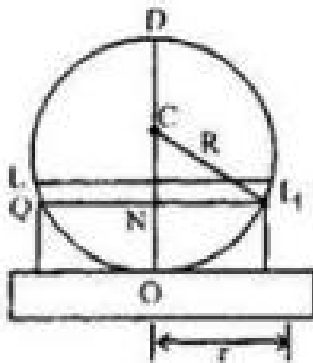

Fig. Newton Rings in Reflected Light

$$2t + \frac{\lambda}{2} = n\lambda$$

$$2t = \frac{(2n-1)\lambda}{2} \text{ for a bright ring } n = 1, 2, 3, \dots$$

&

$$2t = n\lambda \text{ for dark ring } n = 0, 1, 2, 3, \dots$$

From the property of the circle,

$$NP \times NQ = NO \times ND$$

Substituting values,

$$r \times r = t \times (2R - t) = 2Rt - t^2 \approx 2Rt \text{ approximately.}$$

$\therefore$

$$t = \frac{r^2}{2R}$$

Thus, for bright ring,

$$2 \cdot \frac{r^2}{2R} = \frac{(2n-1)\lambda}{2}$$

$$r = \frac{D}{2} \text{ where } D \text{ is diameter}$$

$$\frac{D^2}{4} = \frac{(2n-1)\lambda R}{2}$$

$$D_n = \sqrt{2(2n-1)\lambda R}$$

$$D_n \propto \sqrt{(2n-1)}$$

i.e., diameter of  $n^{\text{th}}$  bright ring is proportional to square root of odd natural number.



Optics - 13 ) Plano-Convex lens problems

The apparent thickness of a thick plano-convex lens is measured once with the plane face upward and then with the convex face upwards. The value will be :

- (a) More in the first case.
- (b) Same in the two cases
- (c) More in the II case
- (d) Can be any of the above depending on the value of its actual thickness

The apparent thickness in case (a)

$$OA' = \frac{\text{real } (OA)}{\mu} = \frac{t}{\mu}$$

In case (b) when the convex surface is placed down then refraction takes place through curved surface.

Object is in denser medium, then  $\mu_2 = 1, \mu_1 = \mu$

$$\therefore \text{ by } \frac{\mu_2}{v} - \frac{\mu_1}{u} = \frac{\mu_2 - \mu_1}{R}$$

$$\frac{1}{v} + \frac{\mu}{t} = \frac{1 - \mu}{-R}$$

$$\frac{1}{v} = \frac{(\mu - 1)}{R} - \frac{\mu}{t}$$

$$v = \frac{Rt}{(\mu - 1)t - \mu R}$$

Clearly in the second case the apparent thickness is more.

Optics - 14 ) Lens problems with graphs

The graph shows how the magnification  $m$  produced by a thin convex lens varies with image distance  $v$ . What was the focal length of the lens used ?

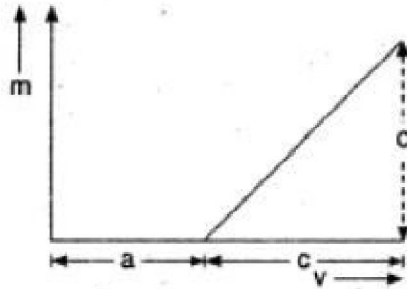

- (a)  $b/c$     (b)  $b/ca$     (c)  $bc/a$     (d)  $c/b$

For point B,  $m = b$  or  $\frac{v}{u} = b$

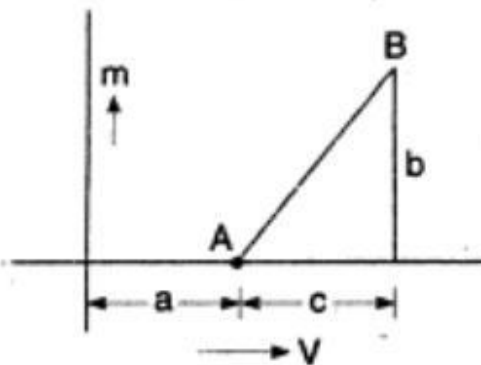

$$\frac{(a+c)}{u} = b \text{ or } u = \left(\frac{a+c}{b}\right)$$

$$\frac{1}{f} = \frac{1}{(a+c)} + \frac{b}{(a+c)} = \frac{(1+b)}{(a+c)} \text{ or } f = \left(\frac{a+c}{1+b}\right) \dots(1)$$

Again for point A,  $m = 0$

$$v = a, m = 0 = \frac{v}{u} = \frac{a}{u}$$

$$u = \infty \therefore v = a = f$$

Putting in (1)

$$f = \frac{f+c}{1+b}, f+fb = f+c \text{ or } f = \frac{c}{b}$$

IIT JEE 2011

A light ray traveling in glass medium is incident on glass-air interface at an angle of incidence  $\theta$ . The reflected ( R ) and transmitted ( T ) intensities, both as function of  $\theta$ , are plotted. The correct sketch is

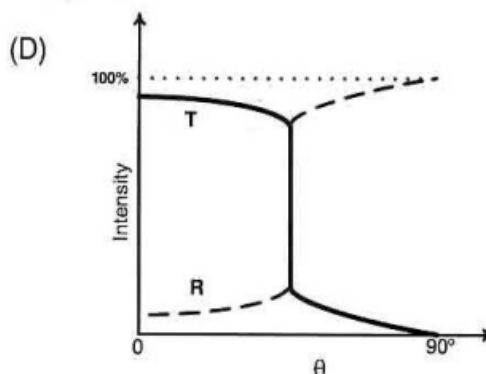
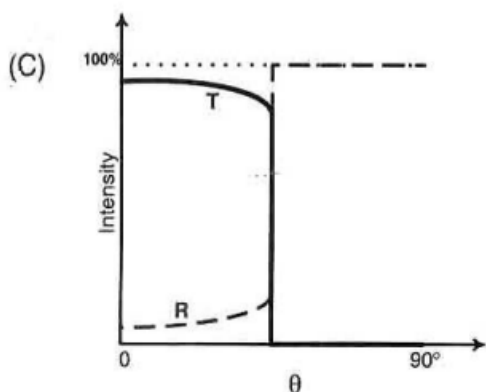
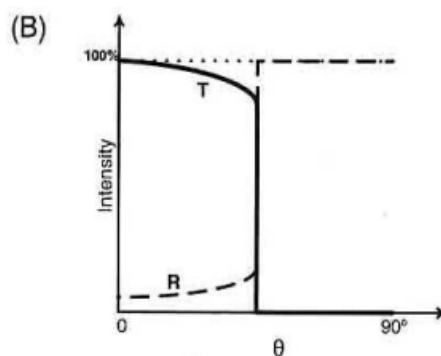
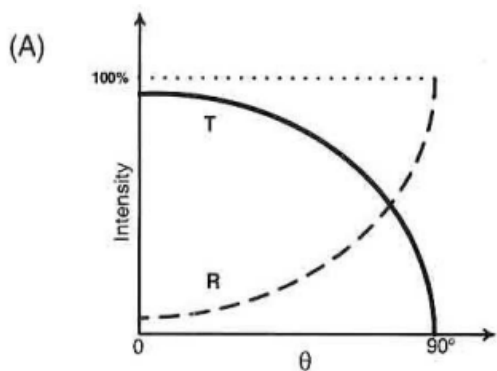

Answer [ c ]

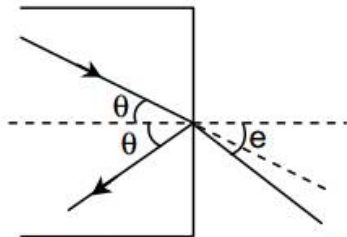

When  $\theta > \theta_c$ , no ray will transmit  
 $\Rightarrow T = 0, T + R = 100\%$  and  $R > 0$

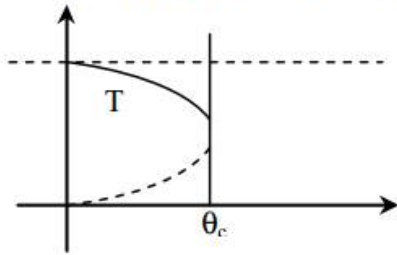

A ray of light travels from a medium of refractive index  $\mu$  to air. Its angle of incidence in the medium is  $\theta$ , measured from the normal to the boundary and its angle of deviation is  $\delta$ .  $\delta$  is plotted against  $\theta$  which of the following best represents the resulting curve?

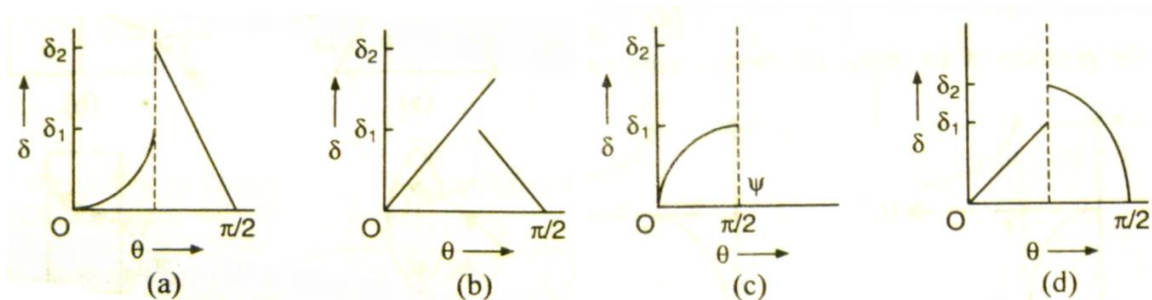

Answer ( a )

In the above problem which of the following relations are correct

(a)  $\psi = \sin^{-1} \left( \frac{1}{\mu} \right)$

(b)  $\psi = \frac{\pi}{2} - \sin^{-1} \left( \frac{1}{\mu} \right)$

(c)  $\frac{\delta_2}{\delta_1} = \mu$

(d)  $\frac{\delta_2}{\delta_1} = 2$

Answer ( a ) and ( d )

For which of the following cases  $(\sin i/\sin r)$  is equal to  $(\mu/\mu_0)$ ?

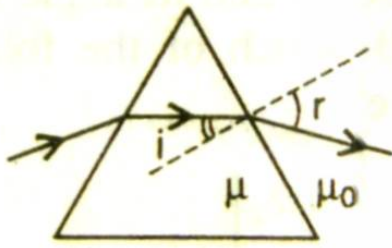

(a)

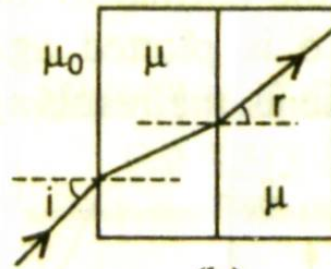

(b)



(c)

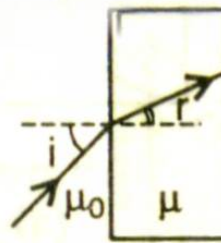

(d)

Answer - b, c, d

As the position of an object ( u ) from a concave mirror is varied, the position of the image ( v ) also varies. By letting u change from 0 to ∞ the graph between v and u will be ?

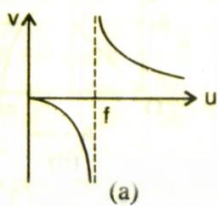

(a)

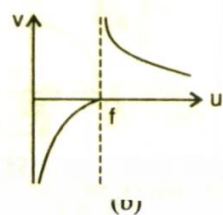

(b)

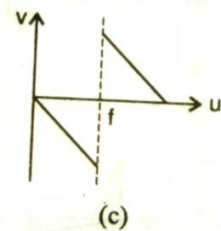

(c)

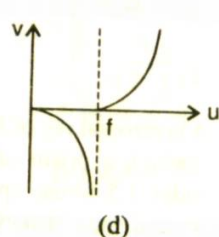

(d)

Answer - ( a )

A reflecting surface is represented by the equation  $x^2 + y^2 = a^2$ . A ray travelling in negative  $x$ -direction is directed towards positive  $y$ -direction after reflection from the surface at some point  $P$ . Then the co-ordinates of point  $P$  are:

- (a)  $(0.8a, 0.6a)$
- (b)  $(0.6a, 0.8a)$
- (c)  $(a, 0)$
- (d) none of the above

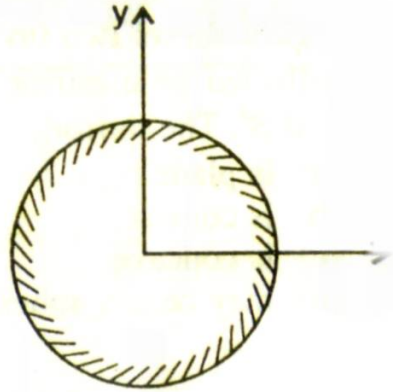

The ray diagram is shown in the figure.

$$x = \frac{a}{\sqrt{2}} \quad \text{and} \quad y = \frac{a}{\sqrt{2}}$$

$$\therefore P = \left( \frac{a}{\sqrt{2}}, \frac{a}{\sqrt{2}} \right)$$

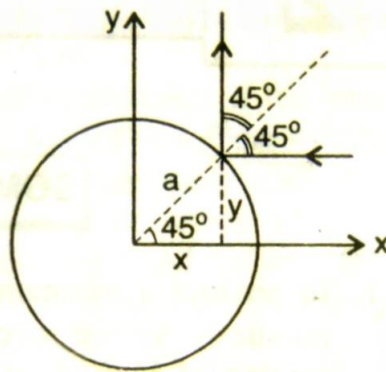

So Answer - ( d )

Optics - 15 ) Lens immersed in a liquid

The focal length of lens of refractive index 1.5 in air is 30 cm. When it is immersed in a liquid of refractive index  $\frac{4}{3}$ , then its focal length in liquid will be

- (a) 30 cm
  - (b) 60 cm
  - (c) 120 cm
  - (d) 240 cm
- (BHU 2002)

We know that focal length in liquid

$$(f_m) = \left[ \frac{\mu_g - 1}{(\mu_g / \mu_m) - 1} \right] \times f_a = \left[ \frac{1.5 - 1}{(1.5 / 1.33) - 1} \right] \times 30$$

$$= \left[ \frac{1.5 - 1}{1.125 - 1} \right] \times 30 = 120 \text{ cm.}$$

A bi-convex lens ( $\mu = 1.5$ ) of focal length 0.2 m acts as a divergent lens of power one dioptre when immersed in a liquid. The refractive index of the liquid is :

- (a) 1.33      (b) 1.67      (c) 1.25      (d) 1.2

$$f_a = 20 \text{ cm, } f_w = -100 \text{ cm.}$$

$$\therefore \frac{f_w}{f_a} = \frac{(a\mu_g - 1)}{\left( \frac{a\mu_g}{a\mu_w} - 1 \right)} \quad \text{or} \quad -\frac{100}{20} = \frac{(1.5 - 1)}{\left( \frac{1.5}{a\mu_w} - 1 \right)}$$

$$\text{or } \frac{1.5}{a\mu_w} - 1 = -\frac{0.5}{5} = -\frac{1}{10}$$

$$\therefore \frac{1.5}{a\mu_w} = 1 - \frac{1}{10} = \frac{9}{10}$$

$$a\mu_w = \frac{15}{9} = 1.67$$

Karnataka CET 1996 problem - Lens put in Slab with liquid

Shown in the figure is a convergent lens placed inside a cell filled with a liquid. The lens has a focal length +20 cm. when in air and its material has a refractive index 1.50. If the liquid has a refractive index 1.60, the focal length of the system is: (II-U-1-3)

- 1) -24 cm                      2) -100 cm  
3) +80 cm                     4) -80 cm

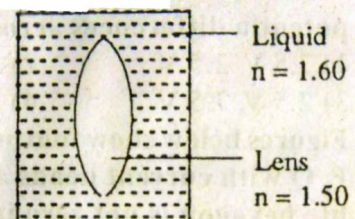

$$\begin{aligned} \text{In air } \frac{1}{f} &= (n_g - 1) \left( \frac{1}{R_1} + \frac{1}{R_2} \right) \\ \frac{1}{20} &= 0.5 \left( \frac{1}{R_1} + \frac{1}{R_2} \right) \rightarrow \left( \frac{1}{R_1} + \frac{1}{R_2} \right) = \frac{1}{20 \times 0.5} = \frac{1}{10} \\ \text{In the liquid} \\ \frac{1}{f^l} &= \left( \frac{n_g}{n_e} - 1 \right) \left( \frac{1}{R_1} + \frac{1}{R_2} \right) = \left( \frac{1.5}{1.6} - 1 \right) \times \frac{1}{10} \\ &= -\frac{1}{16} \times \frac{1}{10} = -\frac{1}{160} \quad \text{or} \quad f = -160 \text{ cm} \end{aligned}$$

If the formula was printed as +ve, then the absolute values of Radius will be taken.

Given  ${}^a\mu_g = 3/2$  and  ${}^a\mu_w = 4/3$ . There is an equiconvex lens with radius of each surface equal to 20 cm. There is air in the object space and water in the image space. The focal length of lens is:

- (a) 80 cm      (b) 40 cm      (c) 20 cm      (d) 10 cm

Solution :

$$\begin{aligned} \frac{{}^a\mu_w}{f} &= \frac{({}^a\mu_g - 1)}{R_1} - \frac{({}^a\mu_g - {}^a\mu_w)}{R_2} \\ &= \frac{\left( \frac{3}{2} - 1 \right)}{20} - \frac{\left( \frac{3}{2} - \frac{4}{3} \right)}{-20} = \frac{1}{40} + \frac{1}{120} = \frac{1}{30} \\ f &= \frac{4}{3} \times 30 = 40 \text{ cm} \end{aligned}$$



There can be problems with lens and different transparent materials on either side or both sides

A hollow double concave lens is made of very thin transparent material. It can be filled with air or either of two liquids  $L_1$  or  $L_2$  having refractive indices  $n_1$  and  $n_2$  respectively ( $n_2 > n_1 > 1$ ). The lens will diverge a parallel beam of light if it is filled with: **(IIT 2000)**

- (a) air and placed in air      (b) air and immersed in  $L_1$   
(c)  $L_1$  and immersed in  $L_2$       (d)  $L_2$  and immersed in  $L_1$

Solution : (d)

The lens maker's formula is:

$$\frac{1}{f} = \left( \frac{n_L}{n_m} - 1 \right) \left( \frac{1}{R_1} - \frac{1}{R_2} \right)$$

Where  $n_L$  = refractive index of lens material

$n_m$  = refractive index of medium

In case of double concave lens  $R_1$  is -ve and  $R_2$  is +ve. Therefore

$\left( \frac{1}{R_1} - \frac{1}{R_2} \right)$  will be -ve.

For the lens to be diverging in nature, focal length  $f$  should be

negative or  $\left( \frac{n_L}{n_m} - 1 \right)$  should be positive or  $n_L > n_m$ ; but since

$n_2 > n_1$  (given), therefore the lens should be filled with  $L_2$  and immersed in  $L_1$ .

Optics - 16 ) Trick questions with distance of object, Image, focal length of lenses

The focal length of a convex lens is  $f$ . An object is placed at a distance  $x$  from its first focal point. The ratio of the size of the real image to that of the object is :

- (a)  $f/x^2$     (b)  $x^2/f$     (c)  $f/x$     (d)  $x/f$

$$u = f + x, \frac{1}{f} = \frac{1}{v} - \frac{1}{-u} = \frac{1}{v} + \frac{1}{u}$$

$$\frac{1}{f} = \frac{1}{v} + \frac{1}{f+x} \quad \text{or} \quad \frac{1}{v} = \frac{1}{f} - \frac{1}{f+x}$$

$$\frac{1}{v} = \frac{f+x-f}{f(f+x)} = \frac{x}{f(f+x)} \quad \text{or} \quad v = \frac{f(f+x)}{x}$$

$$\frac{v}{u} = \frac{f(f+x)}{x(f+x)} = \frac{f}{x}$$

An object is placed at a point distant  $x$  from the focus of a convex lens and its image is formed at  $I$  as shown in the figure. The distances  $x, x'$  satisfy the relation :

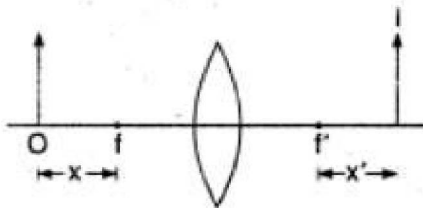

- (a)  $\frac{x \times x'}{2} = f$                       (b)  $f^2 = xx'$   
 (c)  $x + x' = 2f$                       (d)  $x - x' = 2f$

the magnification is :

- (a)  $\frac{f}{x+x'}$                       (b)  $\frac{x'}{x}$   
 (c)  $\frac{f}{x}$                       (d) None of these

$$xx' = f^2, \text{ Newton's formula.}$$

$$u = f + x, v = f + x'$$

$$m = \frac{v}{u} = \frac{f + x'}{f + x}$$

$$x' = \frac{f^2}{x} \therefore m = \frac{f + f^2/x}{f + x}$$

$$m = \frac{f(x + f)}{x(x + f)} = \frac{f}{x}$$

A convex lens of focal length  $f$  is placed somewhere in between an object and a screen. The distance between the object and the screen is  $x$ . If the numerical value of the magnification produced by the lens is  $m$ , the focal length of the lens is:

(a)  $\frac{mx}{(m+1)^2}$     (b)  $\frac{mx}{(m-1)^2}$     (c)  $\frac{(m+1)^2}{m}x$     (d)  $\frac{(m-1)^2}{m}x$

Here,

$$x = u + v$$

$$m = \frac{f}{f+u} = \frac{f-v}{f}$$

For real image,  $m$  is -ve.

$$\therefore -m = f/(f+u) \quad \text{or} \quad u = \frac{-(m+1)}{m}f$$

and  $-m = \frac{f-v}{f} \quad \text{or} \quad v = (m+1)f$

$$\therefore x = (m+1)f + \frac{(m+1)}{m}f \quad \text{or} \quad f = \frac{mx}{(m+1)^2}$$

The distance between object and the screen is  $D$ . Real images of an object are formed on the screen for two positions of a lens separated by a distance  $d$ . The ratio between the sizes of two images will be:

- (a)  $D/d$  (b)  $D^2/d^2$   
 (c)  $(D-d)^2/(D+d)^2$  (d)  $\sqrt{(D/d)}$

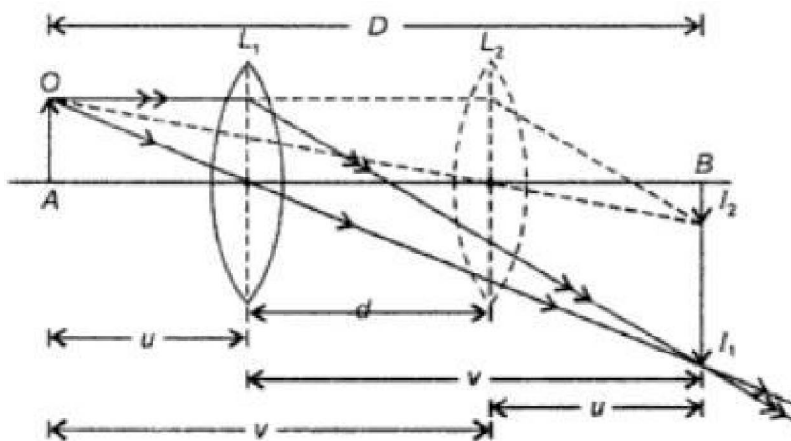

Let  $O$  be the size of object held perpendicular to the principal axis of the lens. A real, inverted and magnified image of size  $I_1$  is formed when the lens is at position  $L_1$ . When the lens is shifted to position  $L_2$  after moving to a distance  $d$ , a diminished image of size  $I_2$  is formed.

The magnification produced by lens, when image size is  $I_1$ .

$$m_1 = \frac{I_1}{O} = \frac{v}{u} \quad \dots(i)$$

The magnification produced by lens, when image size is  $I_2$ .

$$m_2 = \frac{l_2}{O} = \frac{u}{v} \quad \dots(ii)$$

(By the principle of conjugate focii we can assume position of image as object position and vice-versa)

From equation (i) and (ii), we get

$$m_1 m_2 = \frac{l_1}{O} \times \frac{l_2}{O} = \frac{v}{u} \times \frac{u}{v}$$

or  $m_1 m_2 = 1$

and  $O = \sqrt{l_1 l_2}$

Again, from equation (i) and (ii)

$$\frac{m_1}{m_2} = \frac{l_1}{l_2} = \frac{v^2}{u^2}$$

From the figure,  $D = u + v$

and  $d = v - u$

Then  $v = \frac{D + d}{2}$  and  $u = \frac{D - d}{2}$

Hence,  $\frac{m_1}{m_2} = \frac{l_1}{l_2} = \left( \frac{D + d}{D - d} \right)^2$

Using lens formula  $\frac{1}{f} = \frac{1}{v} - \frac{1}{u}$  and putting the value of

$$u = -\left( \frac{D - d}{2} \right) \text{ and } v = +\left( \frac{D + d}{2} \right), \text{ we get}$$

$$f = \frac{D^2 - d^2}{4D}$$

The focal length of lens can also be calculated by relation

$$f = \frac{d}{m_1 - m_2}$$

Thus

- (i) The minimum distance between the object and its real image is  $4f$ .
- (ii) If the distance between object and screen is greater than  $4f$ . There will be two positions separated by  $d$  for the lens which gives sharp image on the screen.
- (iii) As the lens is moved away from the source, the diminished image is formed.

(iv) Power of lens can also be calculated by the relation

$$P = \frac{4D}{D^2 - d^2}$$

A convex lens produces an image of real object

on a screen with magnification  $\frac{1}{2}$  when the

lens is moved 30 cm towards the object, the magnification of the image on the screen is 2.

Find the focal length of the lens.

**Solution :** Since,  $f = \frac{d}{m_1 - m_2}$

Here  $d = 30$  cm,  $m_1 = 2$  and  $m_2 = \frac{1}{2}$

So,  $f = \frac{30}{2 - \frac{1}{2}} = 20$  cm.

A short linear object of length  $L$  lies on the axis of a spherical mirror of focal length  $f$  at a distance  $u$  from the mirror. Its image has an axial length  $L'$  equal to ?

(a)  $L \left[ \frac{f}{(u-f)} \right]^{1/2}$

(b)  $L \left[ \frac{(u+f)}{f} \right]^{1/2}$

(c)  $L \left[ \frac{(u-f)}{f} \right]^2$

(d)  $L \left[ \frac{f}{(u-f)} \right]^2$

Solution :

$$\frac{1}{v} + \frac{1}{u} = \frac{1}{f} \quad \text{or} \quad -\frac{dv}{v^2} - \frac{du}{u^2} = 0$$

i.e.,  $dv = -du[v/u]^2$

But  $v = \frac{uf}{(u-f)}$  or  $\frac{v}{u} = \frac{f}{(u-f)}$

So  $dv = -du \left[ \frac{f}{(u-f)} \right]^2$

Hence,  $|dv| = L \left[ \frac{f}{(u-f)} \right]^2$

A concave mirror of focal length  $f$  produces an image  $n$  times the size of the object. If the image is real, then the distance of the object from the mirror is:

- (a)  $(n - 1)f$                       (b)  $[(n - 1)/n]f$   
(c)  $[(n + 1)f/n]$                 (d)  $(n + 1)f$

As the image is real it will be inverted and so

$$m = -(v/u) = -n, \quad \text{i.e.,} \quad v = nu$$

$$\therefore \quad \frac{1}{v} + \frac{1}{u} = \frac{1}{f} \quad \text{or} \quad \frac{1}{nu} + \frac{1}{u} = \frac{1}{-f}$$

$$\text{or} \quad \frac{(1+n)}{nu} = -\frac{1}{f} \quad \text{or} \quad u = -\frac{(n+1)}{n}f$$

i.e., object is in front of mirror at a distance  $[(n + 1)f/n]$ .

A convex mirror of focal length  $f$  produces an image  $(1/n)$ th of the size of the object. The distance of the object from the mirror is:

- (a)  $nf$                       (b)  $f/n$                       (c)  $(n + 1)f$                 (d)  $(n - 1)f$

Solution :

As the image formed by a convex mirror is always virtual or erect, so

$$m = -(v/u) = + (1/n) \quad \text{or} \quad v = -\frac{u}{n}$$

$$\therefore \quad \frac{1}{v} + \frac{1}{u} = \frac{1}{f} \quad \text{or} \quad -\frac{n}{u} + \frac{1}{u} = \frac{1}{+f}$$

$$\text{or} \quad \frac{-(n-1)}{u} = \frac{1}{f} \quad \text{or} \quad u = -(n-1)f$$

i.e., object is in front of mirror at a distance  $(n - 1)f$ .

Optics - 17 ) Application of Geometry in sphere to understand a plano-convex lens problem

**Diameter of a plano-convex lens is 6 cm and thickness at the centre is 3 mm. If the speed of light in the material of the lens is  $2 \times 10^8$  metres per sec, the focal length of the lens is :**

- (a) 15 cm    (b) 20 cm    (c) 30 cm    (d) 10 cm

Application of Sagitta Theorem

$$\text{R.I. of material of lens } \mu = \frac{c}{v} = \frac{3 \times 10^8}{2 \times 10^8} = 1.5$$

by Sagitta theorem

$$0.3 (2R - 0.3) = 3 \times 3$$

$$0.6R = 9 \quad (\text{neglecting } 0.09)$$

$$R = 15 \text{ cm}$$

$$\frac{1}{f} = (\mu - 1) \left( \frac{1}{R} + \frac{1}{\infty} \right)$$

$$\frac{1}{f} = (1.5 - 1) \left( \frac{1}{15} \right) = \frac{1}{30}$$

$$\text{or } f = 30 \text{ cm.}$$

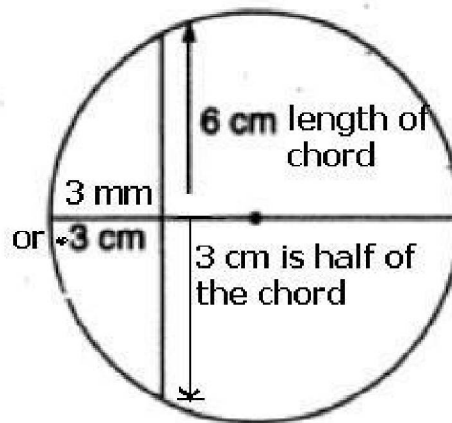

Optics - 18 ) Spherical lens

**A ray of light falls on the surface of a spherical glass paper weight making an angle  $\alpha$  with the normal and is refracted in the medium at an angle  $\beta$ . The angle of deviation of the emergent ray from the direction of the incident ray is :**

- (a)  $(\alpha - \beta)$                       (b)  $2(\alpha - \beta)$   
 (c)  $(\alpha - \beta) / 2$                       (d)  $(\beta - \alpha)$



$\angle CAB = \angle CBA = \beta$  because in  $\Delta ABC$

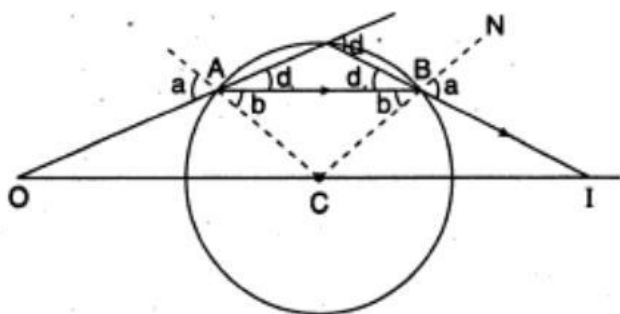

$AC = BC = \text{radius}$

Naturally  $\angle IBN = \alpha$

$\delta_1 = \alpha - \beta, \delta_2 = \alpha - \beta$

$\therefore \delta = \delta_1 + \delta_2 = 2(\alpha - \beta)$

A ray is incident on a sphere, with incidence angle of  $60^\circ$ . Refractive Index of the sphere is  $\sqrt{3}$ . The ray is reflected and refracted on the further surface. The angle between the reflected and refracted surface is ?

Answer  $90^\circ$

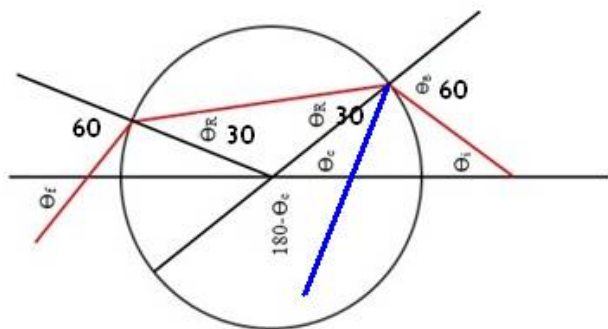

$$\sin 60 / \sin r_1 = \sqrt{3} \Rightarrow \sin r_1 = \frac{1}{2} \Rightarrow r_1 = 30^\circ$$

$$\sin i_2 / \sin r_2 = \sqrt{3} \Rightarrow i_2 = 60^\circ \text{ as } r_1 = r_2 = 30^\circ$$

$$\text{Angle of deviation } 180 - (r_2 + i_2) = 180 - 90 = 90$$

-

Optics - 19 ) Thick lenses

**Refraction through Thick Lens**

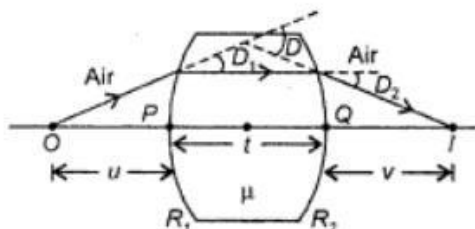

- The focal length of thick lens,

$$\frac{1}{f} = (\mu - 1) \left[ \frac{1}{R_1} - \frac{1}{R_2} + \frac{(\mu - 1)t}{\mu R_1 R_2} \right]$$

- Power of thick lens,

$$P = P_1 + P_2 - \frac{P_1 P_2 t}{\mu}$$

Where,  $P_1$  = Power of first refracting surface

$$P_1 = \frac{\mu - 1}{R_1}$$

and  $P_2$  = Power of second refracting surface

$$P_2 = \frac{1 - \mu}{R_2}$$

A convergent thick lens has radii of curvature 10.0 cm and  $-6.0$  cm,  $\mu = 1.60$  and thickness  $t = 5.0$  cm. Deduce its focal length.

**Solution :** Focal length of a lens of thickness  $t$  is given by

$$\frac{1}{f} = (\mu - 1) \left[ \frac{1}{R_1} - \frac{1}{R_2} + \frac{(\mu - 1)t}{\mu R_1 R_2} \right]$$

Here,  $\mu = 1.60$ ,  $R_1 = +10.0$  cm,  $R_2 = -6.0$  cm and  $t = 5.0$  cm.

$$\therefore \frac{1}{f} = (1.60 - 1) \left[ \frac{1}{10.0} + \frac{1}{6.0} + \frac{(1.60 - 1) \times 5.0}{1.60 \times 10.0 \times (-6.0)} \right]$$

$$\text{or} \quad \frac{1}{f} = 0.60 \left[ \frac{1}{10} + \frac{1}{6} - \frac{1}{32} \right]$$

$$\Rightarrow \quad f = +7.14 \text{ cm.}$$

Optics - 20 ) Cauchy's formula for Refractive Index

$$n_{25^\circ\text{C}} = A + \frac{B}{\lambda^2} + \frac{C}{\lambda^4}$$

Cauchy's formula for  $\mu$

$$n(\lambda) = B + \frac{C}{\lambda^2},$$

Material	B	C ( $\mu\text{m}^2$ )
Fused silica	1.4580	0.00354
Borosilicate glass BK7	1.5046	0.00420
Hard crown glass K5	1.5220	0.00459
Barium crown glass BaK4	1.5690	0.00531
Barium flint glass BaF10	1.6700	0.00743
Dense flint glass SF10	1.7280	0.01342

-

Optics - 21 ) Reflection images in inclined mirrors

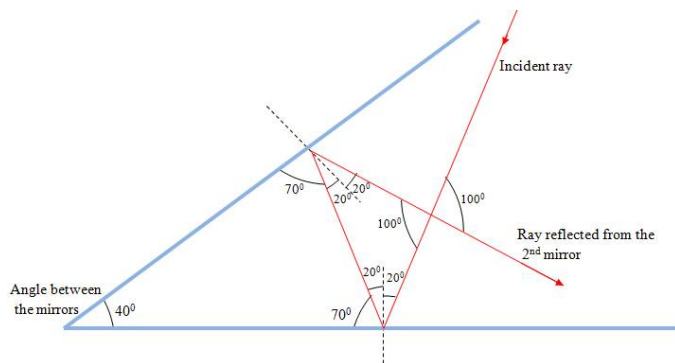
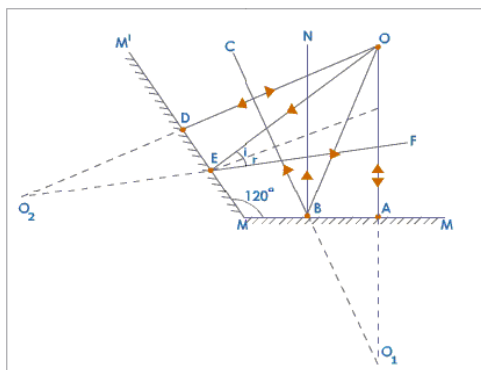

Number of images is given as greatest integer of  $[(360/\theta) - 1]$

-

Optics - 22 ) Optics problems with vectors, 3D imagination

The x - y plane is boundary between two transparent media. Medium-1 with  $z \geq 0$  has a refractive index  $\sqrt{2}$  and medium 2 with  $z \leq 0$  has refractive index  $\sqrt{3}$ . A ray of light in medium-1 given by vector  $\vec{A} = 6\sqrt{3} \hat{i} + 8\sqrt{3} \hat{j} - 10\hat{k}$  is incident on the plane of separation, find the unit vector in the direction of the refracted ray in medium-2.

Solution: Let refracted ray be  $\vec{r} = a\hat{i} + b\hat{j} - c\hat{k}$

$$\text{Normal to plane of incident and normal} = \begin{vmatrix} \hat{i} & \hat{j} & \hat{k} \\ 6\sqrt{3} & 8\sqrt{3} & -10 \\ 0 & 0 & 1 \end{vmatrix}$$

$$= 8\sqrt{3} \hat{i} - 6\sqrt{3} \hat{j}$$

it must also be normal to refracted ray

$$\therefore \vec{r} \cdot \vec{n} = 0$$

$$\Rightarrow 8\sqrt{3} a - 6\sqrt{3} b = 0 \Rightarrow 4a = 3b$$

$$\Rightarrow b = \frac{4a}{3}$$

$$\therefore \cos(\pi - i) = \frac{(6\sqrt{3} \hat{i} + 8\sqrt{3} \hat{j} - 10\hat{k}) \cdot \hat{k}}{\left| 6\sqrt{3} \hat{i} + 8\sqrt{3} \hat{j} - 10\hat{k} \right| \left| \hat{k} \right|}$$

$$= \frac{-10}{20} = \cos 120^\circ$$

$$\therefore i = 60^\circ$$

$$\sqrt{3} \sin r = \sqrt{2} \sin i = \sqrt{2} \times \frac{\sqrt{3}}{2} \Rightarrow \sin r = \frac{1}{\sqrt{2}}$$

$$r = 45^\circ$$

Now since angle between refracted ray and Normal =  $45^\circ$

$$\therefore \cos 45^\circ = \frac{(a\hat{i} + b\hat{j} + c\hat{k}) \cdot \hat{k}}{\sqrt{a^2 + b^2 + c^2}} = \frac{1}{\sqrt{2}}$$

$$\Rightarrow \sqrt{2} c = \sqrt{a^2 + b^2 + c^2}$$

$$\Rightarrow c^2 = a^2 + b^2 = a^2 + \frac{16a^2}{a} = \frac{25a^2}{a}$$

$$\Rightarrow c = \frac{\pm 5a}{3}$$

$$\therefore c = \frac{-5a}{3}$$

$$\therefore r = a\hat{i} + \frac{4a}{3}\hat{j} - \frac{5a}{3}\hat{k} = \frac{a}{3}(3\hat{i} + 4\hat{j} - 5\hat{k})$$

$$r = \frac{3\hat{i} + 4\hat{j} - 5\hat{k}}{\sqrt{50}} = \frac{1}{5\sqrt{2}}(3\hat{i} + 4\hat{j} - 5\hat{k})$$

Optics - 23 ) Problems with continuously varying refractive index ( First asked in IPhO and then in IIT JEE )

A ray of light in air is incident at grazing angle ( $i = 90^\circ$ ) on a long rectangular slab of a transparent medium of thickness  $t = 1.0$  m. The point of incidence is the origin  $A(0, 0)$ .

The medium has a variable index of refraction  $n(y)$  given by  $n(y) = \sqrt{ky^{3/2} + 1}$  where  $k = 1.0 \text{ m}^{-3/2}$ .

The refractive index of air is 1. (i) Obtain a relation between the slope of the trajectory of the ray at a point  $B(x, y)$  in the point. (ii) Obtain an equation for trajectory  $y(x)$  of the ray in

Gravitation by Prof. Subhashish Chattopadhyay SKMClasses Bangalore Useful for IIT-JEE, CBSE, I.Sc. PU-II, Boards, CET, CEE, PET, IGCSE IB AP-Physics and other exams

the point. (iii) Determine the co-ordinates  $(x, y_1)$  of the point P where the ray intersects the upper surface of the slab-air boundary. (d) Indicate the path of the ray subsequently.

Solution:

Taking on arbitrary point P(x, y) refractive index at this point  $n = \left(y^{3/2} + 1\right)^{1/2}$

from Snell's law  $n \sin \theta = \text{constant}$  applying this for initial pt. (when ray is entering medium B) and at point.

$$1 \times \sin 90^\circ = \sqrt{\left(y^{3/2} + 1\right)} \sin i$$

$$\Rightarrow \sin i = \frac{1}{\sqrt{y^{3/2} + 1}} \quad \text{it can be seen that } i = \frac{\pi}{2} - \theta$$

$$\therefore \text{Slope} = \tan \theta = \cot i = \frac{dy}{dx}$$

$$(ii) \frac{dy}{dx} = \cot i = \frac{y^{3/4}}{1}$$

$$\Rightarrow \int y^{-3/4} dy = \int dx$$

$$\Rightarrow x = 4y^{1/4} + C$$

it passes through origin  $\therefore C = 0$

$\therefore x = 4y^{1/4}$  is the equation of trajectory

when ray comes out of the mediums

then  $x = 4 \times 1 = 4$

$\therefore$  Co-ordinate of pt- is (4, 1)

If medium on both sides are same, then angle with which the ray enters the medium = angle with which the ray comes out.

$\therefore$  Ray will be parallel to x-axis.

Gravitation by Prof. Subhashish Chattopadhyay SKMClasses Bangalore Useful for IIT-JEE, CBSE, I.Sc. PU-II, Boards, CET, CEE, PET, IGCSE IB AP-Physics and other exams

A cubic container is filled with a liquid whose refractive index increases linearly from top to bottom. Which of the following represents the path of a ray of light inside the liquid?

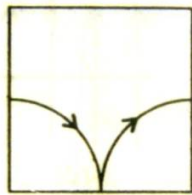

(a)

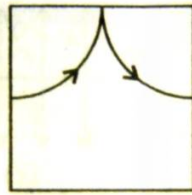

(b)

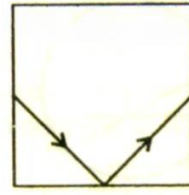

(c)

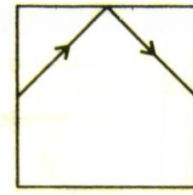

(d)

Since the refractive index is changing, the light cannot travel in a straight line in the liquid as shown in options (c) and (d). Initially, it will bend towards normal and after reflecting from the bottom it will bend away from the normal as shown in the figure.

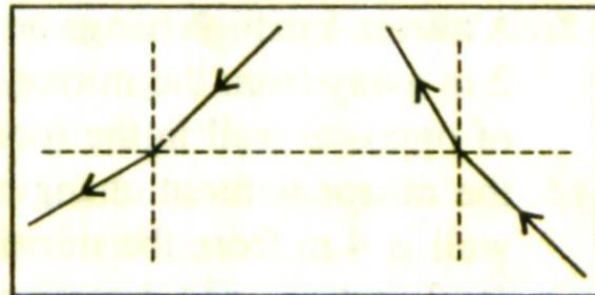

Optics - 24 ) Cylindrical lens ( IIT JEE 1999 )

A thin slice is cut out of a glass cylinder along a plane parallel to its axis. The slice is placed on a flat plate . The observed interference fringes from this combination shall be

1. Straight
2. Circular
3. Equally spaced
4. Having fringe spacing which increases as we go outwards

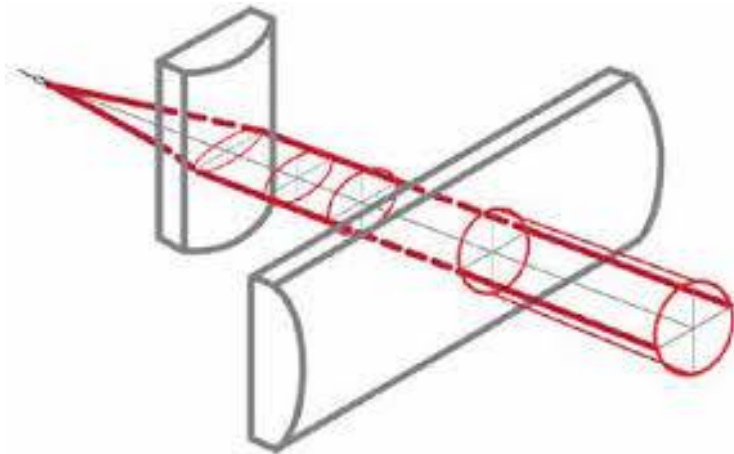

**Cylindrical Lens:** Cylindrical lens is a section of a cylindrical rod. One surface is cylindrical while the opposite is plane.

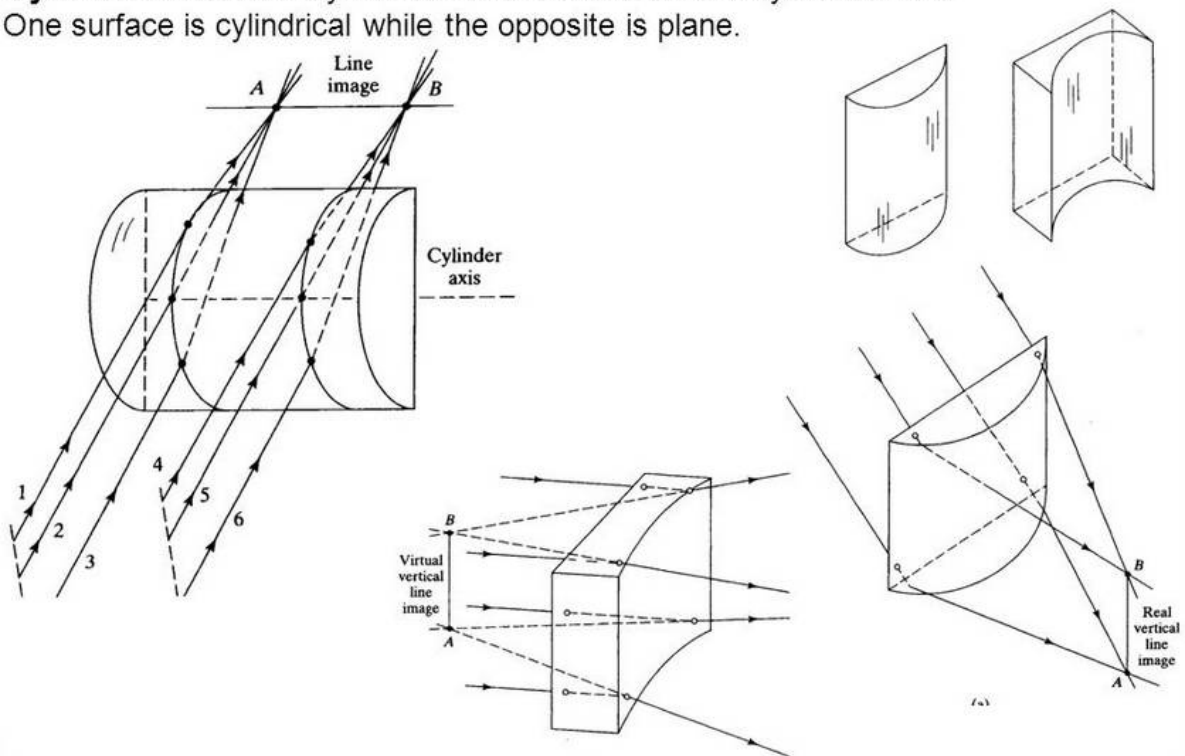



Optics - 25 ) Two lenses or mirrors whose axis is not coinciding ( IIT JEE 1993 ) Shifted lenses or mirrors

Two thin convex lenses of focal lengths  $f_1$  and  $f_2$  are separated by a horizontal distance  $d$  (where  $d < f_1, d < f_2$ ) and their centres are displaced by a vertical separation  $\Delta$  as shown in the figure. (1993)

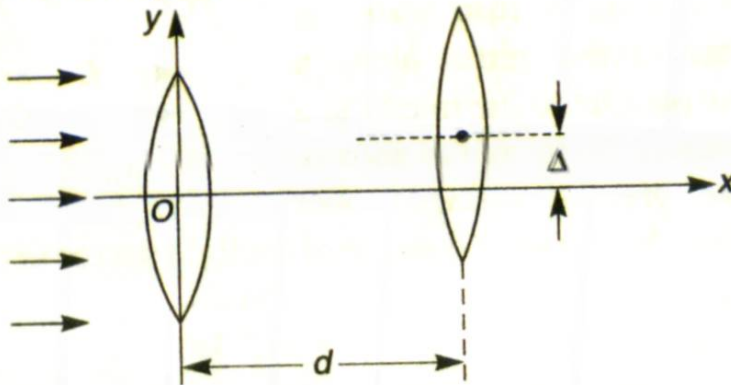

Taking the origin of coordinates,  $O$ , at the centre of the first lens, the  $x$  and  $y$ -coordinates of the focal point of this lens system, for a parallel beam of rays coming from the left, are given by (1993; 2M)

(a)  $x = \frac{f_1 f_2}{f_1 + f_2}, y = \Delta$

(b)  $x = \frac{f_1(f_2 + d)}{f_1 + f_2 - d}, y = \frac{\Delta}{f_1 + f_2}$

(c)  $x = \frac{f_1 f_2 + d(f_1 - d)}{f_1 + f_2 - d}, y = \frac{\Delta(f_1 - d)}{f_1 + f_2 - d}$

(d)  $x = \frac{f_1 f_2 + d(f_1 - d)}{f_1 + f_2 - d}, y = 0$

Solution

From the first lens parallel beam of light is focused at its focus *i.e.*, at a distance  $f_1$  from it. This image  $I_1$  acts as virtual object for second lens  $L_2$ . Therefore, for  $L_2$

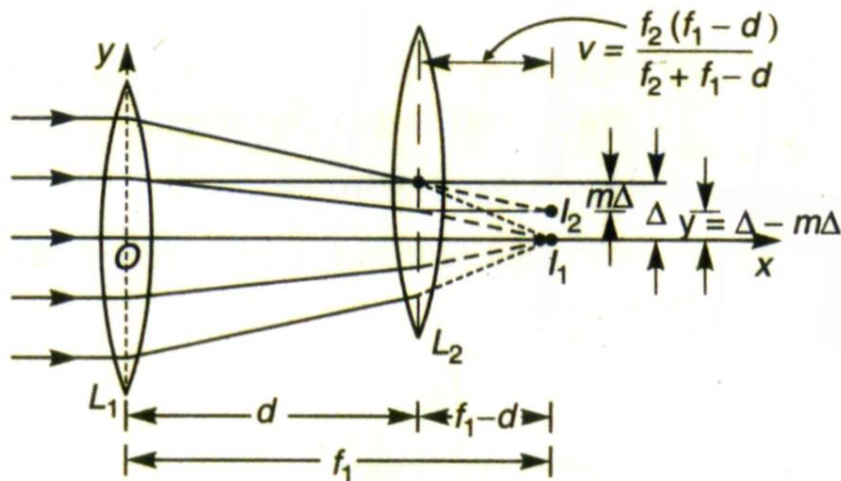

$$u = +(f_1 - d), f = +f_2$$

$$\therefore \frac{1}{v} = \frac{1}{f} + \frac{1}{u} = \frac{1}{f_2} + \frac{1}{f_1 - d}$$

<https://archive.org/details/IITJEE1993OpticsInterestingShiftedLensImageMagnificationAndPosition>

Find the co-ordinates of image of point object P formed after two successive reflection in situation as shown in fig. considering first reflection at concave mirror and then at convex mirror.

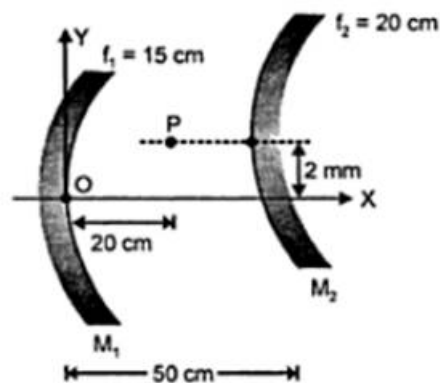

So  $f_1 = -15$  cm

$$v_1 = \frac{u \cdot f_1}{u - f_1} = \frac{(-20)(-15)}{-20 + 15}$$

or

$$v_1 = -60 \text{ cm}$$

$$\text{Magnification } (m_1) = -\frac{v_1}{u} = -\frac{-60}{-20} = -3 \quad (\text{Inverted})$$

$$\therefore A'P' = m_1 (AP) = 3 \times 2 = 6 \text{ mm}$$

For reflection at convex mirror  $M_2$

$$u = +10 \text{ cm}$$

$$f_2 = +20 \text{ cm}$$

$$v_2 = \frac{u \cdot f_2}{u - f_2} = \frac{(10)(20)}{10 - 20} = -20 \text{ cm}$$

$$\text{Magnification } m_2 = -\frac{v_2}{u} \Rightarrow -\frac{-20}{10} \Rightarrow 2$$

$$\therefore C'P' = m_2 (C'P) = 2 \times 8 = 16 \text{ mm}$$

So, the co-ordinate of image of point object P (30 cm, -14 mm).

Optics - 26 ) Painted lens or Combination of lenses where the last one is painted ( silvered )

If I am recalling correctly IIT JEE and other exams ( till 2016 ) had more than 10 questions of this kind. Most books do not discuss the easy formula of  $-1/F = 2/f_{L1} + 2/f_{L2} - 1/f_m$

( In 1990 I had derived this formula of my own for quick solving of this kind of problems )

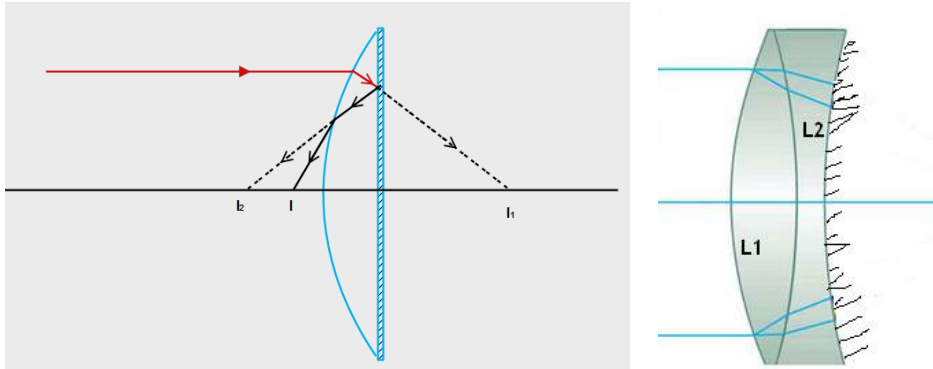

$F_m$  is focal length of the mirror as  $R/2$  +ve or -ve as per conditions

The plane face of a plano-convex lens is silvered. If  $\mu$  be the refractive index and  $R$ , the radius of curvature of curved surface, then the system will behave like a concave mirror of radius of curvature:

- (a)  $\mu R$  (b)  $R/(\mu - 1)$   
 (c)  $R^2/\mu$  (d)  $[(\mu + 1)/(\mu - 1)]R$

Solution :

Focal length of planar side is  $f_m = R/2 = -\infty$

$\frac{1}{f_l} = (\mu - 1) \left( \frac{1}{R} \right)$  by lens makers formula.  $R$  is positive because center of curvature is on right side

Use  $-1/F = 2/f_{L1} - 1/f_m$  or  $1/F = -\frac{2(\mu - 1)}{R}$  or  $F = \frac{-R}{2(\mu - 1)}$

$R$  (equivalent) =  $2F = \frac{-R}{(\mu - 1)}$

We don't have to use the formula  $-1/F = 2/f_{L1} + 2/f_{L2} - 1/f_m$  for every problem

See a Karnataka CET problem of 2004 ( Was also asked in IIT JEE and solved in "Concepts of Physics by Professor H C Verma )

A thin plano-convex lens acts like a concave mirror of focal length 0.2 m, when silvered on its plane surface. The refractive index of the material of lens is 1.5. The radius of curvature of the convex surface of the lens will be:

[CET (Karnataka) 2004]

- (a) 0.1 m      (b) 0.2 m      (c) 0.4 m      (d) 0.8 m

Solution :

Given focal length of mirror when its plane surface is silvered ( $f_m$ ) = 0.2 m. Radius of curvature of curved surface ( $R_1$ ) =  $R$ ; radius of curvature of plane side ( $R_2$ ) =  $\infty$ ; refractive index of the material of lens ( $\mu$ ) = 1.5.

Since a thin plano-convex lens acts like a concave mirror when silvered on its plane surface, therefore focal length of lens ( $f$ ) =  $2 \times f_m = 2 \times 0.2 = 0.4$  m.

We know that

$$\frac{1}{f} = (\mu - 1) \left( \frac{1}{R_1} - \frac{1}{R_2} \right)$$

or

$$\frac{1}{0.4} = (1.5 - 1) \left( \frac{1}{R} - \frac{1}{\infty} \right) = \frac{0.5}{R}$$

$\therefore$              $R = 0.2 \text{ m}$

IIT JEE 2006

A point object is placed at a distance of 20 cm from a thin planoconvex lens of focal length 15 cm. The plane surface of the lens is now silvered. The image created by the system is at (2006, 3M)

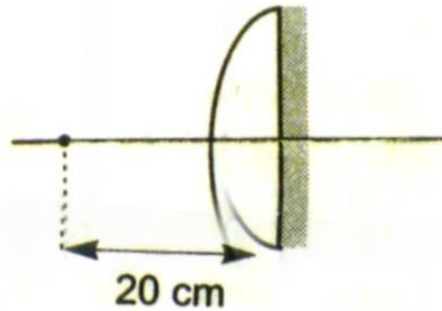

- (a) 60 cm to the left of the system
- (b) 60 cm to the right of the system
- (c) 12 cm to the left of the system
- (d) 12 cm to the right of the system

Solution :

Long method

$$\text{Refraction from lens : } \frac{1}{v_1} - \frac{1}{-20} = \frac{1}{15}$$

$$\therefore v = 60 \text{ cm} \quad \xrightarrow{\text{+ ve direction}}$$

ie, first image is formed at 60 cm to the right of lens system.

**Reflection from mirror**

After reflection from the mirror, the second image will be formed at a distance of 60 cm to the left of lens system.

**Refraction from lens**

$$\frac{1}{v_3} - \frac{1}{60} = \frac{1}{15} \quad \xleftarrow{\text{+ ve direction}}$$

or  $v_3 = 12 \text{ cm}$

Therefore, the final image is formed at 12 cm to the left of the lens system.

Shorter Method

$$\frac{1}{f} = (\mu - 1) \left( \frac{1}{R_1} - \frac{1}{R_2} \right)$$

$$\text{Use } F = \frac{-R}{2(\mu - 1)} \quad \text{and} \quad (1.5 - 1) \left( \frac{1}{R} - \frac{1}{\infty} \right) = \frac{0.5}{R} = 1/(2R)$$

$$1/15 = 1/2R \Rightarrow 15 = 2R \Rightarrow R = 7.5 \text{ cm}$$

$$F = -7.5 / (2 \times 0.5) = -7.5 = -15/2$$

Using  $1/v + 1/u = 1/F$  for equivalent mirror

$$1/v + 1/(-20) = 1/(-7.5)$$

$$\Rightarrow 1/v = 1/20 - 2/15 = (3 - 8)/60 = -5/60 = -1/12$$

$$\Rightarrow v = -12 \text{ cm}$$

Even more shorter method

If I am appearing for an exam I would have done  $-1/F = 2/f_{L1} - 1/f_m$

$$\text{So } -1/F = 2/(15) - 1/(\infty) = 1/7.5 - 0 \Rightarrow F = -7.5 \text{ cm}$$

Then Using  $1/v + 1/u = 1/F$  for equivalent mirror

$$1/v + 1/(-20) = 1/(-7.5)$$

$$\Rightarrow 1/v = 1/20 - 2/15 = (3 - 8)/60 = -5/60 = -1/12$$

$$\Rightarrow v = -12 \text{ cm}$$

-

IIT JEE 1978

**A pin is placed 10 cm in front of a convex lens of focal length 20 cm and made of a material of refractive index 1.5. The convex surface of the lens farther away from the pin is silvered and has a radius of curvature of 22 cm. Determine the position of the final image. Is the image real or virtual? (1978)**

Let us use  $-1/F = 2/f_{L1} - 1/f_m$

And  $\frac{1}{f} = (\mu - 1) \left( \frac{1}{R_1} - \frac{1}{R_2} \right)$  giving  $1/20 = 0.5 ( 1/R_1 - 1/(-22) )$  or  $R_1 = 55/3$

$R_1$  actually is not required. We can find  $f_m$  as  $R_2 / 2 = - 11$  cm

So  $- 1/F = 2/20 - 1/(-11) = 1/10 + 1/11 = 21/110$

or  $F = - 110/21$  ( not required !  $1/F = -21/110$  is enough )

Using mirror formula  $1/v + 1/u = 1/F$

So  $1/v + 1 / (-10) = -21/110$

$\Rightarrow 1/v = 1/10 - 21/110 = ( 11 - 21 )/110 = -10/110 = -1/11$

$\Rightarrow v = -11$  cm

virtual image on left at 11 cm

( Now do you guys see that even though we got problems of this kind since 1978 and before, but yet the formula is not there in every book ! )

-

IIT JEE 1979

**The radius of curvature of the convex face of a planoconvex lens is 12 cm and its  $\mu = 1.5$ .**

**(a) Find the focal length of the lens. The plane face of the lens is now silvered.**

**(b) At what distance from the lens will parallel rays incident on the convex surface converge ?**

**(c) Sketch the ray diagram to locate the image, when a point object is placed on the axis 20 cm from the lens.**

**(d) Calculate the image distance when the object is placed as in (c)**

**(1979)**



Now you know that this problem can be solved by 3 different ways.

The longest method being successive image method. Meaning find the first image due to lens, then 2<sup>nd</sup> image due to silvered surface as mirror. The 3<sup>rd</sup> and final image is due to light travelling from right to left through the lens again.

I will discuss the shorter methods

$$\begin{aligned}
 \text{(a)} \quad \frac{1}{f} &= (\mu - 1) \left( \frac{1}{R_1} - \frac{1}{R_2} \right) \\
 &= (1.5 - 1) \left( \frac{1}{12} - \frac{1}{\infty} \right) \\
 &= \frac{1}{24} \\
 \therefore f &= +24 \text{ cm}
 \end{aligned}$$

(b) use  $-1/F = 2/f_L$  so  $F = -12$  cm

The system will act as a concave mirror of focal length 12 cm. The parallel rays will converge at 12 cm left of this silvered lens.

(c)

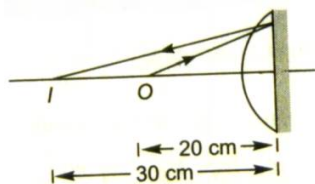

(d)

**Using mirror formula**

$$\frac{1}{v} - \frac{1}{20} = \frac{-1}{12}$$

**Solving we get  $v = -30$  cm.**

**Therefore the image will be formed at a distance of 30 cm to the left of system.**

IIT JEE 1981

The convex surface of a thin concavo-convex lens of glass of refractive index 1.5 has a radius of curvature

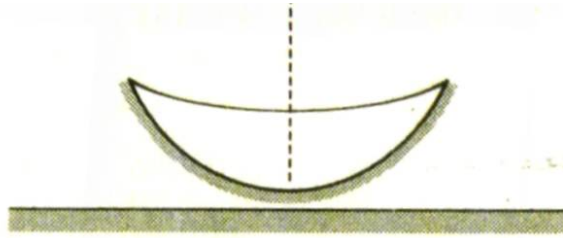

20 cm. The concave surface has a radius of curvature 60 cm. The convex side is silvered and placed on a horizontal surface. **(1981, 2M)**

- Where should a pin be placed on the optic axis such that its image is formed at the same place?
- If the concave part is filled with water of refractive index  $4/3$ , find the distance through which the pin should be moved, so that the image of the pin again coincides with the pin.

I will prefer to solve this by  $-1/F = 2/f_{L1} + 2/f_{L2} - 1/f_m$  ( note it was a 2 marks problem )

While for practice and to know how successive image method of solving works see ...

Image of object will coincide with it if ray of light after refraction from the concave surface fall normally on concave mirror so formed by silvering the convex surface. Or image after refraction from concave surface should form at centre of curvature of concave mirror or at a distance of 20 cm on same side of the combination. Let  $x$  be the distance of pin from the given optical system.

Applying.

$$\frac{\mu_2}{v} - \frac{\mu_1}{u} = \frac{\mu_2 - \mu_1}{R}$$

With proper signs

$$\frac{1.5}{-20} - \frac{1}{-x} = \frac{1.5 - 1}{-60}$$

or 
$$\frac{1}{x} = \frac{3}{40} - \frac{1}{120} = \frac{8}{120}$$

$\therefore x = \frac{120}{8} = 15 \text{ cm}$

(b)

Now, before striking with the concave surface, the ray is first refracted from a plane surface. So, let  $x$  be the distance of pin, then the plane surface will form its image at a distance  $\frac{4}{3}x$  ( $h_{\text{app.}} = \mu h$ ) from it.

Now, using  $\frac{\mu_2}{v} - \frac{\mu_1}{u} = \frac{\mu_2 - \mu_1}{R}$  with proper signs,

we have 
$$\frac{1.5}{-20} - \frac{4/3}{-4x} = \frac{1.5 - 4/3}{-60}$$

or 
$$\frac{1}{x} = \frac{3}{40} - \frac{1}{360}$$

or 
$$x = 13.84 \text{ cm}$$

$\therefore \Delta x = x_1 - x_2$   
 $= 15 \text{ cm} - 13.84 \text{ cm}$   
 $= 1.16 \text{ cm} \quad \text{(downwards)}$

Now can you guys check the results using  $-1/F = 2/f_{L1} + 2/f_{L2} - 1/f_m$

A plano-convex lens of refractive index 1.5 and radius of curvature 30 cm is silvered at the curved surface. Now this lens has been used to form the image of an object. At what distance from this lens an object be placed in order to have a real image of the size of the object? (AIEEE 2004)

- (a) 20 cm                      (b) 30 cm  
(c) 60 cm                      (d) 80 cm

Solution :

To obtain the real image of the size of the object, the object must be placed at the centre of curvature of the equivalent mirror formed as a result of silvering

$$\frac{1}{F} = \frac{2}{f_l} + \frac{1}{f_m}$$

$$\text{and } \frac{1}{f_l} = (1.5 - 1) \left( \frac{1}{\infty} - \frac{1}{-30} \right) = \frac{1}{60}$$

$$\text{and } f_m = 15 \text{ cm}$$

$$\therefore F = 10 \text{ cm}$$

Hence, object should be placed at 20 cm from the lens because radius of curvature of equivalent mirror =  $2F = 2 \times 10 = 20$  cm. Hence, option (a) is correct.

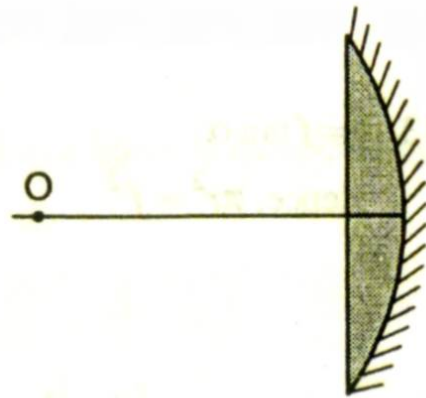

Video explanations of Painted or Silvered lenses

<https://archive.org/details/PaintedLensIITJEEProblemImageNeedsToCoincideWithObjectHCVermaPart1>

Optics - 27 ) Image speed when object is moving as seen from various mirrors and lenses

( concave, convex, silvered etc )

Mirror formula (  $1/v + 1/u = 1/f$  ) or Lens formula (  $1/v - 1/u = 1/f$  ) have to be differentiated to find  $du/dt$  or  $dv/dt$

A luminous point is moving at speed  $v_0$  towards a spherical mirror, along its axis. Then the speed at which the image of this point object is moving is given by: (with  $R$  = radius of curvature and  $u$  = object distance)

(a)  $v_i = -v_0$                       (b)  $v_i = -v_0 \left( \frac{R}{2u - R} \right)$   
(c)  $v_i = -v_0 \left( \frac{2u - R}{R} \right)$                       (d)  $v_i = -v_0 \left( \frac{R}{2u - R} \right)^2$

$$\frac{1}{v} + \frac{1}{u} = \frac{1}{f} \quad \text{or} \quad -\frac{1}{v^2} \frac{dv}{dt} - \frac{1}{u^2} \frac{du}{dt} = 0$$

$$\therefore \quad \frac{dv}{dt} = v_i = -\left(\frac{v}{u}\right)^2 \frac{du}{dt} = -\left(\frac{v}{u}\right)^2 v_0$$

Now,  $\frac{1}{v} = \frac{1}{f} - \frac{1}{u} = \frac{2}{R} - \frac{1}{u} = \frac{2u - R}{Ru}$

$$\therefore \quad v = \frac{uR}{2u - R}$$

$$\therefore \quad v_i = -\left(\frac{v}{u}\right)^2 v_0 = -v_0 \left(\frac{R}{2u - R}\right)^2$$

Optics - 28 ) Slab with a hole or gap, then may be filled with liquid etc

Given  ${}^a\mu_g = 3/2$  and  ${}^a\mu_w = 4/3$ . There is an equiconvex lens with radius of each surface equal to 20 cm. There is air in the object space and water in the image space. The focal length of lens is:

- (a) 80 cm      (b) 40 cm      (c) 20 cm      (d) 10 cm

Solution :

$$\begin{aligned}\frac{{}^a\mu_w}{f} &= \frac{({}^a\mu_g - 1)}{R_1} - \frac{({}^a\mu_g - {}^a\mu_w)}{R_2} \\ &= \frac{\left(\frac{3}{2} - 1\right)}{20} - \frac{\left(\frac{3}{2} - \frac{4}{3}\right)}{-20} = \frac{1}{40} + \frac{1}{120} = \frac{1}{30} \\ f &= \frac{4}{3} \times 30 = 40 \text{ cm}\end{aligned}$$

Optics - 29 ) Constraint in interference conditions

Two identical coherent sources are placed on a diameter of a circle of radius  $R$  at separation  $x$  ( $\ll R$ ) symmetrically about the centre of the circle. The sources emit identical wavelength  $\lambda$  each. The number of points on the circle with maximum intensity is: ( $x = 5\lambda$ )

- (a) 20      (b) 22      (c) 24      (d) 26

Solution :

Path difference at  $P$  is

$$\Delta x = 2 \left( \frac{x}{2} \cos \theta \right) = x \cos \theta$$

For intensity to be maximum,

$$\Delta x = n\lambda$$

$$(n = 0, 1, 2, \dots)$$

$$\therefore x \cos \theta = n\lambda$$

$$\cos \theta = \frac{n\lambda}{x}$$

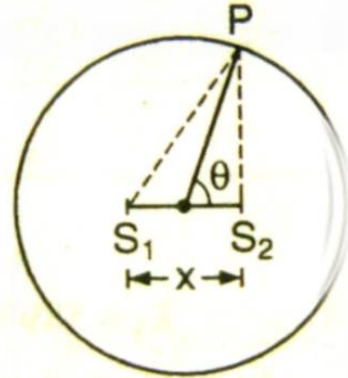

$$\cos \theta \neq 1$$

$$\therefore \frac{n\lambda}{x} \neq 1$$

$$\therefore n \neq \frac{x}{\lambda}$$

Putting  $x = 5\lambda$ ,  $n \neq 5$

or  $n = 1, 2, 3, 4, 5$

Therefore in all four quadrants there can be 20 maximas. There are

more maximas at  $\theta = 0^\circ$  and  $\theta = 180^\circ$ .

But  $n = 5$  corresponds to  $\theta = 90^\circ$  and  $\theta = 270^\circ$  which are coming only twice while we have multiplied it four times. Therefore, total number of maximas are still 20, i.e.,  $n = 1$  to 4 in four quadrants (total 16) plus four more at  $\theta = 0^\circ, 90^\circ, 180^\circ$  and  $270^\circ$ .

If two coherent sources are placed at a distance  $3\lambda$  from each other symmetric to the centre of the circle shown in the figure, then number of fringes shown on the screen placed along the circumference is: **(UPSEAT 2002)**

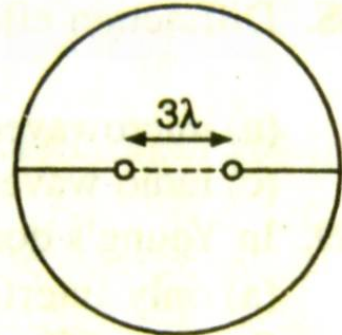

- (a) 16
- (b) 12
- (c) 8
- (d) 4

Answer ( b ) See above Solution

White light is used to illuminate the two slits in a Young's double slit experiment. The separation between the slits is  $b$  and the screen is at a distance  $d$  ( $\gg b$ ) from the slits. At a point on the screen directly in front of one of the slits, certain wavelengths are missing. Some of these missing wavelengths are: **[CET (J&K) 2003; PET (Kerala) 2006]**

- (a)  $\lambda = 3b^2/d$
- (b)  $\lambda = 2b^2/d$
- (c)  $\lambda = b^2/3d$
- (d)  $\lambda = 2b^2/3d$



Solution :

$$\text{Path difference} = (S_2P - S_1P)$$

$$\text{From figure, } (S_2P)^2 - (S_1P)^2 = b^2$$

$$\text{or } (S_2P - S_1P)(S_2P + S_1P) = b^2$$

$$\text{or } (S_2P - S_1P) = \frac{b^2}{2d}$$

$$\text{For dark fringes, } \frac{b^2}{2d} = (2n + 1) \frac{\lambda}{2}$$

$$\text{For } n = 0, \quad \frac{b^2}{2d} = \frac{\lambda}{2} \quad \text{or } \lambda = \frac{b^2}{d}$$

$$\text{For } n = 1, \quad \frac{b^2}{2d} = \frac{3\lambda}{2} \quad \text{or } \lambda = \frac{b^2}{3d}$$

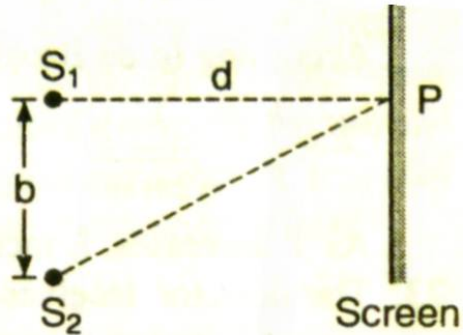

Optics - 30 ) Silvered Prisms or Painted Prisms

If one face of a prism of prism angle  $30^\circ$  and  $\mu = \sqrt{2}$  is silvered, the incident ray retraces its initial path. The angle of incidence is:

- (a)  $60^\circ$       (b)  $30^\circ$       (c)  $45^\circ$       (d)  $90^\circ$

Solution : ( c )

It is clear from the figure that the ray will retrace the path when the refracted ray  $QR$  is incident normally on the polished surface  $AC$ . Thus, angle of refraction  $r = 30^\circ$ .

We know that  $\mu = \sin i / \sin r$

$$\therefore \sin i = \mu \sin r$$

$$= \sqrt{2} \times \sin 30^\circ = \sqrt{2} \times \frac{1}{2}$$

$$= (1/\sqrt{2})$$

$$\therefore i = 45^\circ$$

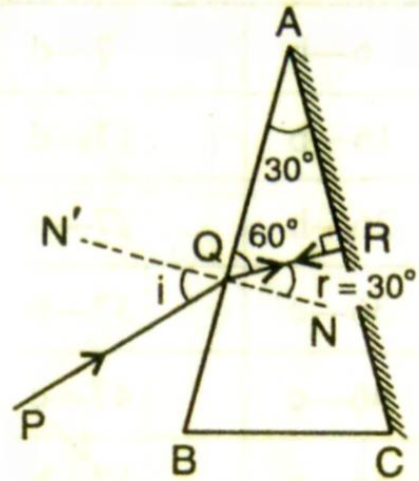

Optics - 31 ) A slab is silvered on one side or Painted on one side

A plane mirror is made of a glass slab ( $\mu_g = 1.5$ ) 2.5 cm thick and silvered on its back. A point object is placed 5 cm in front of the unsilvered face of the mirror. What will be the position of the final image?

- (a) 12 cm from unsilvered face
- (b) 14.6 cm from unsilvered face
- (c) 5.67 cm from unsilvered face
- (d) 8.33 cm from unsilvered face

Solution : ( d )

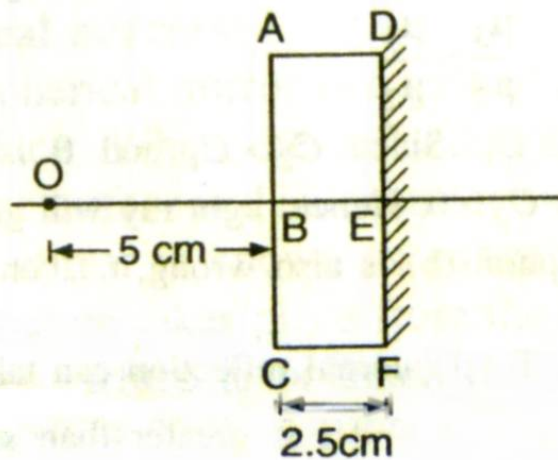

Let  $I_1$ ,  $I_2$  and  $I_3$  be the images formed by

- (i) refraction from  $ABC$
- (ii) reflection from  $DEF$  and
- (iii) again refraction from  $ABC$

Then  $BI_1 = (5)\mu_g = 5 \times 1.5 = 7.5 \text{ cm}$

Now  $EI_1 = 7.5 + 2.5 = 10 \text{ cm}$

$\therefore EI_2 = 10 \text{ cm}$  behind the mirror

Now,  $BI_2 = (10 + 2.5) = 12.5 \text{ cm}$

$\therefore BI_3 = \frac{12.5}{\mu_g} = \frac{12.5}{1.5} = 8.33 \text{ cm}$

### Real and apparent depth:

- (i) When one looks into a pool of water, it does not appear to be as deep as it really is. Also when one looks into a slab of glass, the material does not appear to be as thick as it really is. This all happens due to refraction of light.
- ii) If a beaker is filled with water and a point lying at its bottom is observed by someone located in air, then the bottom point appears raised. The apparent depth  $t_{ap}$  is less than the actual depth  $t_{ac}$ . It can be shown that

$$\text{apparent depth } (t_{ap}) = \frac{\text{actual depth } (t_{ac})}{\text{refractive index } (n)}$$

iii )

If there is an ink spot at the bottom of a glass slab, it appears to be raised by a distance

$$d = t_{ac} - t_{ap} = t - \frac{t}{n} = t \left( 1 - \frac{1}{n} \right)$$

where  $t$  is the thickness of the glass slab and  $n$  is its refractive index.

iv )

If a beaker is filled with immiscible transparent liquids of refractive indices  $n_1, n_2, n_3$  and individual depth  $d_1, d_2, d_3$  respectively, then the apparent depth of the beaker is found to be:

$$t_{\text{ap}} = \frac{d_1}{n_1} + \frac{d_2}{n_2} + \frac{d_3}{n_3}$$

Consider the situation shown in figure. Water ( $\mu_w = 4/3$ ) is filled in a beaker upto a height of 10 cm. A plane mirror is fixed at a height of 5 cm from the surface of water. Distance of image from the mirror after reflection from it of an object  $O$  at the bottom of the beaker is:

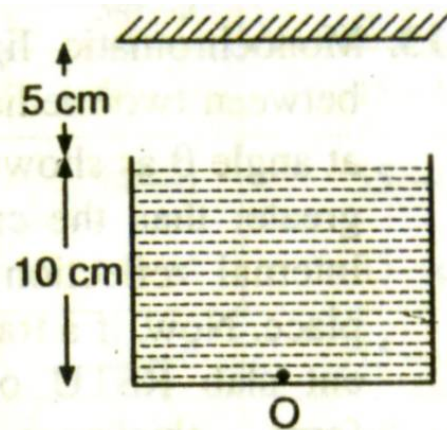

- (a) 15 cm                                      (b) 12.5 cm  
 (c) 7.5 cm                                     (d) 10 cm

Solution : ( b )

Distance of first image ( $I_1$ ) formed after refraction from the plane surface of water is =  $\frac{10}{4/3} = 7.5$  cm from water surface

$$\left[ \because d_{\text{app}} = \frac{d_{\text{actual}}}{\mu} \right]$$

Now distance of this image is  $5 + 7.5 = 12.5$  cm from the plane mirror. Therefore, distance of second image ( $I_2$ ) will also be equal to 12.5 cm from the mirror.

A beaker containing liquid is placed on a table, underneath a microscope which can be moved along a vertical scale. The microscope is focussed through the liquid on to a mark on

the table when the reading on the scale is  $a$ . It is next focussed on the upper surface of the liquid and the reading is  $b$ . More liquid is added and the observations are repeated, the corresponding readings are  $c$  and  $d$ . The refractive index of the liquid is:

- (a)  $\frac{d-b}{d-c-b+a}$                       (b)  $\frac{b-d}{d-c-b+a}$   
(c)  $\frac{d-c-b+a}{d-b}$                         (d)  $\frac{d-b}{a+b-c-d}$

Solution : (a)

The real depth = R.I.  $\times$  apparent depth

In first case,

The real depth  $h_1 = n(b - a)$

Similarly, in the second case, the real depth  $h_2 = n(d - c)$

Since,  $h_2 > h_1$ , the difference of real depths

$$= h_2 - h_1 = n(d - c - b + a)$$

Since the liquid is added in second case,

$$h_2 - h_1 = d - b$$

$$\therefore n = \frac{d - b}{d - c - b + a}$$

Optics - 32 ) In YDSE experiment the light falls at an angle on 2 slits

**Example:** Recalculate the angular spread to the above problem if the incidence is at an angle of  $15^\circ$  with the normal to the plane of the slit.

**Solution.** (a) Let us first consider a point P (above centre O of the screen) on the screen as shown in Fig. From B, drop a perpendicular  $BN'$ . From A, drop a perpendicular  $AN$  on BP. If first minimum is formed at P, then the corresponding path difference is given by

$$BN - AN' = \lambda$$

$$BN - AN' = \lambda$$

or  $d \sin \theta_1 - d \sin 15^\circ = \lambda$

or  $\sin \theta_1 - \sin 15^\circ = \frac{\lambda}{d} = \frac{2 \text{ cm}}{5 \text{ cm}} = 0.4$

or  $\sin \theta_1 = 0.4 + \sin 15^\circ = 0.4 + 0.2588 = 0.6588$

or  $\theta_1 = \sin^{-1}(0.6588) = 41^\circ 13'$  (from tables of natural sines)

(b) Let us now consider a point P' below O. Let the first minimum be at P'. Then, the corresponding path difference is given by

$$N'A + AN = \lambda \quad \text{or} \quad d \sin 15^\circ + d \sin \theta_2 = \lambda$$

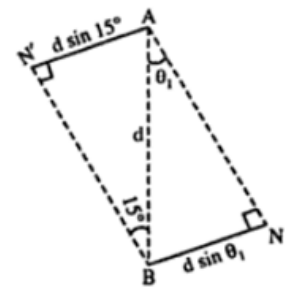
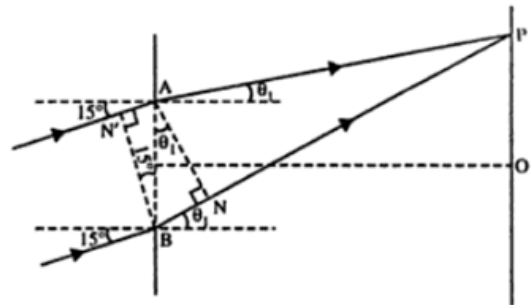

Optics - 33 ) Diffraction Grating

**Example** A diffraction grating one cm wide has 1000 lines and is used in third order. What are the diffraction angles for violet and orange light? What is the angular size of the diffraction maximum for monochromatic light? The wavelengths for violet and orange are 400 nm and 600 nm respectively.

**Solution.** For third order,  $n = 3$ ,  $\theta_v = \frac{3 \times 4 \times 10^{-7}}{10^{-5}} \text{ rad} = 12 \times 10^{-2} \text{ rad} = 6.9^\circ$   
 $\theta_o = 18 \times 10^{-2} \text{ rad} = 10.3^\circ$

The spectrum is thus spread over an angle of nearly  $3.4^\circ$ .

At a maximum, we have  $\theta = \frac{3\lambda}{d}$

The path difference between the first and the last slit in the grating is an integral number of wavelengths. Let us increase  $\theta$  so that an extra path difference of  $\lambda$  is introduced across the width  $w$ . The change in  $\theta$  required to do this is denoted by  $\Delta\theta$ .

$$\Delta\theta = \frac{\lambda}{w}$$

Because of the  $360^\circ$  extra phase across the grating, we can again divide it into two halves so that there is a  $180^\circ$  phase difference between slits separated by  $w/2$ . So, we get zero intensity at

$$\Delta\theta = \frac{\lambda}{w} = \frac{4 \times 10^{-7}}{10^{-2}} \text{ rad} = 4 \times 10^{-5} \text{ rad} = 2.3 \times 10^{-3} \text{ degrees for violet light}$$

The maximum is sufficiently sharp

Optics - 34 ) Interference with equations

**Two coherent waves are described by the expressions.**

$$E_1 = E_0 \sin\left(\frac{2\pi x_1}{\lambda} - 2\pi ft + \frac{\pi}{6}\right) ; \quad E_2 = E_0 \sin\left(\frac{2\pi x_2}{\lambda} - 2\pi ft + \frac{\pi}{8}\right)$$

**Determine the relationship between  $x_1$  and  $x_2$  that produces constructive interference when the two waves are superposed?**

**Sol.** In interference,  $E_r = E_1 + E_2$  (by superposition principle)

$$\phi_1 = \frac{2\pi x_1}{\lambda} - 2\pi ft + \frac{\pi}{6} \quad ; \quad \phi_2 = \frac{2\pi x_2}{\lambda} - 2\pi ft + \frac{\pi}{8}$$

$$\text{Phase difference at } t=0, \quad \Delta\phi = \left(\frac{2\pi x_1}{\lambda} + \frac{\pi}{6}\right) - \left(\frac{2\pi x_2}{\lambda} + \frac{\pi}{8}\right)$$

$$\text{For constructive interference, } \Delta\phi = \pm 2n\pi \quad (\text{where } n = 0, 1, 2, 3, \dots)$$

$$\Rightarrow \pm 2n\pi = \frac{2\pi}{\lambda}(x_1 - x_2) + \frac{\pi}{24} \Rightarrow \pm \left(n - \frac{1}{48}\right)\lambda = (x_1 - x_2)$$

$$\text{[Ans. } \left(n - \frac{1}{48}\right)\lambda = x_1 - x_2]$$



Optics - 35 ) f number of a camera

Focal number of the lens of a camera is  $5f$  and that of another is  $2.5f$ . The time of exposure for the second

is..... if that for the first is  $\frac{1}{200} s$

$$\left( \text{Given } f = \frac{\text{focal length}}{\text{aperature}} \right)$$

(a)  $\frac{1}{200} s$

(b)  $\frac{1}{800} s$

(c)  $\frac{1}{3200} s$

(d)  $\frac{1}{6400} s$

[BHU 2005]

**Solution** (b)  $f$  number decreases by 2  $\therefore$  time of exposure should decrease by  $(2^2)$ .

$$\therefore t_{\text{new}} = \frac{1}{4} \times \frac{1}{200} = \frac{1}{800} s.$$

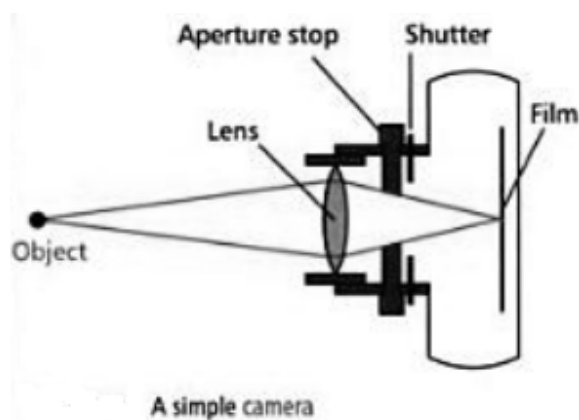

Gravitation by Prof. Subhashish Chattopadhyay SKMClasses Bangalore Useful for IIT-JEE, CBSE, I.Sc. PU-II, Boards, CET, CEE, PET, IGCSE IB AP-Physics and other exams

If  $n_1$  and  $n_2$  are f-numbers of two cameras and  $t_1$  and  $t_2$  are the exposure times then  $(t_1 / t_2) = (n_1 / n_2)^2$

The f-number of a camera lens is defined as  $n = f / D$

where  $D$  = diameter of the camera lens

and  $f$  = focal length

**The illumination at the film is proportional to square of diameter of the aperture, and inversely proportional to area of the image. Therefore, if the aperture is circular and of diameter  $D_a$ , and the image**

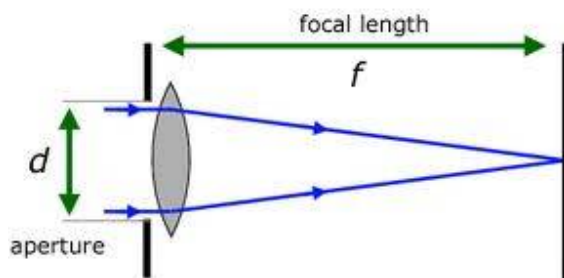

Gravitation by Prof. Subhashish Chattopadhyay SKMClasses Bangalore Useful for IIT-JEE, CBSE, I.Sc. PU-II, Boards, CET, CEE, PET, IGCSE IB AP-Physics and other exams

is a disc of diameter  $D_i$ , then the illumination  $I_f$  on the film is,

$$I_f \propto \frac{\text{area of aperture}}{\text{area of image}} \\ \propto (D_a/D_i)^2$$

Since the image size is directly proportional to focal length  $f$ ,

$$I_f \propto (D_a/f)^2 \\ \propto 1/N^2$$

Thus, smaller the  $f$ -number  $N$  the greater is the brightness of the image, and, hence, the smaller is the exposure time (or higher is the shutter speed). The maximum diameter of the aperture is equal to the diameter of the lens. Thus the minimum possible value of  $N$  is,

$$N_{\min} = \frac{\text{focal length of the lens}}{\text{diameter of the lens}}$$

This value of  $N$  is, therefore, called the  $f$ -number (or the speed or the fastness) of the lens. The lenses are usually specified as : 50 mm  $f/1.4$ , 135 mm  $f/3.5$ , 85-210 mm  $f/4.5$ , etc. It is easier to get small  $f$ -number in amateur cameras. In these cameras the lens focal length and diameter are small. Therefore, high quality optical blank needed to fabricate a lens is of smaller size and thus less expensive.

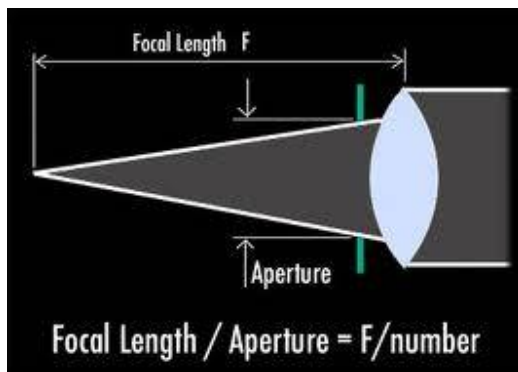
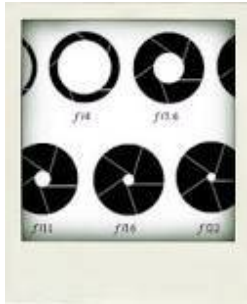

As  $I_f \propto 1/N^2$ , in most cameras several choices of  $N$  are available which change  $I_f$  by a factor of two at each step. The corresponding  $f$ -numbers then form a geometrical series with a ratio of  $\sqrt{2}$ , e.g., 1.4, 2, 2.8, 4, 5.6, 8, 11, 16, 22. It starts with the minimum  $N$ , the  $f$ -number of the lens. For example, if  $f = 50$  mm and lens diameter is 36 mm, the starting  $f$ -number is 1.4. As the smaller the  $f$ -number the higher is the shutter speed, *the lens having smaller starting  $f$ -number will be faster.*

**An aperture stop** is a feature of a good camera. It can be adjusted to allow more or less light through onto the film. For high-speed photography, the shutter is opened for a very short time only, so the aperture needs to be wide open to let as much light through in that short time. Otherwise the image will be too faint. For a given shutter speed, the  $f$ -number setting controls the amount of light reaching the film. The  $f$ -number setting determines the area of the aperture on a scale such that the width of the aperture equals the focal length/the  $f$ -number. To widen the aperture, the  $f$ -number should therefore be decreased. For example, if the aperture setting on a camera is changed from  $f/4$  to  $f/8$ , this means the aperture is narrowed from one-quarter to one-eighth of the focal length.

The practical scale of  $f$ -numbers on most cameras is given below. The reason for this scale is that the area of the aperture (which is proportional to the square of the width) is either approximately doubled or halved when the  $f$ -number is changed from one setting to the next.

$f$ -number	2	2.8	4	5.6	8	11	16	22	32
Aperture width	$f/2$	$f/2.8$	$f/4$	$f/5.6$	$f/8$	$f/11$	$f/16$	$f/22$	$f/32$
Aperture area (relative)	$\frac{1}{4}$	$\frac{1}{7.5}$	$\frac{1}{16}$	$\frac{1}{31.4}$	$\frac{1}{64}$	$\frac{1}{121}$	$\frac{1}{256}$	$\frac{1}{484}$	$\frac{1}{1024}$

**The depth of field** is affected by the aperture width. When an object is photographed, other objects in view will also be on the same photograph.

The **depth of field** is the range of object distances which give a sharp image on a film at a fixed distance from the lens.

The **depth of focus** is the range of image distances which give a sharp image on a film of an object at fixed distance from the lens.

$$f\text{-number} = \frac{f}{D}$$

A larger aperture (a larger value of  $D$ ) lets more light reach the CCD and gives a smaller  $f$ -number. A large  $f$ -number (small  $D$ ) allows less light to get to the CCD. To have a properly exposed photograph (not too bright and not too dark), the total light energy must lie within a certain range. If you reduce the shutter speed and thus keep the shutter open longer, you must compensate by using a smaller aperture and hence a larger  $f$ -number.

#### CONCEPT CHECK

#### Aperture and Shutter Speed for a Camera

A photographer is taking photos using an  $f$ -number of 4 and a shutter speed setting that keeps the aperture open for  $1/100 = 0.010$  s. The photographer then changes the  $f$ -number to 16. How long should the shutter now be open so as to have the same amount of light energy reach the detector, (a) the same amount of time, (b) 0.0025 s, (c) 0.04 s, or (d) 0.16 s?

-  
Modern Physics 1 ) Spallation reactions ( MP-PET-2002 Madhya Pradesh Pre Engineering Test )

See <http://skmclasses.weebly.com/spallation-reaction.html>

-  
Modern Physics 2 ) Ruby LASER ( asked in COMED-K Karnataka )

See <http://skmclasses.weebly.com/ruby-laser.html>

-  
Modern Physics 3 ) Various details in Particle Physics ( asked in several state exams, including Karnataka CET and COMED-K )

See <http://skmclasses.weebly.com/particle-physics.html>

-  
Modern Physics 4 ) "Magic Numbers" and "Doubly Magic Numbers" in Nuclear Isotope Stability

See <http://skmclasses.weebly.com/magic-number-doubly-magic-in-nucleus.html>

-  
Modern Physics 5 ) Every Alpha (  $\alpha$  ) decay produces an isodiapher. Meaning isodiaphers are extremely common. There was AIEEE question on isodiaphers. Also asked in many other

Gravitation by Prof. Subhashish Chattopadhyay SKMClasses Bangalore Useful for IIT-JEE, CBSE, I.Sc. PU-II, Boards, CET, CEE, PET, IGCSE IB AP-Physics and other exams

exams. Even though every book talks of  $\alpha$ ,  $\beta$ , and  $\gamma$  decay; most do not talk about isodiaphers, and positron decay. I find this very strange or rather weird !

In nuclear physics, **isodiaphers** refers to nuclides which have different atomic numbers and mass numbers but the same neutron excess, which is the difference between numbers of neutrons and protons in the nucleus. For example, for both  ${}_{90}^{234}\text{Th}$  and  ${}_{92}^{238}\text{U}$  the difference between the neutron number ( $N$ ) and proton number ( $Z$ ) is  $N - Z = 54$ .

One large family of isodiaphers has zero neutron excess,  $N = Z$ . It contains many primordial isotopes of elements up to calcium. It includes ubiquitous  ${}_{6}^{12}\text{C}$ ,  ${}_{8}^{16}\text{O}$ , and  ${}_{7}^{14}\text{N}$ .

The daughter nuclide of an alpha decay is an isodiapher of the original nucleus. Similarly, beta decays (and other weak-force-involving decays) produce isobars.

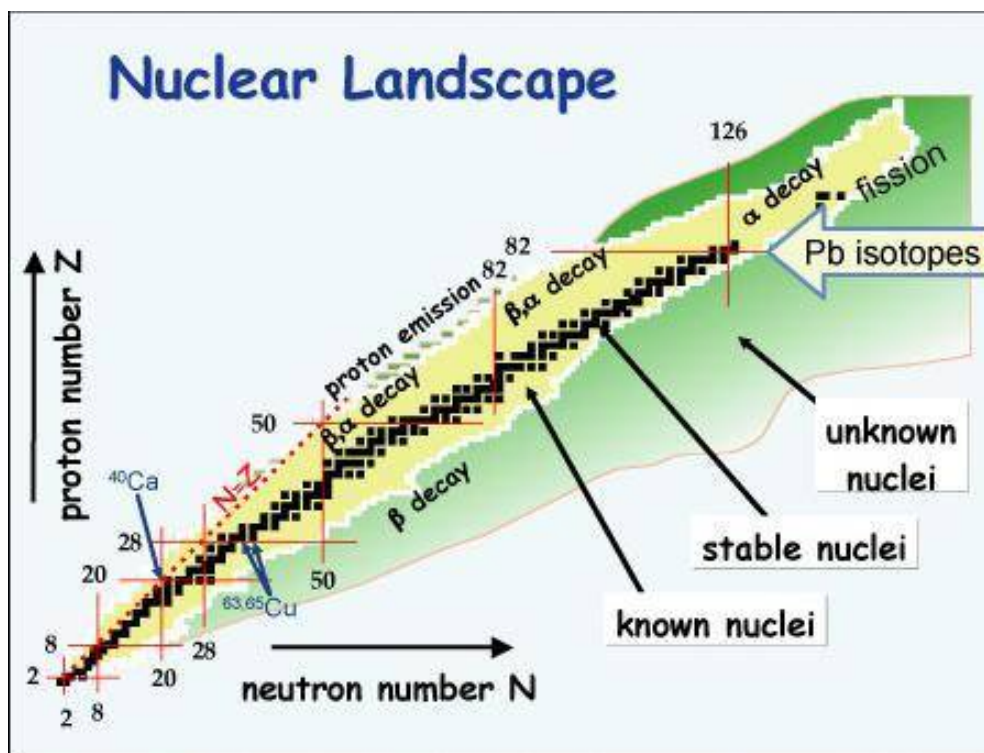

An example of positron emission ( $\beta^+$  decay) is shown with Magnesium 23 decaying into Sodium 23

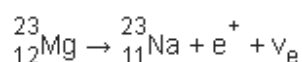

Gravitation by Prof. Subhashish Chattopadhyay SKMClasses Bangalore Useful for IIT-JEE, CBSE, I.Sc. PU-II, Boards, CET, CEE, PET, IGCSE IB AP-Physics and other exams

Gravitation by Prof. Subhashish Chattopadhyay SKMClasses Bangalore Useful for IIT-JEE, CBSE, I.Sc. PU-II, Boards, CET, CEE, PET, IGCSE IB AP-Physics and other exams

With a positron emission a Proton changes to Neutron. So Mass number remains the same. In 1934 Frederic and Irene Joliot Curie bombarded aluminium with alpha particles to effect the

nuclear reaction  ${}^4_2\text{He} + {}^{27}_{13}\text{Al} \rightarrow {}^{30}_{15}\text{P} + {}^1_0\text{n}$ , and observed that the product isotope  ${}^{30}_{15}\text{P}$  emits a positron identical to those found in cosmic rays by Carl David Anderson in 1932. Meaning it is surely not so new or modern phenomena that " Modern Physics " chapter of Modern Books are not covering this ! 3 year back a IIT JEE question with Positron is also not changing the taboo !

Once again I will say " So strange is this World ! "

Modern Physics 6 ) Relativistic correction for mass when electrons are flying at very high speed due to very high voltage.

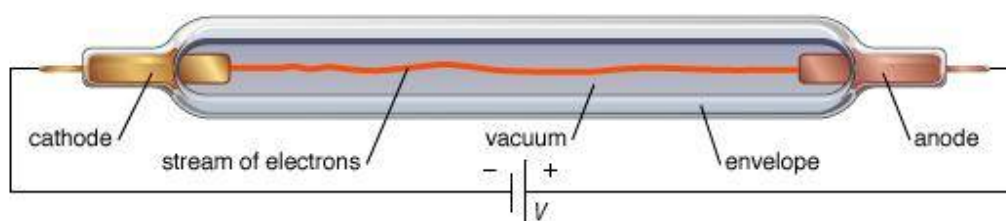

If the voltage is 10KV then what will be the speed of the electrons ?

We know Charge X Voltage = Energy =  $\frac{1}{2} mv^2$

Well so far so good. Substitute the values ....

Charge of electron  $e = 1.6 \times 10^{-19}$  Coulomb and mass of electron  $m = 9.1 \times 10^{-31}$  kg or 0.511 MeV For sake of this discussion let us approximate electron mass as 0.5 MeV/ $c^2$

So  $e ( 10^4 )V = 10^4 \text{ eV} = \frac{1}{2} mv^2 = ( \frac{1}{2} )( \frac{1}{2} \text{ MeV} )(v/c)^2 = ( \text{MeV}/4 ) (v/c)^2$

$4 \times 10^4 = 10^6 (v/c)^2 \Rightarrow 4/100 = (v/c)^2 \Rightarrow v/c = 1/5 \Rightarrow v = c/5$

Upto speed of around  $c/5$  we do not take relativistic corrections.

Now what would be the speed of the electrons if the voltage was 1MV ?

A wrong calculation and thus wrong answer would be

X  $e ( 10^6 ) V = \frac{1}{2} mv^2 = ( \frac{1}{2} )( \frac{1}{2} \text{ MeV} )(v/c)^2 = ( \text{MeV}/4 ) (v/c)^2$

X  $4 = (v/c)^2$

X  $v/c = 2 \Rightarrow v = 2c$

Students should know that particles can't move at speed more than  $c$

Gravitation by Prof. Subhashish Chattopadhyay SKMClasses Bangalore Useful for IIT-JEE, CBSE, I.Sc. PU-II, Boards, CET, CEE, PET, IGCSE IB AP-Physics and other exams



**An 1 mark question in Karnataka CET had an option close to 98% of c. Student can guess this and tick.** While the calculation will be as follows

$$\text{Let } k = \sqrt{1 - \frac{v^2}{c^2}}$$

$$\text{We will have } e (10^6) V = \frac{1}{2} (m/k)v^2 = \left(\frac{1}{2}\right) \left(\frac{1}{2} \text{ MeV}/k\right) (v/c)^2 = (\text{MeV}/4k) (v/c)^2$$

$$\text{So } 4k = (v/c)^2 \quad \text{put } v/c = x \quad \text{we get } 4\sqrt{1 - x^2} = x^2 \quad \text{put } x^2 = y \quad \text{so } 4\sqrt{1 - y} = y$$

$$\text{Or } 16(1 - y) = y^2 \Rightarrow y^2 + 16y - 16 = 0 \quad \text{Solve the quadratic to get } y = 0.95$$

$$\text{So } x^2 = 0.95 \text{ or } x = \sqrt{0.95} = 0.975 \Rightarrow v/c = 0.975 \text{ or } v = 97.5\% \text{ of light speed}$$

Electronics 1)

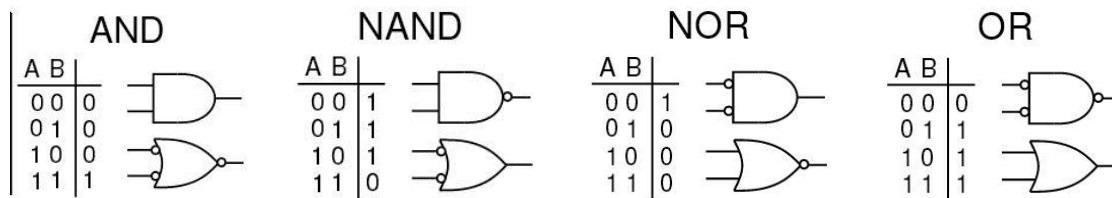

The small circle (bubble) at the output of the graphic symbol of a NOT gate is formally called a negation indicator and designates the logical complement.

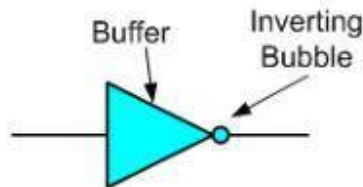

**NOT gate can be implemented by NOR Gate. All the pins have to be connected to same signal.**

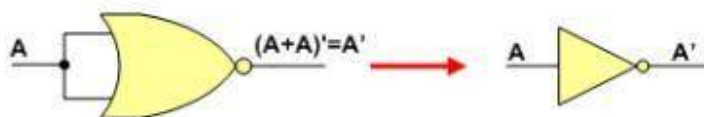

**Similarly NOT gate can be implemented with NAND gates**

All NAND input pins connect to the input signal **A** gives an output **A'**.

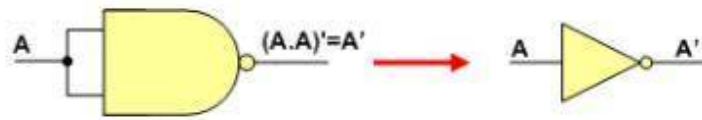

XOR ( exclusive OR ) gate can be implemented with other gates. In various exams the connections are asked.

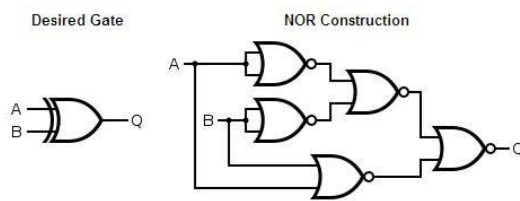

Truth Table

Input A	Input B	Output Q
0	0	0
0	1	1
1	0	1
1	1	0

Exclusive-OR equivalent circuit

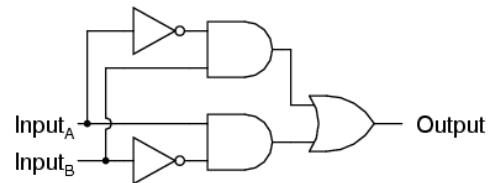

A	B	Output
0	0	0
0	1	1
1	0	1
1	1	0

Exclusive OR (XOR)

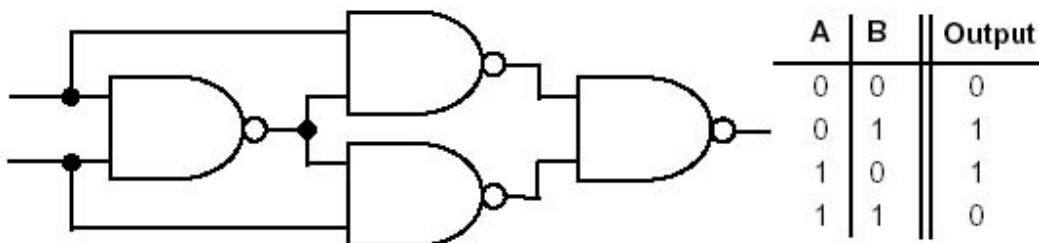

A	B	Output
0	0	0
0	1	1
1	0	1
1	1	0

To design the logic circuits the following laws of Boolean algebra are commonly used: commutativity, associativity, distributivity, and De Morgan's laws. Note that distributivity of disjunction over conjunction and both De Morgan's laws do not have their counterparts in ordinary algebra of real numbers.

Property	For conjunction	For disjunction
Commutativity	$A \cdot B = B \cdot A$	$A + B = B + A$
Associativity	$A \cdot (B \cdot C) = (A \cdot B) \cdot C$	$A + (B + C) = (A + B) + C$
Distributivity	$A \cdot (B + C) = A \cdot B + A \cdot C$	$A + B \cdot C = (A + B) \cdot (A + C)$
De Morgan's laws	$\overline{A \cdot B \cdot \dots} = \overline{A} + \overline{B} + \dots$	$\overline{A + B + \dots} = \overline{A} \cdot \overline{B} \cdot \dots$
Basic identities	$A \cdot 0 = 0$ $A \cdot 1 = A$ $A \cdot A = A$ $A \cdot \overline{A} = 0$	$A + 1 = 1$ $A + 0 = A$ $A + \overline{A} = 1$
Additional identities	$A \cdot (\overline{A} + B) = A \cdot B$ $A + \overline{A} \cdot B = A + B$ $(A + B) \cdot (\overline{A} + \overline{B}) = \overline{A \cdot B}$	$A + A \cdot B = A + B$ $A \cdot (\overline{A} + B) = A \cdot B$ $A \cdot B + \overline{A} \cdot B = B$

Principal identities and laws of Boolean algebra.

### Implementing OR Gate with NAND gates

An OR gate can be replaced by NAND gates as shown in the figure (The OR gate is replaced by a NAND gate with all its inputs complemented by NAND gate inverters).

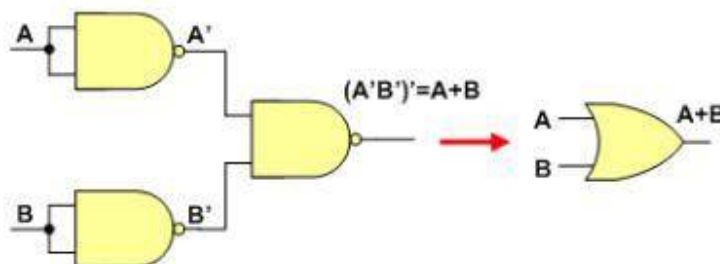

### Implementing AND gate with NOR gates

An AND gate can be replaced by NOR gates as shown in the figure (The AND gate is replaced by a NOR gate with all its inputs complemented by NOR gate inverters).

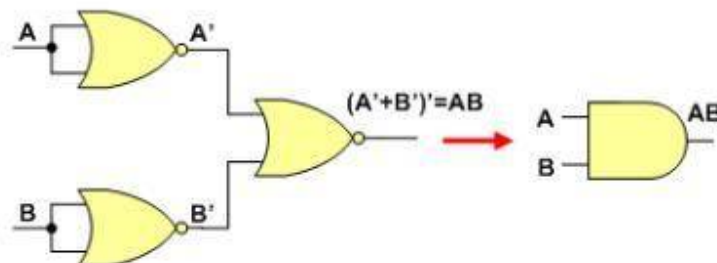

### Colour Code for Carbon Resistors

Since a carbon resistor is physically quite small, it is more convenient to use a *colour code* indicating the resistance value than to imprint the numerical value on the case. In this scheme, there are generally four colour bands *A*, *B*, *C* and *D* printed on the body of the resistor as shown in Fig. The first three colour bands (*A*, *B* and *C*) give the value of the resistance while the fourth



band (*D*) tells about the \*tolerance in percentage. The table below shows the colour code for resistance values and colour code for tolerance.

#### Colour Code for Resistance Values

Black	0	Green	5
Brown	1	Blue	6
Red	2	Violet	7
Orange	3	Grey	8
Yellow	4	White	9

#### Colour Code for Tolerance

Gold	$\pm 5\%$
Silver	$\pm 10\%$
No colour	$\pm 20\%$

- (i) To read the resistance value, we refer to the first three colour bands (*A*, *B* and *C*). The first two colour bands (*A*, *B*) specify the first two digits of the resistance value and the third colour band (*C*) gives the number of zeros that follow the first two digits. Suppose the first three colour bands (*A*, *B*, *C*) on the resistor are red, brown, orange respectively. Then value of the resistance is 21,000  $\Omega$ .

Red : 2

Brown : 1

Orange : 000

$\therefore$  Value = 21,000  $\Omega$

(ii) The fourth band *D* gives the value of tolerance in percentage. If colour of the fourth band is gold, tolerance is  $\pm 5$  per cent and if silver, then tolerance is  $\pm 10$  per cent. If the fourth band is omitted, the tolerance is assumed to be  $\pm 20$  per cent.

0 B ↓ Black	1 B ↓ Brown	2 R ↓ Red	3 O ↓ Orange	4 Y ↓ Yellow	5 G ↓ Green	6 B ↓ Blue	7 V ↓ Violet	8 G ↓ Grey	9 W ↓ White
----------------------	----------------------	--------------------	-----------------------	-----------------------	----------------------	---------------------	-----------------------	---------------------	----------------------

**Note.** In order to remember the colour code, the above sentence may be helpful.

**Example** The colour coded carbon resistors are shown in Fig. Find their resistance values.

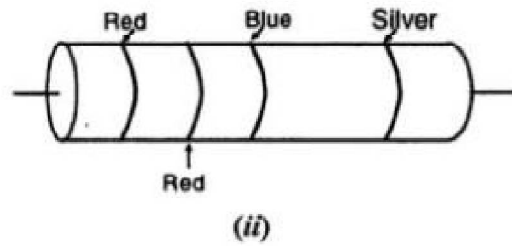
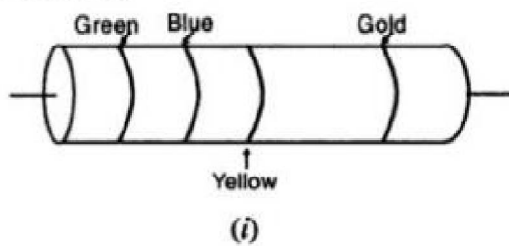

**Solution.** The first colour represents the digit 5. The second colour represents the digit 6. The third colour represents the digit 4, *i.e.*, four zeros. Therefore, the value of the resistance is  $56,0000 \Omega$ . The fourth gold strip indicates  $\pm 5\%$  tolerance. Hence, resistance specification of the resistor is

$$560000 \Omega ; \pm 5\%$$

(ii) Refer to Fig. resistor is

Following above procedure, the resistance specification of this

$$22,000000 \Omega ; \pm 10\%$$

- \* Due to manufacturing variations, the resistance value may not be the same as indicated by colour code. Thus, a resistor marked  $100 \Omega, \pm 10\%$  tolerance means that resistance value is between  $90 \Omega$  and  $110 \Omega$ .

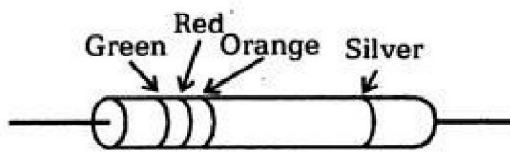

"Carbon resistor colour code"

The value of the above resistor as shown in the fig. is

The first ring Green	-	5
The second ring Red	-	2
The third ring Orange ring corresponds to	-	$10^3$

The silver ring represents 10% tolerance

∴ Total resistance is

$$52 \times 10^3 \pm 10\% \text{ (or) } 52\text{k}\Omega, 10\%$$

Varactor diode

$\text{—} \triangleright \text{—}$  is the symbol of

- (a) a capacitor                      (b) photo diode  
(c) varactor diode                  (d) tunnel diode

**Ans: (c)**

### Common emitter

**In a common emitter configuration the base-emitter voltage is  $3 \times 10^{-2}$  V. If the base current is  $30 \mu\text{A}$ , the input impedance is**

- (a)  $1 \text{ k}\Omega$                       (b)  $3 \text{ k}\Omega$   
(c)  $100 \Omega$                       (d)  $2 \text{ k}\Omega$

**Ans: (a)**

**Solution:**

**Given data:-**

$$(V_{BE}) = \text{Base emitter voltage} = 3 \times 10^{-2} \text{V}$$

$$\text{Base current } (I_B) = 30 \times 10^{-6} \text{ A}$$

$$\text{Input impedance } Z_i = \left( \frac{\Delta V_{BE}}{\Delta I_B} \right)_{V_{CE}}$$

$$Z_i = \frac{3 \times 10^{-2}}{30 \times 10^{-6}}$$

$$Z_i = Z_i = \frac{3 \times 10^{-2}}{10 \times 10^{-6}} = 10^{-2-1+6}$$

$$Z_i = 10^3 \Omega$$

$$Z_i = 1 \text{ k}\Omega$$

### Common base

**In a common base configuration, the collector current is  $0.95 \text{ mA}$  and base current is  $0.05 \text{ mA}$ , then the value of current gain is**

- (a)  $0.89$                       (b)  $0.9$   
(c)  $0.95$                       (d)  $0.99$

**Ans: (c)**

**Given data:-**

$$\text{Collector current } I_C = 0.95 \times 10^{-3} \text{ A}$$

$$\text{Base current } I_B = 0.05 \text{ mA} = 0.05 \times 10^{-3} \text{ A}$$

**Solution:**

$$\text{Current gain } \alpha = \left( \frac{I_C}{I_E} \right)$$

$$I_E = \text{Emitter current} = I_C + I_B$$

$$= (0.95 + 0.05) \times 10^{-3} \text{ A}$$

$$= 1 \times 10^{-3} \text{ A} = 1 \text{ mA}$$

$$\alpha = \frac{0.95 \times 10^{-3} \text{ A}}{1 \times 10^{-3} \text{ A}} = 0.95$$

**The current gain is 0.95**

### Common emitter

**In a common emitter amplifier, the output resistance is  $5000 \Omega$  and the input resistance is  $2000 \Omega$ . If the peak value of the signal voltage is  $10 \text{ mV}$  and  $\beta = 50$ , then the peak value of the output voltage is**

- (a)  $5 \times 10^{-6} \text{ V}$                       (b)  $1.25 \text{ V}$   
(c)  $125 \text{ V}$                                 (d)  $2.5 \times 10^{-4} \text{ V}$

**Ans: (b)**

**Given data:-**

$$R_L = 5000 \Omega$$

$$R_i = 2000 \Omega$$

$$\beta = 50$$

**Solution:**

The ac voltage gain is given by

$$\beta \times \frac{R_L}{R_i} = \frac{50 \times 5000}{2000} = 125$$

$$\begin{aligned} \therefore \text{peak output voltage} &= \text{voltage gain} \times \text{signal voltage} \\ &= 125 \times 10 \text{ mV} = 1250 \text{ mV} = 1.25 \text{ V} \end{aligned}$$

### Common base

**In a common base amplifier circuit, calculate the change in base current if that in the collector current is  $2 \text{ mA}$  and  $\alpha = 0.98$**

- (a)  $0.04 \text{ mA}$                               (b)  $1.96 \text{ mA}$   
(c)  $980 \text{ mA}$                                 (d)  $2 \text{ mA}$

**Ans: (a)**

**Solution:**

$$\beta = \frac{\alpha}{1 - \alpha} = \frac{0.98}{1 - 0.98} = 49$$

$$\text{Now } \Delta I_c / \Delta I_b = 49$$

$$\text{or } \Delta I_b = \Delta I_c / 49$$

$$\begin{aligned} \therefore \Delta I_b &= 2 \text{ mA} / 49 \\ &= 0.04 \text{ mA} \end{aligned}$$



### Common base

**In a common base circuit of a transistor, current amplification factor is 0.95. Calculate the base current when emitter current is 2 mA.**

- (a) 0.1 mA                      (b) 1 mA  
(c) 0.01 mA                    (d) none of these

**Ans: (a)**

**Solution:**

$$\alpha = \frac{I_C}{I_E}$$

$$0.95 = \frac{I_C}{2 \times 10^{-3}}$$

$$I_C = 1.90 \times 10^{-3} \text{ A} = 1.9 \text{ mA}$$

$$\text{Now } I_B = I_E - I_C = 0.1 \text{ mA}$$

### Common emitter

**A transistor is connected in common emitter (CE) configuration. The collector supply is 8V and the voltage drop across a resistor of  $800\Omega$  in the collector circuit is 0.5V. If the current gain factor ( $\alpha$ ) is 0.96. Find the base current.**

- (a) 20  $\mu\text{A}$                       (b) 26  $\mu\text{A}$   
(c) 30  $\mu\text{A}$                       (d) none of these

**Ans: (b)**

**Solution:**

$$\text{Collector current } I_C = \frac{0.5}{800} \text{ A}$$

$$\text{Current gain } \beta = \frac{I_C}{I_B}$$

$$\frac{\alpha}{1 - \alpha} = \frac{0.96}{800} \text{ A}$$

$$I_B = \frac{I_C}{24} = \frac{0.5}{800 \times 24} \\ = 26 \mu\text{A}$$

### Conductivity

Conductivity is defined as the current density per unit applied electric field. If  $J$  is the current density due to an applied electric field  $E$ , then the conductivity ( $\sigma$ ) is given by,

$$\sigma = \frac{J}{E} \quad \text{.....(1)}$$

In S.I.,  $\sigma$  is given in Siemens/meter or mho/meter as 1 siemen = 1 mho

For a cylindrical semiconductor, the current density is given by,

$$J = nev \quad \text{.....(2)}$$

where  $n$  is the number of charge carriers in the semiconductor  $e$  is the electronic charge and  $v$  is the drift velocity of the electron.

Also, we have  $v = \mu E$  .....(3)

where  $\mu$  is the mobility of the charge carrier and  $E$  is the applied electric field.

Then, equation (2) can be written,

$$J = ne\mu E$$

then, equation (1) becomes,

$$\sigma = ne\mu \quad \text{.....(4)}$$

Now, if the conductivity of a semiconductor is due to electron then it is denoted by  $\sigma_n$ , and equation (4), can be written as

$$\sigma_n = ne\mu_n \quad \text{.....(5)}$$

where  $n$  is the number of electron and  $\mu_n$  is the mobility of electron.

Similarly, the conductivity of a semiconductor due to the holes is given by,

$$\sigma_p = pe\mu_p \quad \text{.....(6)}$$

where  $p$  is the hole concentration and  $\mu_p$  is the hole mobility.

Hence, the overall conductivity of the semiconductor containing electrons and holes is given by,

$$\sigma = \sigma_n + \sigma_p = e(n\mu_n + p\mu_p) \quad \text{.....(7)}$$

For an intrinsic semiconductor,  $n = p = n_i$

Therefore, the conductivity of an intrinsic semiconductor,

$$\sigma_{int} = n_i e(\mu_n + \mu_p) \quad \text{.....(8)}$$

For an  $n$ -type semiconductor,  $n \gg p$ , then

$$\sigma_n \approx ne\mu_n \quad \text{.....(9)}$$

Similarly, for a  $p$ -type semiconductor

$$\sigma_p = pe\mu_p \quad \text{.....(10)}$$

These equations shows that conductivity  $\sigma$  has the same temperature dependence as  $\mu_e$  or  $\mu_n$ .

Mobility is a more useful property for characterizing a semiconductor than conductivity. Conductivity,  $\sigma$  depends on carrier concentration *i.e.*, on doping level but mobility  $\mu$  does not depend. Thus, mobility is the property of semiconductor itself.

**Problem 1 :** At 300 K, the intrinsic carrier concentration of silicon is  $1.5 \times 10^{16} \text{ m}^{-3}$ . If the electron and the hole mobilities are 0.13 and 0.05  $\text{m}^2/\text{sec-V}$  respectively. Determine the conductivity and resistivity of silicon.

**Solution :** The electrical conductivity of intrinsic semiconductor is given by,

$$\sigma_i = n_i e (\mu_n + \mu_p)$$

Here,  $n_i = 1.5 \times 10^{16} \text{ m}^{-3}$ ,  $\mu_n = 0.13 \text{ m}^2/\text{sec-V}$ ,  $\mu_p = 0.05 \text{ m}^2/\text{sec-V}$  and  $e = 1.6 \times 10^{-19} \text{ Coulomb}$

$$\begin{aligned} \therefore \sigma_i &= 1.5 \times 10^{16} \times 1.6 \times 10^{-19} \times (0.13 + 0.05) \\ &= 2.4 \times 10^{-3} \times 0.18 = 0.432 \times 10^{-3} \\ &= 4.32 \times 10^{-4} \text{ mho/m} \end{aligned}$$

Hence, the resistivity  $\rho_i$  is given by

$$\rho_i = \frac{1}{\sigma_i} = \frac{1}{4.32 \times 10^{-4}} = 2.31 \times 10^3 \text{ ohm-m}$$

**Problem 2 :** The resistivity of pure silicon at room temperature is 3000 ohm-m. Calculate the intrinsic carrier concentration. Given that :  $\mu_n = 0.14 \text{ m}^2/\text{sec-V}$  and  $\mu_p = 0.05 \text{ m}^2/\text{sec-V}$ .

**Solution :** In pure silicon, electrons and holes (the intrinsic charge carriers) are equal in numbers. The conductivity of pure semiconductor is given by

$$\sigma = n_i e (\mu_n + \mu_p) \quad \text{or} \quad n_i = \frac{\sigma}{e(\mu_n + \mu_p)} = \frac{1}{\rho e (\mu_n + \mu_p)} \quad \left[ \because \rho = \frac{1}{\sigma} \right]$$

$$\therefore n_i = \frac{1}{(0.14 + 0.05) \times 3000 \times 1.602 \times 10^{-19}} = 1.095 \times 10^{16} \text{ m}^{-3}$$

**The band gap of a specimen of gallium arsenide phosphide is 1.98 eV. Determine the wavelength of the radiation that is emitted when electron jumps from conduction band to the valence band to recombine with a hole.**

**Solution :** The wavelength of emitted radiation is given by,

$$\lambda = \frac{hc}{E_g}$$

Here,  $h$  = Planck's constant =  $6.62 \times 10^{-34} \text{ J.s}$ ,  $c$  = velocity of light =  $3 \times 10^8 \text{ m/s}$  and

$$E_g = \text{Energy band gap} = 1.98 \text{ eV} = 1.98 \times 1.6 \times 10^{-19} \text{ J.}$$

$$\begin{aligned} \therefore \lambda &= \frac{6.62 \times 10^{-34} \times 3 \times 10^8}{1.98 \times 1.6 \times 10^{-19}} = 6.269 \times 10^{-7} \text{ m} \\ &= 6269 \text{ \AA} \end{aligned}$$

Since this wave-length is in the visible range, so the colour of the emitted radiation will be red.

**Q. An  $n$ -type semiconductor crystal has more free electrons than holes. Is it then negatively charged ?**

**Ans :** An  $n$ -type semiconductor has free electrons as charge carriers. These are donated by pentavalent impurity atoms which becomes positively charged. Although there are some thermally generated electron-hole pairs, but the number of these holes is negligibly small in comparison to the total number of electrons. Thus,  $n$ -type semiconductor mainly consists of negatively charged free electrons and nearly equal number of positively charged donor ions. Hence, the material as a whole is electrically neutral.

**Q. *p*-type semiconductor crystal has more holes than electrons. Is it then positively charged ?**

**Ans :** A *p*-type semiconductor has holes as charge carriers. These holes are due to trivalent impurity atoms which become negatively charged by accepting the electrons from the neighbouring Ge atom. Although there are some thermally generated electron-hole pairs, but the number of these electrons is negligibly small in comparison to the total number of holes. Thus, *p*-type semiconductor mainly consists of positively charged holes and nearly equal number of negatively charged acceptor ions. Hence, the material as a whole is electrically neutral.

**Q. Why does the width of depletion region increase when a *p-n* junction is reverse biased ?**

**Ans :** In reverse bias, negative terminal of the battery is connected to *p*-side and positive terminal to *n*-side of *p-n* junction. So, the electrons are attracted towards positive terminal and holes towards negative terminal of the battery. Thus, holes and free electrons move away from the junction. Therefore, the depletion layer gets wider. The width of the layer increases with increasing reverse voltage.

**Q. The small current flowing through a reverse biased junction diode is called the reverse saturation current, why ?**

**Ans :** The reverse current is due to the thermally generated minority carriers. We cannot increase the number of these minority carriers by applying and increasing the reverse voltage. So, it is termed as saturation current. This current flows in the opposite direction with respect to forward bias, so it is called reverse. Due to above both factors it is called reverse saturation current.

**Q. The reverse saturation current of a Si diode is much smaller than a Ge diode of the same size, why ?**

**Ans :** The barrier potential of Si is 0.7 eV while that of Ge is 0.3 V. Hence, less number of thermally generated minority carriers cross the junction in Si diode than that in Ge diode of the same size. Therefore, the reverse current in Si diode is smaller than the Ge diode at the same temperature and for the same size.

**Q. Differentiate between Avalanche and Zener breakdown.**

**Ans :** **Avalanche breakdown :** For a simple *p-n* junction, if we apply a reverse bias to the junction, a very small current due to minority carriers flows through the junction. On increasing the reverse voltage the minority carriers (electrons) may attain sufficient kinetic energy to knock out valency electron from the covalent bonds. As a result more electron-hole pairs are generated. Due to the high reverse bias voltage, these new carriers are also accelerated and collide with other covalent bonds. This process will continue until an avalanche of electrons is formed and a very large current flows through the junction diode. This breakdown is known as Avalanche breakdown. This breakdown occurs at very high voltage.

**Zener breakdown :** If the *p-n* junction is heavily doped then the electric field across the depletion layer becomes large enough. When we apply a reverse bias to this junction then this electric field becomes so large even at low voltage that it may cause rupture of the covalent bonds and breakdown the junction. This breakdown is known as Zener breakdown and this diode is known as Zener diode. This breakdown occurs at lower voltage than avalanche breakdown.

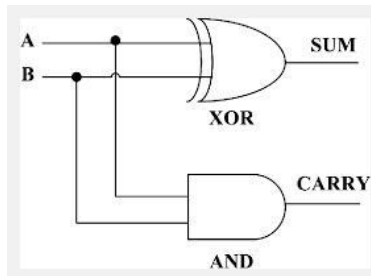

Half Adder

**Q. : What is mass-action law for the carrier concentrations in a semiconductor ? What is its significance ?**

**Ans :** The law of mass-action states that in any type of semiconductor ( $p$  or  $n$  type), the product of free electrons concentration,  $n$  and hole concentration,  $p$  is a constant and equal to  $n_i^2$  where  $n_i$  is the intrinsic carrier concentration *i.e.*,

$$np = n_i^2$$

The intrinsic carrier concentration  $n_i$  is a function of temperature. At a given temperature if electron concentration is increased by doping, the corresponding hole concentration ( $p$ ) must decrease (or vice-versa) to keep  $np$  a constant ( $= n_i^2$ ) at a particular temperature.

**Q. : Explain why an extrinsic semiconductor at high temperature behaves like an intrinsic one.**

**Ans :** At very high temperature, the concentration of thermally generated free electrons from the valence band becomes much larger than concentration of free electrons contributed by donors (as donor atoms are already ionized). In this condition, the hole and electron concentrations will be nearly equal and semiconductor will behave like an intrinsic one. Due to the same reason  $p$ -type semiconductor will also behave like an intrinsic semiconductor at very temperatures. So, we can say that an extrinsic semiconductor changes to an intrinsic one at very high temperatures.

**Q. : What do you mean by the term "doping" and "dopant" . Name some dopant materials ?**

**Ans :** The addition of a small percentage of impurity atoms to a semiconductor is called "doping" and the impurity, which is added, is referred to as "dopant". In Ge or Si, the elements of V group like phosphorous (P) antimony (Sb) and arsenic (As) and the elements of III group like aluminium (Al), Indium (In) boron (B) and gallium (Ga) are dopant.

**Q. Write diode equation and with the help of this equation describe the volt-ampere characteristics of the diode.**

**Ans :** The diode equation is written as,

$$I = I_0 (\exp \frac{eV}{kT} - 1) \quad \dots\dots(1)$$

where  $I$  is current at applied voltage,  $V$

$I_0$  is constant and known as reverse saturation current  
 $e$  is electronic charge  
 $k$  is Boltzmann constant  
 and  $T$  is absolute temperature  
 With the help of this equation we can describe the volt ampere characteristics as shown in fig 1.23

If  $V$  is positive *i.e.*, for a forward bias

then,  $\exp \frac{eV}{kT} \gg 1$

So, equation (1) can be written as,

$$I = I_0 \exp \frac{eV}{kT}$$

Hence, for a forward bias, current increases exponentially as shown in fig. 1.24.

Similarly, if  $V$  is negative *i.e.*, for a reverse bias then,

$$\exp^{-\frac{eV}{kT}} \ll 1$$

So, equation (1) can be written as,

$$I = -I_0$$

Hence, for a reverse bias current is constant in reverse direction as shown in fig.

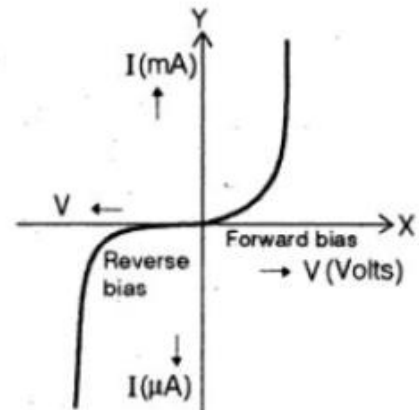

**Q.** How reverse current depends upon the temperature of the junction ?

**Ans :** The reverse current in a  $p-n$  junction diode depends on the temperature  $T$ . The rise in temperature increases the generation of electron hole pairs in semiconductors and increases their conductivity as a result the current through junction diode increases with temperature. For practical diodes it is found that reverse saturation current  $I_0$  will just about double in magnitude for every  $10^\circ\text{C}$  increase in temperature. Typical values of  $I_0$  for silicon are much lower than that of Germanium for similar power and current levels. The result is that silicon junction diodes are more preferred than Ge for rectifiers and have higher breakdown voltage.

**Q. :** What do you mean by tunnel diode ?

**Ans :** Tunnel diode is very high doped ( $\approx 10^{25}/\text{m}^3$ )  $p-n$  junction in both  $p$  and  $n$  region. Since, the depletion layer of this diode becomes very thin, so, on applying forward bias many carriers can tunnel through the depletion layer and the process is known as tunnelling. Hence, the diode is known as tunnel diode.

Gravitation by Prof. Subhashish Chattopadhyay SKMClasses Bangalore Useful for IIT-JEE, CBSE, I.Sc. PU-II, Boards, CET, CEE, PET, IGCSE IB AP-Physics and other exams

Heat or Thermodynamics 1 ) So many exams including IIT JEE had questions on Polytrropic processes. Apart from Professor N. N. Ghosh's books, hardly this is covered in Physics Books

I am surprised and **amused** to see so many coaching Institutes making errors in Polytrropic Process Problems. In most cases the teachers are avoiding it, and in rare cases when it is being covered there are errors.

Let us do it here.

We assume ideal gas for Thermodynamics process problems. So  $PV = nRT$  is taken as true regardless the process gas is taken through. So Isothermal ( meaning constant Temperature ), Isobaric ( meaning const Pressure ), Isochoric ( meaning constant Volume ) or even  $PV^z = \text{Const}$  ( P into V to the power z is constant ) where z is a constant of the polytrropic process, the expression  $PV = nRT$  is taken as true. We do substitute that to exchange the variables in many problems.

Work done by system on boundary is:

$$W = \int_{V_1}^{V_2} p \, dV$$

P | ~~can be a polytrropic exp~~

This form is used for expansion and contraction of gases  
Ideal Gases

### **Ideal (Perfect) Gas Law**

$$pV = nRT$$

$$R = 8314 \frac{\text{kJ}}{\text{kmol} \cdot \text{K}}$$

If the gas expands ( often due to supply of heat ) the work done by the gas is taken as positive.

Work done expression in Isothermal ( or isotropic as some people say it ) is given by

### **Isothermal (Constant Temp) Process or Isothermal process**

- For a constant temperature process in a closed system (i.e. mass is constant) –  $pV = mRT = C$ . Where C is a constant. Note C can be written as  $p_1V_1$  or as  $p_2V_2$ .

$$W = \int_{V_1}^{V_2} \frac{C}{V} \, dV = C \ln\left(\frac{V_2}{V_1}\right) = p_1V_1 \ln\left(\frac{V_2}{V_1}\right) = nRT \ln\left(\frac{V_f}{V_i}\right) = nRT \ln\left(\frac{P_i}{P_f}\right)$$

Gravitation by Prof. Subhashish Chattopadhyay SKMClasses Bangalore Useful for IIT-JEE, CBSE, I.Sc. PU-II, Boards, CET, CEE, PET, IGCSE IB AP-Physics and other exams

**Polytropic process -  $pV^n=C$  where C is a constant.**

these occur in ideal gases for various processes and the value of  $n$  changes depending on the type of process (e.g.  $n = 1$  is a isotropic process).

Note that  $p_1V_1^n=C \rightarrow p_1V_1=\frac{CV_1}{V_1^n}=CV_1^{1-n}$  This also holds for  $p_2V_2$ .

$$W = \int_{V_1}^{V_2} \frac{C}{V^n} dV = \frac{C}{1-n} (V_2^{1-n} - V_1^{1-n}) = \frac{p_2V_2 - p_1V_1}{1-n}$$

In case of adiabatic process ( where no heat exchange takes place ),  $n$  is  $\gamma$  ( gamma ), so in the above expression replace  $n$  as  $\gamma$

$$pV^\gamma = p_1V_1^\gamma = p_2V_2^\gamma = k$$

Thus, 
$$p = \frac{k}{V^\gamma}$$

The work done by the gas in the process is

$$W = \int_{V_1}^{V_2} p dV = \int_{V_1}^{V_2} \frac{k}{V^\gamma} dV = \frac{1}{1-\gamma} \left[ \frac{k}{V_2^{\gamma-1}} - \frac{k}{V_1^{\gamma-1}} \right]$$

From equation (i),

$$\frac{k}{V_2^\gamma} = p_2 \text{ and } \frac{k}{V_1^\gamma} = p_1$$

Thus, 
$$W = -\frac{1}{\gamma-1} (p_2V_2 - p_1V_1) = \frac{p_1V_1 - p_2V_2}{\gamma-1}$$

There are other expressions which are handy ( given for 1 mole of gas ), for Heat supplied in Polytropic Process

$$\Delta H = C_P^0(T_2 - T_1) = \frac{\gamma R}{\gamma-1} (T_2 - T_1) = \frac{\gamma}{\gamma-1} (P_2V_2 - P_1V_1) = \frac{\gamma P_1V_1}{\gamma-1} \left[ \left( \frac{P_2}{P_1} \right)^{1-\frac{1}{n}} - 1 \right]$$

Heat Supplied in a process at constant Pressure is  $\Delta H = C_P^0(T_2 - T_1)$



Process	Work Done: (W)	Heat Exchanged ( $\Delta Q$ )
Isothermal process	$W = 2303 nRT \log_{10} \frac{V_2}{V_1}$	$\Delta Q = 2.30 nRT \log \frac{V_2}{V_1}$
Adiabatic process	$W = \frac{p_1 V_1 - p_2 V_2}{\gamma - 1}$ $= \frac{nR(T_2 - T_1)}{\gamma - 1}$	$\Delta Q = 0$
Isochoric process	$W = 0$	$\Delta Q = nC_v \Delta T$ (use definition of $C_v$ )
Isobaric process	$W = p\Delta V = p(V_2 - V_1)$ $W = nR(T_2 - T_1)$	$\Delta Q = nC_p \Delta T$ (use definition of $C_p$ )

VdP expression in polytropic process

For a polytropic process  $P_1 V_1^n = P V^n$

$$V = \left( \frac{P_1 V_1^n}{P} \right)^{\frac{1}{n}} = \left( \frac{P_1}{P} \right)^{\frac{1}{n}} V_1$$

$$\int V dP = P_1^{\frac{1}{n}} V_1 \int \frac{1}{P^{\frac{1}{n}}} dP$$

$$\int V dP = \frac{P_1^{\frac{1}{n}} V_1}{1 - \frac{1}{n}} \left( P_2^{1 - \frac{1}{n}} - P_1^{1 - \frac{1}{n}} \right)$$

$$\int V dP = \frac{n V_1}{n - 1} \left( P_1^{\frac{1}{n}} P_2^{1 - \frac{1}{n}} - P_1 \right)$$

$$P_1 \int_{P_1}^2 V dP = \frac{n P_1 V_1}{n - 1} \left[ \left( \frac{P_2}{P_1} \right)^{1 - \frac{1}{n}} - 1 \right]$$

$$- \int_1^2 V dP = \frac{n P_1 V_1}{n - 1} \left[ 1 - \left( \frac{P_2}{P_1} \right)^{1 - \frac{1}{n}} \right]$$

Specific heat in case of Polytropic process and  $C_v$  in terms of gamma

$$C = \frac{R}{\gamma-1} - \frac{R}{k-1}$$
$$C_v = \frac{R}{\gamma-1}$$

Example

One mole of Argon is heated using  $PV^{3/2} = \text{const}$ . Find the amount of heat obtained by the process when the temperature changes by  $\Delta T = -26$  K.

**Solution**

Let  $p$  be the number of moles here  $p = 1$

$$\text{then } C = \frac{R}{\gamma-1} - \frac{R}{\eta-1} = \frac{R}{\frac{5}{3}-1} - \frac{R}{\frac{3}{2}-1}$$

$$\Delta Q = pC\Delta T = 1 \left( \frac{3}{2}R - 2R \right) (-26)$$

$$= +26 \left( \frac{8.314}{2} \right) = 108 \text{ J}$$

You can also write  $+R / (1-k)$  in Specific heat expression so see an example

An ideal gas expands according to the law  $PV^{3/2} =$  constant. We conclude

- (a) The adiabatic exponent of the gas  $K = 1.5$
- (b) The molar heat capacity  $C = C_v - 2R$
- (c) Temperature increases during the process
- (d) Such a process is not feasible

Ans - (b) Molar heat capacity

$$C = C_v + \frac{R}{1-K} = C_v + \frac{R}{1-\frac{3}{2}} = C_v - 2R$$

IIT JEE 1995 Polytrropic Thermodynamics Process Problem

3 moles of a gas mixture having volume  $V$  and temperature  $T$  is compressed to 1/5th of the initial volume. Find the change in its adiabatic compressibility if the gas obeys  $PV^{19/13} = \text{constant}$  [ $R = 8.3 \text{ J/mol - K}$ ]

[IIT 1995]

$$\text{Bulk modulus } B = \gamma P$$

$$\text{Compressibility } C = \left( \frac{1}{B} \right) = \frac{1}{\gamma P}$$

and  $\Delta C = C - C$

or  $\Delta C = \frac{1}{\gamma} \left[ \frac{1}{P'} - \frac{1}{P} \right]$

$$PV^\gamma = P' \left( \frac{V}{5} \right)^\gamma$$

$$\text{With } \gamma = \frac{19}{13} \text{ and } P' = 5^{\gamma} P, 11$$

$$\Delta C = \frac{1}{\gamma P} \left[ \frac{1}{5^{\gamma}} - \frac{1}{1} \right] = \frac{13 \times 0.905}{19P}$$

$$\text{But } PV = nRT \text{ or } P = \frac{nRT}{V}$$

$$\Delta C = \frac{13(.905)V}{19 \times 3 \times 8.317T} = \frac{-0.0248V}{T}$$

An ideal gas with adiabatic exponent  $\gamma$ , is expanded according to the law

$$P = aV$$

where  $a$  is a constant. The initial volume of the gas is  $V_0$ . As a result volume increases  $\eta$  times. Find the increment in internal energy and work done.

**Solution -** Let  $k$  be number of moles

$$P = aV \text{ or } PV^{-1} = a$$

The process is polytropic with index  $n = -1$

$$\therefore V_{\text{initial}} = V_0, V_{\text{final}} = \eta V_0$$

$$\text{and } P_{\text{initial}} = aV_0; P_{\text{final}} = a\eta V_0$$

$$\Delta U = \frac{kR}{\gamma - 1} (T_{\text{final}} - T_{\text{initial}}), P_{\text{final}} V_{\text{final}} - P_{\text{initial}} V_{\text{initial}}$$

Work done,

$$W = \frac{P_{\text{initial}} V_{\text{initial}} - P_{\text{final}} V_{\text{final}}}{n - 1} = \frac{\alpha V_0^2 [\eta^2 - 1]}{2}$$

**In a polytropic process an ideal gas ( $\gamma = 1.40$ ) was compressed from volume  $V_1 = 10$  litres to  $V_2 = 5$  litres. The pressure increased from  $p_1 = 10^5$  Pa to  $p_2 = 5 \times 10^5$  Pa. Determine: (a) the polytropic exponent  $n$ , (b) the molar heat capacity of the gas for the process.**

**Solution.**

In a polytropic process  $pV^n = k$  (a constant)

$$\therefore p_1 V_1^n = p_2 V_2^n \quad \text{or} \quad \left(\frac{V_1}{V_2}\right)^n = \frac{p_2}{p_1}$$

$$\text{or} \quad n = \frac{\ln p_2/p_1}{\ln V_1/V_2}$$

$$\text{Here} \quad n = \frac{\ln 5}{\ln 2} = \frac{1.6094}{0.6931} = 2.32$$

In a polytropic process

$$C = \frac{R}{\gamma - 1} - \frac{R}{n - 1} = \frac{R}{1.4 - 1} - \frac{R}{2.32 - 1} = 1.74 R$$

**An ideal gas expands according to the law  $pV^2 = \text{constant}$  (a) Is it heated or cooled? (b) What is the molar heat capacity in this process?**

**Solution.**

This is a polytropic process of exponent  $n = 2$ . To find whether it is heated or cooled we have to examine whether  $\Delta Q$  is +ve or -ve or whether  $T$  increases or decreases.

$$pV^2 = \text{constant.} \quad \text{But } pV = RT \quad (\text{always})$$

$$\therefore \frac{pV^2}{pV} = \frac{\text{constant}}{RT} \quad \text{or} \quad V \propto \frac{1}{T}$$

Thus when volume increases  $T$  decreases. Here the gas is cooled.

$$(b) \quad C = \frac{R}{\gamma - 1} - \frac{R}{n - 1} = C_V - R$$

Gravitation by Prof. Subhashish Chattopadhyay SKMClasses Bangalore Useful for IIT-JEE, CBSE, I.Sc. PU-II, Boards, CET, CEE, PET, IGCSE IB AP-Physics and other exams

Heat or Thermodynamics 2 ) Formula for equivalent gamma in mixture of gases.  $n_1$  moles of gas with  $\gamma_1$  and  $n_2$  mole of gas with  $\gamma_2$  are mixed, then what is equivalent gamma ?

Why  $C_v = R / (\gamma - 1)$

Specific heat of a polytropic process. Derivation of work done in polytropic process.

$$\frac{n_1 + n_2}{\gamma - 1} = \frac{n_1}{\gamma_1 - 1} + \frac{n_2}{\gamma_2 - 1}$$

Equivalent  $\gamma$  of a mixture of gas.  
 $n_1$  moles of  $\gamma_1$  and  $n_2$  moles of  $\gamma_2$  are mixed

$$C_v = \frac{R}{\gamma - 1}$$

We have  $\gamma = \frac{C_p}{C_v} = \frac{C_v + R}{C_v}$

$$= 1 + \frac{R}{C_v}$$

$$\Rightarrow \frac{R}{C_v} = \gamma - 1 \Rightarrow C_v = \frac{R}{\gamma - 1}$$

$$C = \frac{R}{\gamma_1 - 1} + \frac{R}{1 - \gamma_2} = C_v + \frac{R}{1 - \gamma_2}$$

Derivation of Work done in a polytropic Process.

$$\Delta Q = n R C_{Poly} \Delta T$$

$$= n R \left( C_v + \frac{R}{1 - \gamma} \right) (T_2 - T_1)$$

$$= n R C_v \Delta T + \frac{n R \Delta T}{1 - \gamma}$$

$$= \Delta U + \Delta W$$

So  $\Delta W = \text{Work done} = \frac{n R \Delta T}{1 - \gamma}$  | Where Polytropic Process is  $PV^\gamma = C$

Gravitation by Prof. Subhashish Chattopadhyay SKMClasses Bangalore Useful for IIT-JEE, CBSE, I.Sc. PU-II, Boards, CET, CEE, PET, IGCSE IB AP-Physics and other exams

Heat or Thermodynamics 3 ) Work done calculations in various situations

**One mole of an ideal gas is taken round the cyclic process  $ABCA$  as shown in the figure. Calculate:**

- (i) **The work done by the gas.**
- (ii) **The heat rejected by the gas in the path  $CA$  and the absorbed by the gas in the path  $BC$ .**
- (iii) **The net heat absorbed by the gas in the path  $BC$ .**
- (iv) **The maximum temperature attained by the gas during the cycle.**

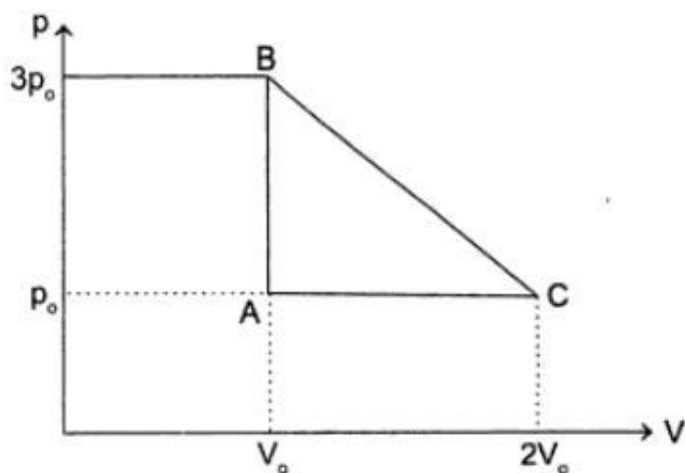

**Solution**

- (i) Work done by the gas during a cyclic process is equal to the area enclosed by its P-V diagram. In the present case,

$$\begin{aligned}W &= \text{area of } \triangle ABC \\&= \frac{1}{2}(AC)(AB) \\&= \frac{1}{2}(2V_0 - V_0)(3p_0 - p_0) \\&= p_0 V_0\end{aligned}$$

- (ii) The path CA is an isobaric compression of one mole of an ideal gas from volume  $2V_0$  to  $V_0$ . The heat released in this path is

$$\begin{aligned}Q_1 &= n C_p \Delta T \\&= \left(\frac{3}{2}R\right)\left(\frac{p_0 \Delta V}{R}\right) \\&= \left(\frac{5}{2}p_0\right)(V_0 - 2V_0) = -\frac{5}{2}p_0 V_0\end{aligned}$$

The path AB is an isochoric expansion of one mole of an ideal gas from pressure  $p_0$  to  $3p_0$ . The heat released in this process is

$$\begin{aligned}Q_2 &= n C_v \Delta T \\&= \left(\frac{5}{2}R\right)\left(\frac{V_0 \Delta p}{R}\right) \\&= \left(\frac{3}{2}V_0\right)(3p_0 - p_0) = 3p_0 V_0\end{aligned}$$



(iii) In a cyclic process, the change in internal energy is zero. Hence

$$Q_{CA} + Q_{AB} + Q_{BC} = W$$

$$-\frac{5}{2}p_0V_0 + 3p_0V_0 + Q_{BC} = p_0V_0$$

$$\text{This gives } Q_{BC} = \frac{1}{2}p_0V_0$$

(iv) The path BC is a straight line path. It is represented by the expression

$$p - p_0 = \left( \frac{3p_0 - p_0}{V_0 - 2V_0} \right) (V - 2V_0)$$

$$= \left( \frac{-2p_0}{V_0} \right) (V - 2V_0)$$

$$\text{or } p = \frac{-2p_0}{V_0}V + 5p_0$$

Replacing  $p = \frac{RT}{V}$ , we get

$$T = -2\frac{p_0}{V_0R}V^2 + \frac{5V_0}{R}V$$

To determine  $T_{\max}$ , we set  $\frac{\partial T}{\partial V} = 0$

$$\text{i.e., } 0 = -\frac{2p_0}{V_0R}(2V) + \frac{5p_0}{R}$$

which gives  $V = \frac{5}{4} V_0$ .

With this  $T_{\max}$  is given by

$$\begin{aligned} T_{\max} &= -\frac{2p_0}{V_0 R} \left( \frac{5}{4} V_0 \right)^2 + \left( \frac{5p_0}{R} \right) \left( \frac{5}{4} V_0 \right) \\ &= \frac{p_0 V_0}{R} \left[ -\frac{25}{8} + \frac{25}{4} \right] \\ &= \frac{25 p_0 V_0}{8 R} \end{aligned}$$

Three moles of an ideal gas ( $C_p = \frac{7}{2} R$ ) at pressure  $p_A$  and temperature  $T_A$  is isothermally expanded to twice its initial volume. It is then compressed at constant pressure to its original volume. Finally the gas is compressed at constant volume to its original pressure  $p_A$ . (i) Sketch  $p$ - $V$  and  $p$ - $T$  diagrams for the complete process. (b) Calculate the net work done by the gas and net heat supplied to the gas during the complete process. [IIT 1991]

**Solution.**

(a)

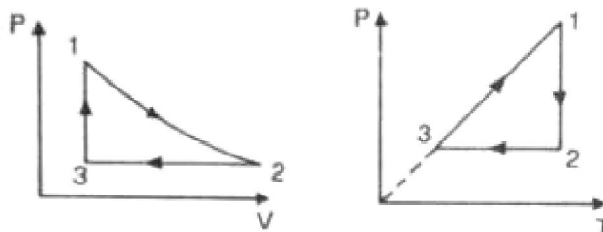

(b) In the process  $1 \rightarrow 2$  the state changes from  $(p_A, V, T_A)$  to  $(p_2, 2V, T_A)$ .

$$\text{Hence } p_2 = \frac{p_A}{2}$$

$$\text{Here } \Delta U = 0 \quad \Delta W = \int_V^{2V} p dV = 3RT_A \ln 2, \quad \Delta Q = \Delta U + \Delta W = \Delta W$$

In the process  $2 \rightarrow 3$  the state changes from  $\left( \frac{p_A}{2}, 2V, T_A \right)$  to  $(p_A/2, V, T_3)$  so that  $\frac{p_A}{2} \times \frac{2V}{T_A} = \frac{p_A/2 \times V}{T_3}$  or  $T_3 = T_A/2$

$$\gamma = \frac{C_p}{C_v} = \frac{C_p}{C_p - R} = \frac{\frac{7}{2}R}{\frac{7}{2}R - R} = \frac{7}{5}$$

$$\therefore \Delta U = -\frac{3RT_A}{\left(\frac{7}{5} - 1\right) \times 2} = -\frac{15RT_A}{4}$$

$$\Delta W = \int_{2V}^V p dV = \frac{p_A}{2} (V - 2V) = -\frac{p_A V}{2} = -\frac{3RT_A}{2}$$

$$\therefore \Delta Q = \Delta U + \Delta W = -\frac{15}{4} RT_A - \frac{3}{2} RT_A = -\frac{21RT_A}{4}$$

In the process 3  $\rightarrow$  1, the state changes from  $\left(\frac{p_A}{2}, V, \frac{T_A}{2}\right)$  to  $(p_A, V, T)$  that

$$\frac{p_A/2 \times V}{T_A/2} = \frac{p_A V}{T} \quad \text{or} \quad T = T_A$$

$$\Delta U = 3C_v \left(T_A - \frac{T_A}{2}\right) = \frac{3R}{\frac{7}{5} - 1} \times \frac{T_A}{2} = \frac{15}{4} RT_A$$

$$\Delta W = 0$$

$$\therefore \Delta Q = \Delta U = \frac{15}{4} RT_A$$

$$\therefore \text{Net } \Delta W = 3RT_A \ln 2 - \frac{3}{2} RT_A + 0 = 3RT_A \left(\ln 2 - \frac{1}{2}\right)$$

$$\text{Net } \Delta Q = 3RT_A \ln 2 - \frac{21RT_A}{4} + \frac{15RT_A}{4} = 3RT_A \left(\ln 2 - \frac{1}{2}\right)$$

A certain volume of a gas (diatomic) expands isothermally at  $20^\circ\text{C}$  until its volume is doubled and then adiabatically until its volume is again doubled. Find the final temperature of the gas, given  $\gamma = 1.4$  and that there is  $0.1$  mole of the gas. Also calculate the work done in the two cases.  $R = 8.3 \text{ J mole}^{-1} \text{ K}^{-1}$ .

**Solution.**

We require  $T$ - $V$  relation to calculate the final temperature.

We have  $TV^{\gamma-1} = \text{constant} \therefore (273 + 20) \cdot V^{\gamma-1} = (273 + t)(2V)^{\gamma-1}$

$$\text{or } 273 + t = \frac{293}{2^{1.4-1}} = \frac{293}{2^{0.4}}$$

$$\begin{aligned} \log(273 + t) &= \log 293 - 0.4 \log 2 = \log 293 - 0.4 \times 0.3010 \\ &= 2.4669 - 0.1204 \end{aligned}$$

$$\text{or } \log(273 + t) = 2.3465$$

$$\text{or } 273 + t = \text{antilog } 2.3465$$

$$\text{or } 273 + t = 222.1$$

$$\therefore t = -50.9^\circ\text{C}$$

(i) Work done in isothermal process

$$\begin{aligned} &= nRT \log_e \frac{V_2}{V_1} = \frac{8.3}{10} \times 293 \log_e \frac{2V}{V} \quad \left( \because n = \frac{1}{10} \right) \\ &= 0.83 \times 293 \times 2.3 \log_{10} 2 \quad (\because \log_e x = 2.3 \log_{10} x) \\ &= 0.83 \times 293 \times 2.3 \times 0.3010 = 1.684 \times 10^2 \text{ J} \end{aligned}$$

$$\begin{aligned} \text{(ii) Work done in adiabatic process} &= \frac{nR(T - T^*)}{\gamma - 1} = \frac{0.83(293 - 222.1)}{1.4 - 1} \\ &= \frac{0.83 \times 70.9}{0.4} = 1.47 \times 10^2 \text{ J} \end{aligned}$$

*The volume of one mole of an ideal gas with the adiabatic exponent  $\gamma$  is changed according to the relation  $V = aT^\gamma$ , where  $a$  is a constant. Find the amount of heat absorbed by the gas in the process if the temperature is increased by  $\Delta T$ .*

**Solution.**

We have  $\Delta W = \int pdV$  and  $\Delta U = \int C_V dT$ , for an ideal gas  $pV = RT$ ,

$$\therefore \Delta W = \int_T^{T+\Delta T} \frac{RT}{V} dV = \int_T^{T+\Delta T} \frac{RT^2}{a} \left( -\frac{a}{T^2} dT \right) = -R\Delta T$$

$$\Delta U = \int_T^{T+\Delta T} \frac{R}{\gamma-1} dT = \frac{R\Delta T}{\gamma-1}$$

$$\therefore \Delta Q = \Delta U + \Delta W = \frac{R\Delta T}{\gamma-1} + (-R\Delta T) = \frac{(2-\gamma)R\Delta T}{\gamma-1}$$

**Two moles an ideal mono-atomic gas initially at pressure  $p_1$  and volume  $V_1$  undergo an adiabatic compression until its volume is  $V_2$ . Then, the gas is given heat  $Q$  at constant volume  $V_2$ .**

- (i) Sketch the complete process on a  $p$ - $V$  diagram.**
- (ii) Find the total work done by the gas, total change in its internal energy and the final temperature of the gas.**

**[Give your answer in terms of  $p_1$ ,  $V_1$ ,  $V_2$ ,  $Q$  and  $R$ ].**

**Solution**

- (i) Figure displays the  $p$ - $V$  diagram of the gas undergone the given two processes.

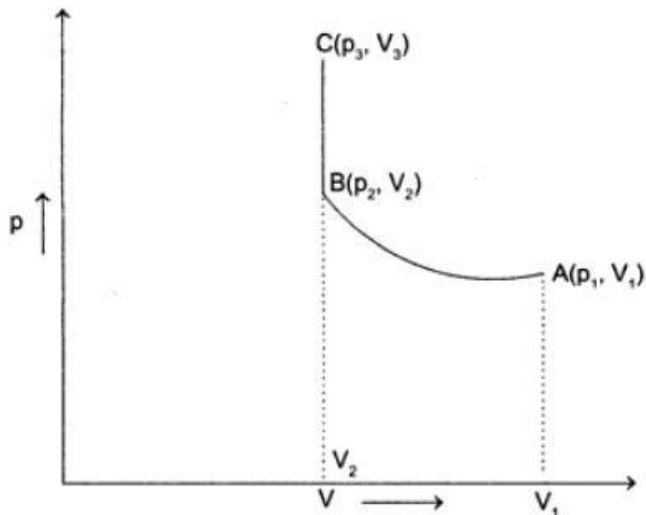

The curve A to B represents the adiabatic compression of the gas from the volume  $V_1$  to  $V_2$ . In this process the pressure of the gas increases  $p_1$  to  $p_2$ .

The line B to C represents increase in pressure of the gas as a result of giving here  $Q$  to the gas at constant volume. In this process, the pressure of the gas increases from  $p_2$  to  $p_3$ .

- (ii) (a) **Total work done by the gas**

Work done by the gas in adiabatic compression.

In an adiabatic process, since  $Q = 0$ , therefore from the first law of thermodynamics,

$$\Delta U_1 = -W_1$$

$$\text{or } W_1 = \Delta U_1 = -C_v \Delta T$$

$$= -C_v (T_2 - T_1)$$

$$\begin{aligned}
 &= -C_v \left( \frac{p_2 V_2}{nR} - \frac{p_1 V_1}{nR} \right) \\
 &= \frac{C_{v,m}}{R} (p_2 V_2 - p_1 V_1) \quad \dots(i)
 \end{aligned}$$

For a gas underdoes adiabatic process

$$P_1 V_1^\gamma = P_2 V_2^\gamma$$

$$\text{where } \gamma = \frac{C_{p,m}}{C_{v,m}}$$

From equation (i),

$$\begin{aligned}
 W_1 &= \frac{C_{v,m}}{R} \left[ \frac{p_1 V_1^\gamma}{V_2^\gamma} V_2 - p_1 V_1 \right] \\
 &= \frac{C_{v,m}}{R} p_1 V_1 \left[ \left( \frac{V_1}{V_2} \right)^{\gamma-1} - 1 \right]
 \end{aligned}$$

For a mono-atomic gas,

$$C_{v,m} = \frac{3}{2}R, \text{ and } C_{p,m} = \frac{5}{2}R$$

$$\therefore \gamma = \frac{5}{3}$$

$$\text{Hence, } W_1 = -\frac{3p_1 V_1}{2} \left[ \left( \frac{V_1}{V_2} \right)^{\frac{2}{3}} - 1 \right]$$

Since the volume is held constant, work done by the gas on heating at constant volume, therefore

$$W_2 = 0$$

**Total work don by the gas,**

$$W = W_1 = W_2$$

$$= -\frac{3p_1V_1}{2} \left[ \left( \frac{V_1}{V_2} \right)^{\frac{2}{3}} - 1 \right]$$

**(b) Total change in internal Energy**

Change in internal energy in adiabatic compression, as derived above,

$$\Delta U_1 = \frac{3p_1V_1}{2} \left[ \left( \frac{V_1}{V_2} \right)^{\frac{2}{3}} - 1 \right]$$

Change in internal energy on heating the gas at constant volume

$$\Delta U_2 = Q$$

Total change in the internal energy of the gas

$$\Delta U = \Delta U_1 + \Delta U_2$$

$$= \frac{3p_1V_1}{2} \left[ \left( \frac{V_1}{V_2} \right)^{\frac{2}{3}} - 1 \right] + Q.$$

**(c) Final temperature of the gas**

Change in temperature in adiabatic compression.

Since,  $\Delta U = C_v \Delta T$



$$\text{therefore, } \Delta T = \frac{\Delta U_1}{C_v}$$

$$\text{or } T_2 - T_1 = \frac{3p_1V_1}{2C_v} \left[ \left( \frac{V_1}{V_2} \right)^{2/3} - 1 \right]$$

$$T_2 - T_1 + \frac{3p_1V_1}{2\left(\frac{3}{2}nR\right)} \left[ \left( \frac{V_1}{V_2} \right)^{2/3} - 1 \right]$$

$$= \frac{p_1V_1}{nR} + \frac{p_1V_1}{nR} \left[ \left( \frac{V_1}{V_2} \right)^{2/3} - 1 \right]$$

$$= \frac{p_1V_1}{nR} \left( \frac{V_1}{V_2} \right)^{2/3}$$

Change in temperature on heating the gas

$$Q = C_v \Delta T = C_v (T_3 - T_2)$$

$$\text{or } T_3 = \frac{Q}{C_v} + T_2 = \frac{Q}{\left(\frac{3}{2}\right)nR} + \frac{p_1V_1}{nR} \left( \frac{V_1}{V_2} \right)^{2/3}$$

Since  $n = 2$ , therefore

$$T_3 = \frac{Q}{(3 \text{ mole})R} + \frac{p_1V_1}{(2 \text{ mole})R} \left( \frac{V_1}{V_2} \right)^{2/3}.$$

**Two moles of helium gas ( $\gamma = 5/3$ ) are initially at temperature  $27^\circ\text{C}$  and occupy a volume of 20 litres. The gas is expanded**

**at constant pressure until the volume is doubled. Then, it undergoes an adiabatic change until the temperature returns to its initial value.**

- (i) Sketch the process on a p-V diagram.
- (ii) What are the final volume and pressure of the gas?
- (iii) What is the work done by the gas?

**Solution**

(i)  $V_1 = 20 \times 10^{-3} \text{ m}^3$

$T_1 = 300 \text{ K}$

$n = 2 \text{ moles}$

$\gamma = \frac{5}{3}$

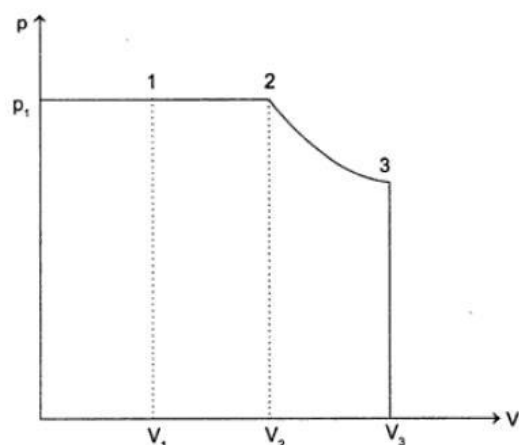

Process 1  $\rightarrow$  2 is isobaric expansion

$$p_1 V_1 = nRT_1$$

$$\therefore p_1 = \frac{nRT_1}{V_1}$$

$$= \frac{2 \times 8.3 \times 300}{20 \times 10^{-3}} = 2.49 \times 10^5 \text{ Nm}^{-2}$$

Now,  $V \propto T$

$$\therefore \frac{V_1}{T_1} = \frac{V_2}{T_2}$$

$$\text{or } T_2 = T_1 \times \frac{V_2}{V_1} = 300 \times \frac{2V_1}{V_1}$$

$$\therefore T_2 = 600 \text{ K}$$

$$V_2 = 40 \times 10^{-3} \text{ m}^3$$

Work done during process 1  $\rightarrow$  2,

$$(W)_{1-2} = p \times \Delta V$$

$$= 2.49 \times 10^5 \times (40 - 20) \times 10^{-3}$$

$$= 4980 \text{ J}$$

Process 2  $\rightarrow$  3 is adiabatic expansion

$$T_2 = 600 \text{ K}$$

$$p_2 = p_1 = 2.48 \times 10^5 \text{ N/m}^2$$

$$V_2 = 40 \times 10^{-3} \text{ m}^3$$

Given,  $T_2 V_2^{\gamma-1} = T_3 V_3^{\gamma-1}$ ,  $T_3 = T_1$

$$\therefore \left( \frac{V_3}{V_2} \right)^{\frac{5}{3}-1} = \frac{T_2}{T_1} = \frac{600}{300} = 2$$

$$\therefore V_3 = V_2 \times (2)^{3/2}$$

$$= 40 \times 10^{-3} (2)^{3/2}$$

$$= 113.14 \times 10^{-3} \text{ m}^3$$

$$\text{Now, } p_2 V_2^\gamma = p_3 V_3^\gamma$$

$$\therefore p_3 = p_2 \left( \frac{V_2}{V_3} \right)^\gamma$$

$$= 2.48 \times 10^5 \left( \frac{40}{113.14} \right)^{5/3} = 0.44 \times 10^5 \text{ N/m}^2$$

$$(W)_{2-3} = \frac{p_2 V_2 - p_3 V_3}{\gamma - 1}$$

$$= \frac{(2.49 \times 10^5)(40 \times 10^{-3}) - (0.44 \times 10^5)(113.14 \times 10^{-3})}{(5/3) - 1}$$

$$= 7472.8 \text{ J.}$$

(ii) Final volume,  $V_3 = 113.14 \times 10^{-3} \text{ m}^3$

Final pressure,  $p_3 = 0.44 \times 10^5 \text{ Nm}^{-2}$

(iii) Total work done by the gas =  $W =$

$$(W)_{1-2} + (W)_{2-3}$$

$$= 4980 + 7472.8 = 12452.8 \text{ J.}$$

Work done example in Isothermal expansion

A gram mole of a gas at  $127^\circ \text{C}$  expands isothermally until its volume is doubled. Find the amount of work done.

(a) 238 cal

(b) 548 cal

(c) 548 J

(d) 238 J

$$(b) W = 2.303 RT \log_{10} \left( \frac{V_2}{V_1} \right)$$

$$= 2.303 \times 8.311 \times 400 \times \log_{10} 2$$

$$= 2310.1 \text{ J} = 548 \text{ cal.}$$

Example in Isothermal Expansion

**How much work is done by an ideal gas in expanding isothermally from an initial volume of 3 litres of 20 atm to a final volume of 24 litres?**

**Solution** In isothermal process at temperature T,

$$W = 2.303nRT \log \frac{V_2}{V_1}$$

or  $W = 2.303(p_1 V_1) \log \frac{V_2}{V_1}$

(using  $p_1 V_1 = nRT$ )

$$= 2.303 (20 \times 3) \log \frac{P_1}{P_2} \text{ lt. atm}$$

$$= 2.303 \times 60 \log 8 (101) \text{ J}$$

$$= \mathbf{1.26 \times 10^4 \text{ J}}$$

Work done by the gas

The ratio of work done by an ideal diatomic gas to the heat supplied by the gas in an isobaric process is

(a)  $\frac{5}{7}$

(b)  $\frac{3}{5}$

(c)  $\frac{2}{7}$

(d)  $\frac{5}{3}$

Ans - (c)  $\Delta U = nC_v\Delta T = n \frac{5}{2} R\Delta T$

$$\Delta Q = nC_p\Delta T = n \frac{7}{2} R\Delta T$$

$$W = \Delta Q - \Delta U = \frac{n7}{2} R\Delta T - nR\Delta T$$

$$\frac{W}{Q} = \frac{2}{7}$$



One mole of a gas which obeys the relation  $Pv = RT$ , where  $R = 8.314 \text{ J/mol K}$  is initially at  $300 \text{ K}$  and  $0.1 \text{ MPa}$ . The gas is heated at constant volume till the pressure rises to  $0.5 \text{ MPa}$  and then allowed to expand at constant temperature till the pressure reduces to  $0.1 \text{ MPa}$ . Finally the gas is returned to its original state by compressing at constant pressure. Calculate the work done by the gas in each of the processes and also estimate the net work done by the gas.

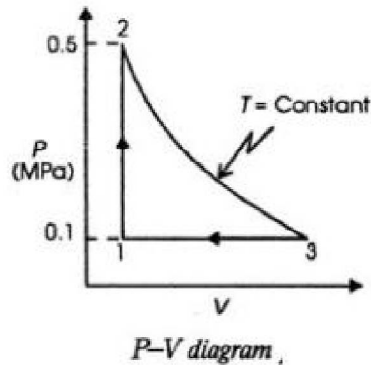

**Solution** The process followed by the gas is shown in Fig.2.12. Work done by the gas during process 1-2 is given by

$$W_{1-2} = \int_1^2 Pdv = 0 \quad (\text{since } dv = 0)$$

We know  $P_1v_1 = RT_1$  and  $P_2v_2 = RT_2$ . Therefore

$$\frac{T_2}{T_1} = \frac{P_2v_2}{P_1v_1} = \frac{P_2}{P_1} = \frac{0.5 \times 10^6}{0.1 \times 10^6} = 5 \quad (\text{since } v_2 = v_1)$$

or  $T_2 = 5T_1 = 5 \times 300 = 1500 \text{ K}$

Work done by the gas during process 2-3 is given by

$$W_{2-3} = \int_2^3 Pdv = \int_2^3 \frac{RT}{v} dv = RT_2 \ln \frac{v_3}{v_2}$$

We know  $P_2v_2 = P_3v_3$  (since  $T_2 = T_3$ ). Therefore

$$\frac{v_3}{v_2} = \frac{P_2}{P_3} = \frac{0.5 \times 10^6}{0.1 \times 10^6} = 5$$

Hence  $W_{2-3} = RT_2 \ln 5 = 8.314 \times 1500 \times \ln 5 = 20.071 \text{ kJ}$ . Work done during process 3-1 is given by

$$W_{3-1} = \int_3^1 Pdv = P_1(v_1 - v_3) = P_1v_1 \left(1 - \frac{v_3}{v_1}\right) = RT_1 \left(1 - \frac{v_3}{v_1}\right)$$

We know  $P_1v_1 = RT_1$  and  $P_3v_3 = RT_3$

$$\text{or } \frac{v_3}{v_1} = \frac{RT_3}{P_3} \cdot \frac{P_1}{RT_1} = \frac{T_3}{T_1} \quad (\text{since } P_1 = P_3). \text{ Therefore}$$

$$W_{3-1} = RT_1 \left(1 - \frac{v_3}{v_1}\right) = RT_1 \left(1 - \frac{T_3}{T_1}\right) = 8.314 \times 300 \left(1 - \frac{1500}{300}\right) = -9.977 \text{ kJ}$$

$$\text{Net work done by the gas, } W = W_{1-2} + W_{2-3} + W_{3-1} = 0 + 20.071 - 9.977 = 10.094 \text{ kJ}$$

Work done by the gas

**A sample of ideal gas ( $\gamma = 1.4$ ) is heated at constant pressure. If an amount of 140 J of heat is supplied to the gas, find:**

- (i) **The change in internal energy of the gas.**
- (ii) **The work done by the gas.**

**Solution** Suppose, the sample contains  $n$  moles. Also, suppose the volume changes from  $V_1$  to  $V_2$  and the temperature changes from  $T_1$  to  $T_2$ .

The heat supplied is given by

$$\Delta Q = nC_p(T_2 - T_1)$$

- (i) **Change in internal energy**

$$\Delta U = nC_v(T_2 - T_1)$$

$$= \frac{C_v}{C_p} nC_p(T_2 - T_1)$$

$$= \frac{C_v}{C_p} \Delta Q = \frac{140 \text{ J}}{1.4} = \mathbf{100 \text{ J}}$$

- (ii) **Work done by gas**

$$\begin{aligned} \Delta W &= \Delta Q - \Delta U \\ &= 140 \text{ J} - 100 \text{ J} = \mathbf{40 \text{ J}} \end{aligned}$$



work done by the gas

**A sample of gas ( $\gamma = 1.5$ ) is taken through an adiabatic process in which the volume is compressed from  $1600 \text{ cm}^3$  to  $400 \text{ cm}^3$ . If the initial pressure is  $150 \text{ kPa}$ ,**

- (i) **What is the final pressure?**
- (ii) **How much work is done by the gas in the process?**

**Solution**

- (i) For an adiabatic process

$$p_1 V_1^\gamma = p_2 V_2^\gamma$$

$$\begin{aligned}\text{Thus, } p_2 &= p_1 \left( \frac{V_1}{V_2} \right)^\gamma \\ &= (150 \text{ kPa}) \left( \frac{1600}{400} \right)^{\frac{3}{2}} \\ &= \mathbf{1200 \text{ kPa}}\end{aligned}$$

- (ii) Work done by the gas in an adiabatic process

$$\begin{aligned}W &= \frac{p_1 V_1 - p_2 V_2}{\gamma - 1} \\ &= \frac{(150 \text{ kPa})(1600 \text{ cm}^3) - (1200 \text{ kPa})(400 \text{ cm}^3)}{1.5 - 1} \\ &= \frac{240 \text{ J} - 480 \text{ J}}{0.5} = \mathbf{-480 \text{ J}}\end{aligned}$$

A cyclic process for an ideal monatomic gas ( $C_V = 12.5 \text{ J mol}^{-1} \text{ K}^{-1}$ ) is represented in the figure. The temperatures at 1, 2 and 3 are 300 K, 600 K and 455 K, respectively. Compute the values of  $\Delta Q$ ,  $\Delta U$  and  $\Delta W$  for each of the processes. The process from 2 to 3 is adiabatic.

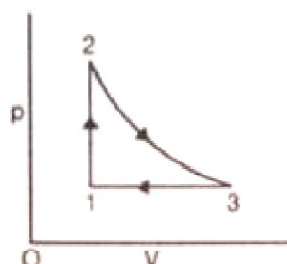

**Solution.**

In the process from 1 to 2

$$\Delta W = \int p dV = 0 \quad (\text{volume remains constant})$$

$$\begin{aligned} \Delta Q &= \int_{T_1}^{T_2} C_V dT = C_V(T_2 - T_1) \\ &= 12.5(600 - 300) = 3750 \text{ joules} \end{aligned}$$

By the first law of thermodynamics

$$\begin{aligned} \Delta Q &= \Delta U + \Delta W \quad \text{or} \quad \Delta U = \Delta Q - \Delta W \\ &= 3750 - 0 = 3750 \text{ joules} \end{aligned}$$

In the process 2 to 3  $\Delta Q = 0$   
(since the process is adiabatic)

$$\begin{aligned}\Delta W &= \frac{R(T_2 - T_3)}{\gamma - 1} \\ &= C_V (T_2 - T_3) \quad \left( \because C_V = \frac{R}{\gamma - 1} \right) \\ &= 12.5(600 - 455) = 12.5 \times 145 = 1812.5 \text{ joules}\end{aligned}$$

$$\therefore \Delta U = \Delta Q - \Delta W = 0 - 1812.5 = -1812.5 \text{ joules}$$

$$\text{In the process from 3 to 1, } \Delta W = \int_V^{V_1} p dV = p(V_1 - V_3) = pV_1 - pV_3$$

$$\begin{aligned}\text{or } \Delta W &= R(T_1 - T_3) \quad (\because pV = RT) \\ &= 8.31(300 - 455) = -1288 \text{ joules}\end{aligned}$$

$$\begin{aligned}\Delta Q &= \int_{T_3}^{T_1} C_p dT = C_p(T_1 - T_3) = 1.67 \times 12.5 \times (300 - 455) \quad \left( \because \gamma = \frac{C_p}{C_v} \right) \\ &= -3235.6 \text{ joules.}\end{aligned}$$

By the first law of thermodynamics

$$\begin{aligned}\Delta Q &= \Delta U + \Delta W \\ \therefore \Delta U &= \Delta Q - \Delta W = (-3235.6) - (-1288) = 1989.1 \text{ joules}\end{aligned}$$

Question on Total Heat rejected

**A thermodynamic system is taken through the cycle  $a b c d a$ .**

**(i) Calculate the work done by the gas during the parts  $ab$ ,  $bc$ ,  $cd$  and  $da$ .**

(ii) Find the total heat rejected by the gas during the process.

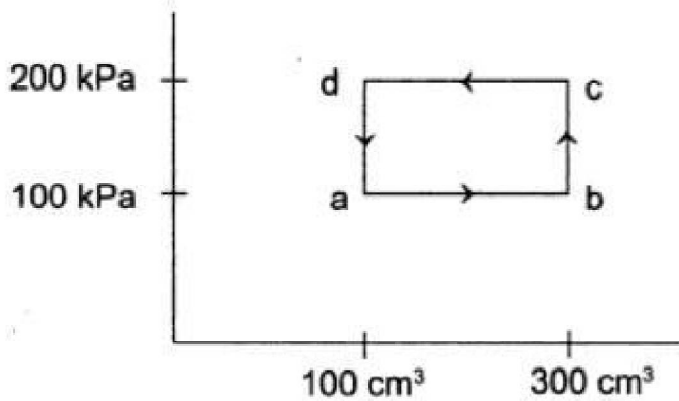

**Solution**

(i) Work done during the part  $ab = \int_a^b p dV$

$$\begin{aligned} &= (100 \times \text{Pa}) \int_a^b dV \\ &= (100 \text{ kPa}) (300 \text{ cm}^3 - 100 \text{ cm}^3) \\ &= 20 \text{ J} \end{aligned}$$

The work done during  $bc$  is zero as the volume does not change. The work done during  $cd$ ,

$$\begin{aligned} &= \int_d^c p dV \\ &= (200 \text{ kPa}) (100 \text{ cm}^3 - 300 \text{ cm}^3) \\ &= -40 \text{ J} \end{aligned}$$

The work done during  $da$  is zero as the volume does not change.

(ii) Total work done by the system during the cycle  $a b c d a$ .

$$\Delta W = 20 \text{ J} - 40 \text{ J}$$

$$= -20 \text{ J}$$

Change in the internal energy,  $\Delta U = 0$ , as the initial state is the same as the final state.

$$\begin{aligned} \text{Thus, } \Delta Q &= \Delta U + \Delta W \\ &= -20 \text{ J} \end{aligned}$$

So, the system rejects **20 J** of heat during the cycle.

- Question with P T diagram

3 moles of an ideal monoatomic gas perform a cycle shown in Fig. The gas temperatures  $T_A = 400 \text{ K}$ ,  $T_B = 800 \text{ K}$ ,  $T_C = 2400 \text{ K}$ ,  $T_D = 1200 \text{ K}$ . Find the work done by the gas.

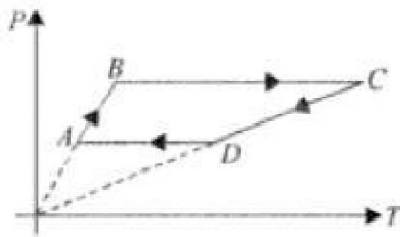

Solution :

$$W_{BC} = 3R(T_C - T_B)$$

$$W_{AB} = W_{CD} = 0$$

because the processes are isochoric

$$W_{DA} = 3R(T_A - T_D)$$

Total work done

$$\begin{aligned} W_{BC} + W_{DA} &= 3R(T_A + T_C - T_B - T_D) \\ &= 3R(400 + 2400 - 800 - 1200) \\ &= 2400R = 20 \text{ kJ} \end{aligned}$$

Work done by the gas

**Two moles of Helium gas ( $\gamma = \frac{5}{3}$ ) are initially at  $27^\circ \text{C}$  and occupy a volume of 20 litres. The gas is first expanded at constant pressure until the volume is doubled. Then it undergoes an adiabatic change until the temperature returns to its initial value.**

- (i) Sketch the process in a p–V diagram.
- (ii) What is the final volume and pressure of the gas?
- (iii) What is the work done by the gas?

**Solution**

- (i) The process is shown in the figure. During the part *ab*, since the pressure is constant, we have

$$\frac{P_a V_a}{T_a} = \frac{P_b V_b}{T_b}$$

$$\begin{aligned} \text{or } T_b &= \frac{V_b}{V_a} T_a \\ &= 2T_a = 600 \text{ K} \end{aligned}$$

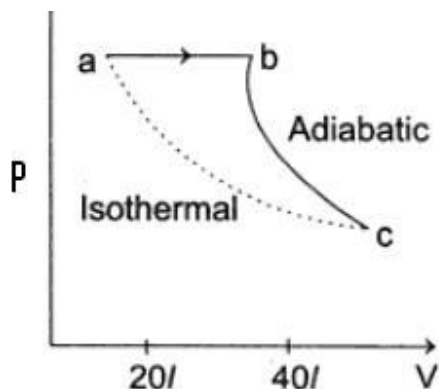

During the part  $bc$ , the gas is adiabatically returned to the temperature  $T_a$ . The point  $a$  and point  $c$  are on the same isothermal. Thus, we draw an adiabatic curve  $bc$  and an isothermal from  $a$  and look for the point of intersection  $c$ . That is the final state.

(ii) From the isothermal  $ac$ ,

$$p_a V_a = p_b V_b \quad \dots(i)$$

And from the adiabatic curve  $bc$ ,

$$p_b V_b^\gamma = p_c V_c^\gamma$$

$$\text{or } p_a (2V_a)^\gamma = p_c V_c^\gamma$$

Dividing equation (ii) by equation (i), we get

$$2^\gamma (V_a)^{\gamma-1} = (V_c)^{\gamma-1}$$

$$\begin{aligned} \text{or } V_c &= 2^{\frac{\gamma}{\gamma-1}} V_a 4\sqrt{2} V_a \\ &= 113 \text{ litres} \end{aligned}$$

From equation (i),

$$\begin{aligned} p_c &= \frac{p_a V_a}{V_c} = \frac{nRT}{V_c} \\ &= \frac{2 \text{ mol} \times (8.3 \text{ J/mol-K})(300 \text{ K})}{113 \times 10^{-3} \text{ m}^3} \\ &= 4.4 \times 10^4 \text{ Pa} \end{aligned}$$

(iii) Work done by the gas in the part *ab*

$$\begin{aligned} &= p_a (V_b - V_a) \\ &= p_a V_b - p_a V_a = nRT_2 - nRT_1 \\ &= 2 \text{ mole} \times (8.3 \text{ J/mol-K}) \times (600 \text{ K} - 300 \text{ K}) \\ &= 4980 \text{ J} \end{aligned}$$

Work done in the adiabatic part *bc*

$$\begin{aligned} &= \frac{p_b V_b - p_c V_c}{\gamma - 1} \\ &= \frac{nR(T_2 - T_1)}{\gamma - 1} = \frac{4980}{\frac{5}{3} - 1} = 7470 \text{ J} \end{aligned}$$

Net work done by the gas = 4980 J + 7470 J = **12450 J.**



Example of cycle given P T diagram

**Two moles of helium gas undergo a cyclic process as shown in the figure. Assuming the gas to be ideal, calculate the following quantities in this process:**

- (i) **The net change in the heat energy.**
  - (ii) **The net work done.**
  - (iii) **The net change in internal energy.**
- [ $R = 8.32 \text{ J mol}^{-1}$ ]**

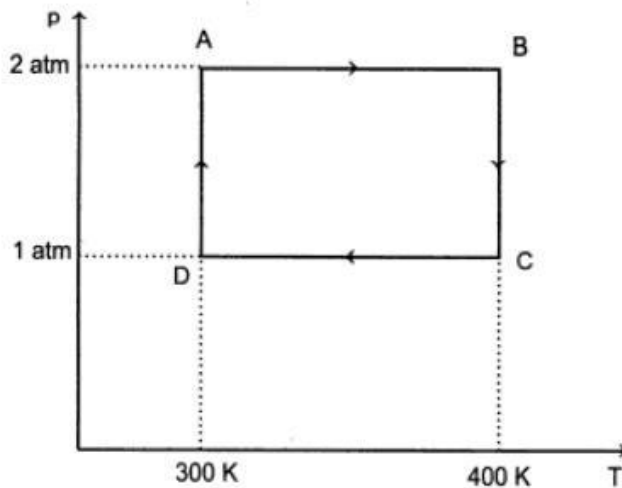

**Solution** Number of moles,  $n = 2$   
Helium is a mono-atomic gas.

$$\therefore C_V = \frac{3}{2}R$$

$$C_P = \frac{5}{2}R$$

The gas undergoes cyclic process.

Since, internal energy is property of the system, the net change in internal energy during the cyclic process is zero.

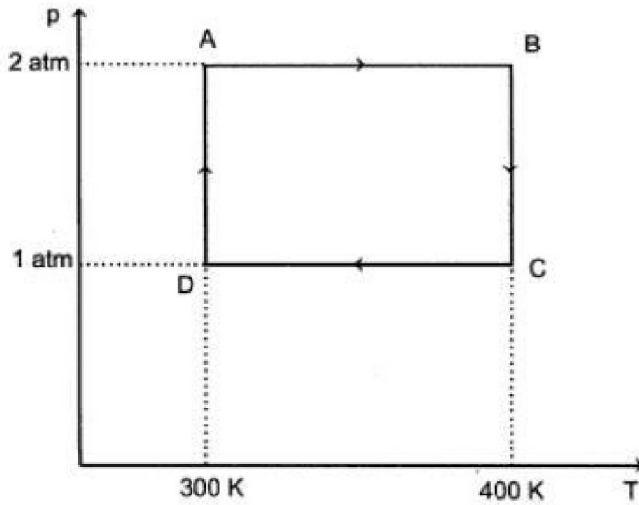

Hence, according to the first law of thermodynamics, the net change in the heat energy is equal to the net work done.

$$(i) (\Delta Q)_{Net} = (\Delta Q)_{AB} + (\Delta Q)_{BC} + (\Delta Q)_{DA}$$

$$\begin{aligned} (\Delta Q)_{AB} &= n \times C_p \times (T_B - T_A) \\ &= 2 \times \frac{5}{2} \times 8.32(400 - 300) = 4160 \text{ J} \end{aligned}$$

Since Process BC is isothermal, therefore  $\Delta U = 0$

$$\begin{aligned} (\Delta Q)_{BC} &= (\Delta W)_{BC} \\ &= nRT \ln\left(\frac{V_C}{V_B}\right) = nRT \ln\left(\frac{P_B}{P_C}\right) \\ &= 2 \times 8.32 \times 400 \ln\left(\frac{2}{1}\right) = 4613.6 \text{ J} \end{aligned}$$

$$\begin{aligned} (\Delta Q)_{DA} &= nRT \ln\left(\frac{P_D}{P_A}\right) \\ &= 2 \times 8.32 \times 300 \ln\left(\frac{2}{1}\right) = -3460.2 \text{ J} \end{aligned}$$



Efficiency of Refrigerator is given by

### Efficiency of Refrigerator

$$\eta = 1 - \frac{T_c}{T_H}$$

So in this case efficiency  $\eta = 1 - (273 / 303) = 0.099 \approx (\text{approx}) 0.1$  or 10%

Refrigerator Problem

**A refrigerator works between 0°C and 27°C. Heat is to be removed from the refrigerated space at the rate of 50 kcal/minute, the power of the motor of the refrigerator is :**

- (a) 0.346 kW                      (b) 3.46 kW  
(c) 34.6 kW                        (d) 346 kW

Ans : a )

$$\begin{aligned} \frac{T_2}{T_1 - T_2} &= \frac{Q_2}{W} \\ \frac{273}{300 - 273} &= \frac{50,000}{W} \\ W &= \frac{27 \times 50,000}{273} \text{ cal / min} \\ P &= \frac{W}{t} = \frac{4.2 \times 27 \times 50,000}{60 \times 273} \text{ Joule / sec} \\ &= 346 \text{ watt} = 0.346 \text{ kW} \end{aligned}$$

### Efficiency of Refrigerator

$$\eta = 1 - \frac{T_c}{T_H}$$

So in this case efficiency  $\eta = 1 - (273 / 300) = 0.09 \approx$  or 9%

### Refrigerator Problem

An ideal refrigerator has a freezer at a temperature of  $-13^{\circ}\text{C}$ . The coefficient of performance of the engine is 5. The temperature of the air (to which heat is rejected) is :

- (a)  $320^{\circ}\text{C}$  (b)  $39^{\circ}\text{C}$  (c)  $325\text{ K}$  (d)  $325^{\circ}\text{C}$

Ans : b )

$$T_2 = 273 - 13 = 260, K = \frac{T_2}{T_1 - T_2}$$
$$5 = \frac{260}{T_1 - 260} \text{ or } T_1 - 260 = 52$$
$$T_1 = 312\text{ K}, T_2 = 312 - 273 = 39^{\circ}\text{C}$$

### Efficiency of Refrigerator

$$\eta = 1 - \frac{T_c}{T_h}$$

So in this case efficiency  $\eta = 1 - (260 / 312) = 0.16666 \approx (\text{approx}) 0.16667$  or  $16.67\%$

### Refrigerator Problem

A Carnot's engine works as a refrigerator between  $250\text{ K}$  and  $300\text{ K}$ . If it receives  $750$  calories of heat from the reservoir at the lower temperature, the amount of heat rejected at the higher temperature is :

- (a)  $900$  calories (b)  $625$  calories  
(c)  $750$  calories (d)  $1000$  calories

Ans : a )

$$\frac{750}{W} = \frac{250}{300 - 250}$$

$$\text{Heat rejected} = 750 + 150 = 900 \text{ cal.}$$

### Efficiency of Refrigerator

$$\eta = 1 - \frac{T_c}{T_H}$$

So in this case efficiency  $\eta = 1 - (250 / 300) = 0.166666 \approx (\text{approx}) 0.16667$  or 16.67%

### Refrigerator Problem

A refrigerator having a coefficient of performance of 5 is run by an electric motor of power 1.2 kW. How much is the mass of ice formed from water at 0°C per hour by the refrigerator ?

- (a) nearly 6 kg                      (b) nearly 60 kg  
(c) nearly 25.2 kg                  (d) 252 kg

Ans : b )

$$5 = \frac{Q_2}{Pt} \quad \text{or} \quad Q_2 = 5 \times 1.2 \times 1000 \times 3600 \text{ J}$$

$$Q = 216 \times 10^5 \text{ J} = 5142857 \text{ cal.}$$

$$\therefore Q = mL \quad \text{or} \quad m = Q/L = 64.2 \text{ kg} \quad \therefore m \approx 60 \text{ kg}$$



Heat or Thermodynamics 5 ) Concept of "free expansion"

**Free expansion:**

If a system (a gas), expands in such a way that no heat enters or leaves the system (adiabatic process) and also no work is done by or on the system, then the expansion is called the free expansion.

Consider an adiabatic vessel with rigid walls divided into two parts. One containing a gas and the other evacuated. When the partition is suddenly broken, the gas rushes into the vacuum and expands freely.

∴ Net change in internal energy  
 $U_f - U_i = \Delta Q - W$  as  $\Delta Q = 0$  and  $W = 0$   
 ∴  $U_i = U_f$

The initial and final internal energies are equal in free expansion.

*One mole of an ideal diatomic gas underwent an adiabatic expansion from 298 K, 15.00 atm, and 5.25 L to 2.50 atm against a constant external pressure of 1.00 atm. What is the final temperature of the system?*

**Plan** This is an isobaric adiabatic expansion against constant external pressure, but overall pressure decreases (volume increases, gas expands). Final temperature  $T_2$  is given by P-V-T relation as:

$$T_2 = T_1 \left( \frac{C_V + P_{\text{ext}} \frac{R}{P_1}}{C_V + P_{\text{ext}} \frac{R}{P_2}} \right)$$

**Solution** For diatomic gas  $C_V = \frac{5}{2}R$ ,  $T_1 = 298$  K,  $T_2 = ?$ ,

$P_2 = 2.50$  atm,  $P_1 = 15.00$  atm,  $P_{\text{ext}} = 1.00$  atm

$$\begin{aligned} \therefore T_2 &= 298 \left( \frac{\frac{5}{2}R + \frac{R}{15}}{\frac{5}{2}R + \frac{R}{2.5}} \right) \\ &= 263.7 \text{ K} \end{aligned}$$



**One mole of a gas is put under a weightless piston of a vertical cylinder at temperature  $T$ . The space over the piston is atmosphere. How much work should be performed to increase isothermally the**

**volume under the piston to twice the volume (neglect friction of piston).**

**Solution** Let  $A$  be the area of piston, therefore

$$F + pA = p_0 A$$

or  $F = (p_0 - p) A$

Work done by agent is given by

$$\begin{aligned} W &= \int_v^{\eta v} (p_0 - p) A dx \\ &= \int_v^{\eta v} (p_0 - p) dV \\ &= \int_v^{\eta v} p_0 dV - \int_v^{\eta v} p dV \end{aligned}$$

Gravitation by Prof. Subhashish Chattopadhyay SKMClasses Bangalore Useful for IIT-JEE, CBSE, I.Sc. PU-II, Boards, CET, CEE, PET, IGCSE IB AP-Physics and other exams

$$= p_0(\eta - 1)V - \int_v^{\eta v} nRT \frac{dV}{V}$$

(since  $pV = nRT$ )

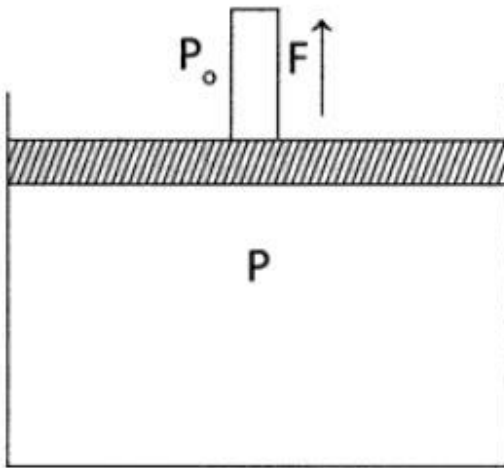

$$= p_0(\eta - 1)V - nRT \log_e \eta$$

$$= nRT [(\eta - 1) \log_e \eta]$$

where,  $\eta = 2$  and  $n = 1$

$$\mathbf{W = RT [1 - \log_e 2]}$$

Gravitation by Prof. Subhashish Chattopadhyay SKMClasses Bangalore Useful for IIT-JEE, CBSE, I.Sc. PU-II, Boards, CET, CEE, PET, IGCSE IB AP-Physics and other exams

Adiabatic free expansion

**Two vessels of volume  $V_1$  and  $V_2$  contain the same ideal gas. The pressure in the vessels are  $p_1$  and  $p_2$  and the temperatures are  $T_1$  and  $T_2$  respectively. The two vessels are now connected to each other through a narrow tube. Assuming that no heat is exchanged between the surroundings and the vessels, find the common pressure and temperature attained after the connection.**

**Solution**

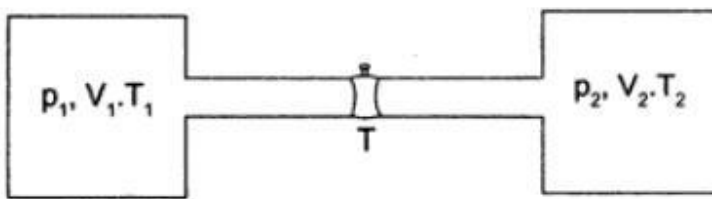

The amount of gas in vessel 1 is

$$n_1 = \frac{p_1 V_1}{RT_1}$$

If  $p'$  and  $T'$  are the common pressure and temperature after the connection is made, the amount are

$$n'_1 = \frac{p'V_1}{RT'}$$

and  $n'_2 = \frac{p'V_2}{RT'}$

We have,  $n_1 + n_2 = n'_1 + n'_2$

or  $\frac{p_1V_1}{RT_1} + \frac{p_2V_2}{RT_2} = \frac{p'V_1}{RT'} + \frac{p'V_2}{RT'}$

or  $\frac{p'}{T'} = \frac{1}{V_1 + V_2} \left( \frac{p_1V_1}{T_1} + \frac{p_2V_2}{T_2} \right)$

or  $\frac{T'}{P'} = \frac{T_1T_2(V_1 + V_2)}{p_1V_1T_2 + p_2V_2T_1}$

As the vessels have fixed volume, no work done by the gas plus the vessels system. Also, no heat is exchanged with the surroundings.

Thus, the internal energy of the total system remains constant. The internal energy of an ideal gas is

$$U = nC_vT = C_v \frac{pV}{R}$$

Internal energy of the gases before the connection

$$= \frac{C_v p_1 V_1}{R} + \frac{C_v p_2 V_2}{R}$$

And Internal energy of the gas after the connection

$$= \frac{C_v p' (V_1 + V_2)}{R}$$

Neglecting the change in internal energy of the vessels (the heat capacity of the vessels is assumed negligible).

$$\frac{C_v p_1 V_1}{R} + \frac{C_v p_2 V_2}{R} = \frac{C_v p' (V_1 + V_2)}{R}$$

or 
$$p' = \frac{p_1 V_1 + p_2 V_2}{V_1 + V_2}$$

From equation (i), 
$$T' = \frac{T_1 T_2 p_1 V_1 + p_2 V_2}{p_1 V_1 T_2 + p_2 V_2 T_1}$$

Question on work done

**One mole of an ideal gas is contained under a weightless piston of a vertical cylinder at a temperature  $T$ . The space over the piston opens into the atmosphere. What work has to be performed in order to increase isothermally the gas volume under the piston  $\eta$  times by slowly raising the piston? Neglect friction.**

Solution :

Let A be the area of cross section

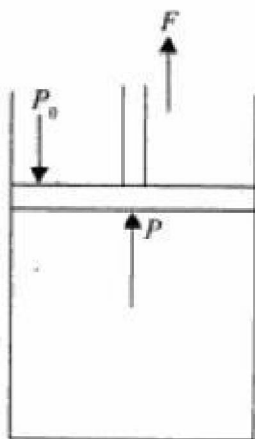

$$F + PA = P_0 A$$

$$F = (P_0 - P) A$$

Work done by the agent

$$W = \int_V^{\eta V} F dx = \int_V^{\eta V} (P_0 - P) A dx$$

$$= \int_V^{\eta V} (P_0 - P) dV$$

$$= P_0(\eta - 1) V - \int_V^{\eta V} nRT \frac{dV}{V}$$

$$= RT [(\eta - 1) - n \log_e \eta]$$

Heat or Thermodynamics 6 ) Ingen Housz's experiment of identical rods

**Ingen-Housz's experiment** Ingen Housz showed that if a number of identical rods of different metals are coated with wax and one of their ends is put in boiling water, then in steady state, the square of length of the bar over which wax melts is directly proportional to the thermal conductivity of the metal. That is,

$$\frac{K}{L^2} = \text{constant}$$

Heat or Thermodynamics 7 ) Concept of Internal Energy at Room temperature

*Find the internal energy of air in a room of volume  $40 \text{ m}^3$  at 1 standard atmospheric pressure.*

**Solution.**

We have  $U = \frac{pV}{\gamma - 1}$  for a perfect gas

Air is diatomic and therefore its  $\gamma$  is 1.4.

$$\therefore U = \frac{10^5 \times 40}{1.4 - 1} \quad (p = 1 \text{ atm} = 10^5 \text{ Nm}^{-2}) = 10^7 \text{ joules.}$$

Question in Internal Energy

**The internal energy of a mono-atomic ideal gas is  $1.5 nRT$ . One mole of helium is kept in a cylinder of cross-section  $8.5 \text{ cm}^2$ . The cylinder is closed by a light frictionless piston. The gas is heated slowly in a process during which a total**

**of 42 J heat is given to the gas. If the temperature rised through 2° C, find the distance moved by piston. Atmospheric pressure = 100 kPa.**

**Solution** Change in internal energy of the gas

$$\begin{aligned}\Delta U &= 1.5 nRT \\ &= 1.5 (1 \text{ mole}) (8.3 \text{ J/mol} - \text{K}) (2\text{K}) \\ &= 24.9 \text{ J}\end{aligned}$$

Heat given to the gas = 43 J

$$\begin{aligned}\text{Work done by the gas is } \Delta W &= \Delta Q - \Delta U \\ &= 42 \text{ J} - 24.9 \text{ J} = 17.1 \text{ J}\end{aligned}$$

If the distance moved by the piston is  $x$ , then the work done

$$\begin{aligned}\Delta W &= (100 \text{ kPa}) (8.5 \text{ cm}^2)x \\ &= 17.1 \text{ J}\end{aligned}$$

$$\text{Thus, } (10^5 \text{ N/m}^2) (8.5 \times 10^{-4} \text{ m}^2) x = 17.1 \text{ J}$$

$$\text{or } x = 0.2 \text{ m} = \mathbf{20 \text{ cm}}$$

Heat or Thermodynamics 8 ) Saturated vapor pressure problems

*A saturated water vapour ( $M = 18$ ) is contained in a vessel fitted with a piston at a temperature  $t = 100^\circ\text{C}$ . As a result of slow introduction of the piston a small fraction of the vapour  $\Delta m = 1 \text{ g}$  gets condensed. What amount of work is done over the gas?*

**Solution.**

Work done = decrease in internal energy of the gas

$$\begin{aligned}\text{Work done} &= U_i - U_f = \frac{m_i RT}{M} - \frac{m_f RT}{M} = \frac{\Delta m RT}{M} \\ \therefore \text{ Here, } W &= \frac{10^{-3} \times 8.3 \times (273 + 100)}{18 \times 10^{-3}} = 172 \text{ J}.\end{aligned}$$



Water of mass  $m = 1 \text{ kg}$  and  $M$  (mol. mass) = 18 turns completely into saturated vapour at standard atmospheric pressure. Assuming the saturated vapour to be an ideal gas find increment of internal energy of the system. Specific latent heat of steam is  $L = 2250 \text{ kJ/kg}$ .

**Solution.**

$$\Delta Q = \text{heat added to the system} = mL$$

$$\Delta W = \text{work done by the system} = p_0 (V_v - V_w)$$

$$\approx p_0 V_v = \frac{m}{M} RT$$

By the first law ( $\Delta Q = \Delta U + \Delta W$ ),

$$\Delta U = mL - \frac{m}{M} RT = m \left( L - \frac{RT}{M} \right)$$

$$\Delta U = 1 \left( 2250 \times 10^3 - \frac{8.3 \times 373}{18 \times 10^{-3}} \right) = 2.078 \times 10^6 \text{ J}$$

Heat or Thermodynamics 9 ) Mean free path

Mean free path of a gas molecule between 2 collisions

### Mean Free Path

all particles, including photons, suffer from collisions with other particles such that their path through space is very short the higher the densities. This typical path length is called the mean free path.

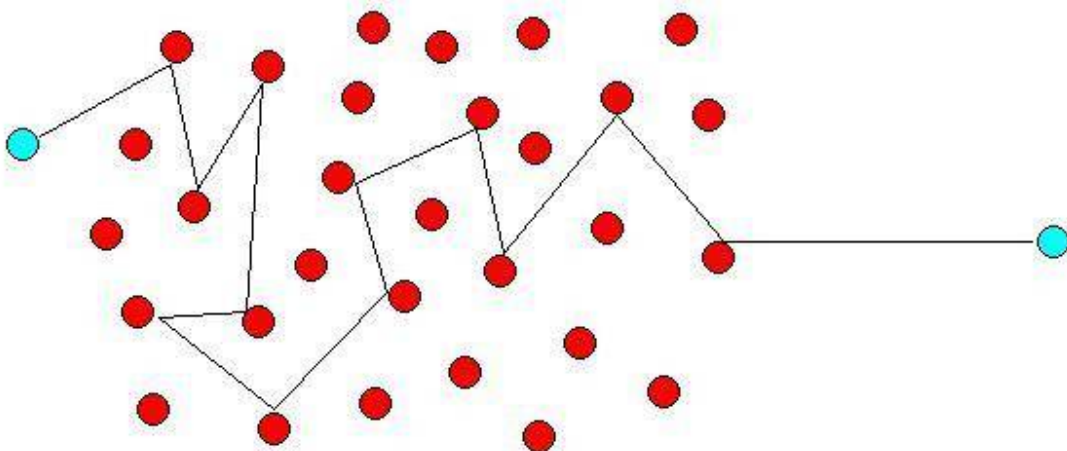

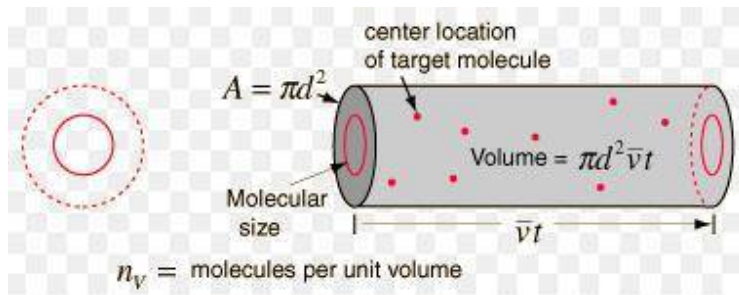

mean free path  $\lambda$  (the average distance travelled by a particle between collisions) to determine the best values for number of particles  $N$ , rms velocity  $V_{rms}$ , and box length  $L$ ;

$$\lambda = \frac{k_B T}{\sqrt{2} \pi d^2 p}$$

where  $d$  is the diameter of the particle and  $p$  is the pressure. which I can easily turn into:

$$\lambda = \frac{m v_{rms}^2}{2 \sqrt{2} \pi d^2 p}$$

**The average distance a particle can travel before colliding with another particle.**

$$\lambda = \frac{1}{n \sigma}$$

**Effect of pressure:**  $\lambda \propto \frac{1}{p}$

Heat or Thermodynamics 10 ) Questions on efficiency of cycle

**Suppose 0.2 mole of an ideal di-atomic gas ( $\gamma = 1.4$ ) undergoes cycle with temperature  $T_H = 400$  K and  $T_C = 300$  K. The initial pressure is  $p_a = 10 \times 10^5$  Pa and during isothermal expansion at temperature  $T_H$  the volume doubles.**

- (i) Find  $Q$ ,  $W$  and  $\Delta U$  from each step in the cycle.
- (ii) Find the efficiency.

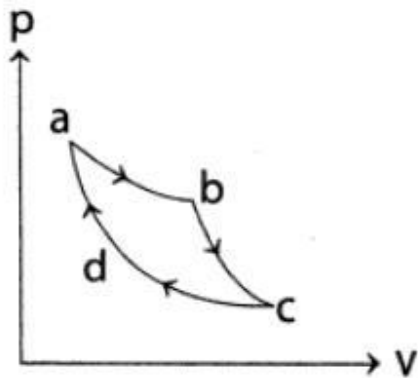

**Solution**

$$(i) \quad V_a = \frac{nRT_H}{p_a} \\ = \frac{0.2 \times 8.314 \times 400}{10 \times 10^5} = 6.65 \times 10^{-4} \text{ m}^3$$

For isothermal expansion  $a \rightarrow b$

$$p_a V_a = p_b V_b$$

$$\text{or } p_h = \frac{P_a V_a}{V_b} = 5 \times 10^5 p_a$$

For adiabatic expansion  $b \rightarrow c$

$$T_H V_b^{\gamma-1} = T_c V_c^{\gamma-1}$$

$$\therefore V_c = V_b \left( \frac{T_H}{T_c} \right)^{\frac{1}{\gamma-1}}$$

$$= 13.3 \times 10^{-4} \times \left( \frac{4}{3} \right)^{2.5} = 27.3 \times 10^{-4} \text{ m}^3$$

$$p_c = \frac{nRT_c}{V_c} = \frac{0.2 \times 8.314 \times 300}{27.3 \times 10^{-4}}$$

$$= 1.83 \times 10^5 \text{ Pa}$$

For adiabatic compression  $d \rightarrow a$

$$T_c V_d^{\gamma-1} = T_H V_a^{\gamma-1}$$

$$V_d = V_a \left( \frac{T_H}{T_c} \right)^{\frac{1}{\gamma-1}} = 6.65 \times 10^{-4} \times \left( \frac{4}{3} \right)^{2.5}$$

$$= 13.65 \times 10^{-4} \quad p_d = \frac{nRT_c}{V_d}$$
$$= \frac{0.2 \times 8.314 \times 300}{13.65 \times 10^{-4}} = 3.65 \times 10^5 \text{ Pa}$$

For isothermal expansion  $a \rightarrow b$

$$\Delta U = 0$$

$$\therefore W = Q_H = nRT_H \cdot \log_e \frac{V_b}{V_a}$$
$$= 0.2 \times 8.314 \times 400 \log_e 2$$
$$= \mathbf{461 \text{ J}}$$

For adiabatic expansion  $b \rightarrow c$

$$Q = 0$$

$$\therefore W = -\Delta U = nC_V(T_H - T_C)$$
$$= 0.2 \times 20.78 \times (400 - 300)$$
$$= \mathbf{415.7 \text{ J}}$$

For isothermal compression  $c \rightarrow d$

$$\Delta U = 0$$

$$\therefore W = Q_c = nRT_c \log_e \frac{V_d}{V_c}$$
$$= 0.2 \times 8.314 \times 300 \log_e \frac{13.65 \times 10^{-4}}{27.3 \times 10^{-4}}$$
$$= \mathbf{-345.8 \text{ J}}$$

For adiabatic expansion  $d \rightarrow a$

$$Q = 0$$

$$\therefore W = -U$$
$$= nC_V(T_C - T_H)$$
$$= 0.2 \times 20.78 \times (300 - 400)$$
$$= \mathbf{-415.7 \text{ J}}$$

The results may be tabulated as follows:

	<b>Q</b>	<b>W</b>	<b><math>\Delta U</math></b>
$a \rightarrow b$	461 J	461 J	0 J
$b \rightarrow c$	0 J	415.7 J	- 415.7 J
$c \rightarrow d$	- 345.8 J	- 345.8 J	0 J
$d \rightarrow a$	0 J	- 415.7 J	415.7 J
<b>Total</b>	<b>115.2 J</b>	<b>115.2 J</b>	<b>0 J</b>

(ii) For entire cycle,  $Q = W$

$$\Delta U = 0$$

$$\text{Total work done} = 115.2 \text{ J}$$

$$Q_H = 461 \text{ J}$$

$$\therefore \eta = \frac{W}{Q_H} = \frac{115.2}{461} = 0.25$$

Efficiency of cycle example

**One mole of a di-atomic ideal gas ( $\gamma = 1.4$ ) is taken through a cyclic process starting from point  $A$ . The process  $A \rightarrow B$  is an adiabatic compression,  $B \rightarrow C$  isobaric expansion,  $C \rightarrow D$  is an adiabatic expansion and  $D \rightarrow A$  isochoric expansion. The volume ratios are  $\frac{V_A}{V_B} = 16$  and  $\frac{V_C}{V_B} = 2$  and the temperature at  $A$  is  $T_A = 300$  K. Calculate the temperature of gas at the points  $B$  and  $D$  and find the efficiency of the cycle.**

**Solution** For an ideal gas undergoing adiabatic expansion or compression, we have

$$TV^{\gamma-1} = \text{Constant}$$

For the expansion at constant pressure, we have

$$\frac{V}{T} = \text{Constant}$$

With this information, temperature of the gas at different stages of the cyclic process may be determined as follows:

(i) Adiabatic compression from A to B

$$T_B V_B^{\gamma-1} = T_A V_A^{\gamma-1}$$

$$\begin{aligned} \text{or } T_B &= \left(\frac{V_A}{V_B}\right)^{\gamma-1} T_A = (16)^{1.4-1} (300) \\ &= (3.03) (300 \text{ K}) = \mathbf{909 \text{ K}} \end{aligned}$$

(ii) Isobaric expansion from B to C

$$\frac{V_C}{T_C} = \frac{V_B}{T_B}$$

$$\text{or } T_C = \left(\frac{V_C}{V_B}\right) T_B = 2(909) = \mathbf{1818 \text{ K}}$$

(iii) Adiabatic expansion from C to D

$$T_D V_D^{\gamma-1} = T_C V_C^{\gamma-1}$$

$$\text{or } T_D = \left(\frac{V_C}{V_D}\right)^{\gamma-1} T_C$$

Since,  $D \rightarrow A$  is isochoric process, therefore

$$V_D = V_A$$



Hence,

$$\begin{aligned}T_D &= \left(\frac{V_C}{V_D}\right)^{\gamma-1} T_C = \left(\frac{V_C}{16 V_B}\right)^{\gamma-1} T_C \\&= \left(\frac{2}{16}\right)^{1.4-1} (1818 \text{ K}) \\&= (0.4353) (1818 \text{ K}) = 791.4 \text{ K}\end{aligned}$$

The given cyclic process is shown in the figure.

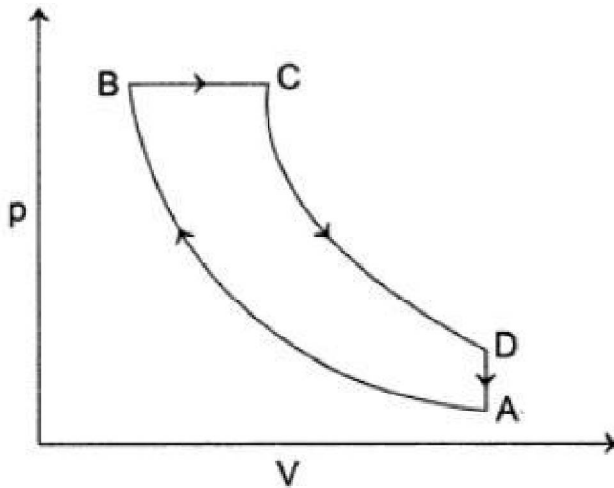

Efficiency of the cycle is defined as

$$\eta = \frac{\text{Work obtained in one cycle}}{\text{Heat absorbed in the process } B \rightarrow C}$$

Now, the work obtained in one cycle is equal to the area within the cycle ABCDA. This

work is given as

$$\begin{aligned}W &= |W_{B \rightarrow C}| + |W_{C \rightarrow D}| + |W_{B \rightarrow A}| \\ &= RT_B + C_V(T_C - T_D) - C_V(T_B - T_A)\end{aligned}$$

For a di-atomic gas,

$$C_V = \frac{5}{2}R \text{ and } C_P = \frac{7}{2}R.$$

Hence,

$$\begin{aligned}W &= R \left[ T_B + \frac{5}{2}(T_C - T_D - T_B - T_A) \right] \\ &= (8.314 \text{ JK}^{-1} \text{ mol}^{-1})\end{aligned}$$

$$\left[ (909 \text{ K}) + \frac{5}{2}(1818 - 791.4 - 909 + 300)\text{K} \right]$$

= 16237.2 Kelvin per mole

Heat absorbed in the process  $B \rightarrow C$  is given as

$$\begin{aligned}Q &= C_P(T_C - T_B) \\ &= \left( \frac{7}{2}R \right)(T_C - T_B) \\ &= \frac{7}{2} \times (8.314 \text{ JK}^{-1} \text{ mole}^{-1}) \\ &\quad (1818 \text{ K} - 909 \text{ K}) \\ &= 26451.0 \text{ J mole}^{-1}\end{aligned}$$

Hence, the efficiency of the cycle is

$$\eta = \frac{W}{Q} = \frac{16237.2}{26451.0} = \mathbf{0.614}$$

Example of Efficiency of a cycle

**An ideal gas is taken through a cycle thermodynamic process through four steps. The amount of heat involved in these steps are  $Q_1 = 5960 \text{ J}$ ,  $Q_2 = -5585 \text{ J}$ ,**

**$Q_3 = -2980 \text{ J}$  and  $Q_4 = 3645 \text{ J}$  respectively. The corresponding worked involved are  $W_1 = 2200 \text{ J}$ ,  $W_2 = -825 \text{ J}$ ,  $W_3 = -1100 \text{ J}$  and  $W_4$  respectively.**

- (i) Find the value of  $W_4$ .
- (ii) What is the efficiency of the cycle?

**Solution** For a cyclic process

$$\Delta U = 0$$

(i) Cyclic  $\int dQ = \int dW$

$$\begin{aligned} \text{i.e., } Q_1 + Q_2 + Q_3 + Q_4 \\ = W_1 + W_2 + W_3 + W_4 \end{aligned}$$

$$\begin{aligned} \text{or } 5960 - 5585 - 2980 + 3645 \\ = 2200 - 825 - 1100 + W_4 \end{aligned}$$

$$\text{or } W_4 = 765 \text{ J}$$

- (ii) Efficiency of the cycle,

$$\eta = \frac{\text{Net work output}}{\text{Total heat input}}$$

$$\begin{aligned} \text{Net work output} &= 5960 - 5585 \\ &\quad - 2980 + 3645 \\ &= 1040 \text{ J} \end{aligned}$$

$$\begin{aligned} \text{Total heat input} &= Q_1 + Q_4 \\ &= 5960 + 3645 = 9605 \text{ J} \end{aligned}$$

$$\therefore \eta = \frac{1040}{9605} \times 100 = 10.83\%$$

Question on Cycle

**2.00 mole of a mono-atomic ideal gas ( $U = 1.5 nRT$ ) is enclosed in an adiabatic, vertical cylinder fitted with a smooth light adiabatic piston. The piston is connected to a vertical spring of spring constant  $200 \text{ N/m}$  as shown in the figure. The area of cross-section of the cylinder is  $20.0 \text{ cm}^2$ . Initially, the spring is at its natural length and the temperature of the gas is  $300 \text{ K}$ . The atmospheric pressure is  $100 \text{ kPa}$ . The gas is heated slowly for some time by means of an electric heater so as to move the piston up through  $10 \text{ cm}$ . Find:**

- (i) **The work done by the gas.**
- (ii) **The final temperature of the gas.**
- (iii) **The heat supplied by the heater.**

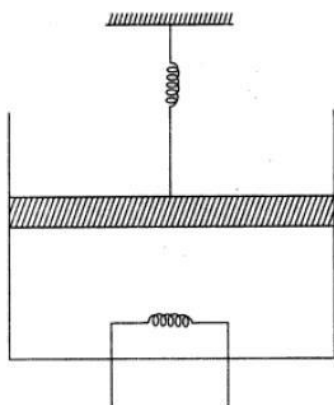

Solution

(i) Force by the gas on the piston is

$$F = p_0 A + kx$$

where,  $P_0 = 100 \text{ kPa}$  is the atmospheric pressure.

$A = 20 \text{ cm}^2$  is the area of the cross-section,

$k = 200 \text{ N/m}$  is the spring constant, and

$x =$  the compression of spring.

Work done by the gas if the piston moves through  $l = 10 \text{ cm}$  is

$$W = \int_0^l F dx$$

$$= P_0 A l + \frac{1}{2} k l^2$$

$$= (100 \times 10^3 \text{ Pa})$$

$$(20 \times 10^{-4} \text{ m}^2) \times (10 \times 10^{-2} \text{ m})$$

$$+ \frac{1}{2} (200 \text{ N/m}) (100 \times 10^{-4} \text{ m}^2)$$

$$= 20 + 1 \text{ J} = \mathbf{21 \text{ J}}$$

(ii) Initial temperature,  $T_1 = 300 \text{ K}$ . Let the final temperature be  $T_2$ , then

$$nRT_1 = p_0 V_0$$

$$nRT = pV_2 = \left( p_0 + \frac{kl}{A} \right) (V_0 + Al)$$

$$= nRT_1 + p_0 Al + kl^2 + \frac{kl nRT_1}{AP_0}$$

$$\text{or } T_2 = T_1 + \frac{p_0 Al + kl^2}{nR} + \frac{k l T_1}{A P_0}$$

$$\begin{aligned} 300 + \frac{20 \text{ J} + 2 \text{ J}}{20 \times 8.3} + \frac{200 \times 10 \times 10^{-2} \times 300}{20 \times 10^{-4} \times 100 \times 10^3 \text{ Pa}} \\ = 300 \text{ K} + 1.325 \text{ K} + 30 \text{ K} \\ = \mathbf{331 \text{ K}} \end{aligned}$$

(iii) Internal energy,  $U = 1.5 nRT$

$$\begin{aligned} \therefore \Delta U &= 1.5 nR\Delta T \\ &= 1.5 \times 2.00 \times 8.3 \times 31 \\ &= 772 \text{ J} \end{aligned}$$

From the first law,

$$\begin{aligned} \Delta Q &= \Delta U + \Delta W \\ &= (772 + 21) \text{ J} = \mathbf{793 \text{ J}} \end{aligned}$$

Example where 2 vessels are connected

**Two vessels contain in each of them one mole of mono-atomic gas. The initial volume of each vessel is  $8.3 \times 10^{-3} \text{ m}^3$ . Equal amount of heat is supplied to each vessel. In one vessel, the volume of gas is doubled without change in its internal energy whereas the volume of the gas is held constant in second vessel. The vessels are now connected to allow free mixing. Find the final temperature and pressure of the combined system.**

**Solution** According to the first law of thermodynamics,

$$\Delta Q = \Delta U + \Delta W$$

For the first vessel:  $\Delta U = 0$ , (Since, no change in temperature)

$$\Delta Q = \Delta W$$

$$Q = \int_{V_1}^{V_2} p dV$$

$$= \int_{V_1}^{V_2} nRT \frac{dV}{V} \quad (\text{since, } pV = nRT)$$

Since  $V_2 = 2 V_1$ , therefore

$$Q = nRT \log_e 2, \quad \dots(i)$$

For the second vessel:  $\Delta W = 0$ , (volume is constant)

$$Q = nC_v \Delta T = n \left( \frac{3}{2} R \right) \Delta T \quad \dots(ii)$$

Since, for mono-atomic gas  $C_v = \frac{3R}{2}$

From equations (i) and (ii), we get

$$nRT \log_e 2 = n \left( \frac{3}{2} R \right) \Delta T$$

$$\text{or } \Delta T = \frac{2}{3} \times 300 \times 0.693 = 138.6 \text{ K}$$

It is the change in temperature of the second vessel.

Now, temperature of the gas in second vessel

$$= T + \Delta T$$

$$= 300 + 138.6 = 438.6 \text{ K}$$

Let after mixing  $T_f$  and  $p_f$  be the final tempera-

ture and pressure, therefore

$$\begin{aligned}T_f &= \frac{T + (T + \Delta T)}{2} \\ &= \frac{300 + 438.6}{2} = 369.3 \text{ K}\end{aligned}$$

From the gas equation,

$$\begin{aligned}p_f V_f &= nRT_f \\ p_f &= \frac{nRT_f}{V_f} \\ &= \frac{2 \times 8.3 \times 369.3}{2 \times 8.3 \times 10^3 + 8.3 \times 10^{-3}} \\ &= 2.46 \times 10^5 \text{ N/m}^2\end{aligned}$$

**A sample of 2 kg of mono-atomic Helium (assumed ideal) is taken through the process ABC and another sample of 2 kg of the same gas is taken through the process ADC. Given relative molecular weight of Helium = 4.**

- (i) **What is the temperature of Helium in each of the states A, B, C and D?**
- (ii) **Is there any way of telling afterwards which sample of Helium went through the process ABC and which went through the process ADC? Write yes or no.**
- (iii) **How much heat is evolved in each of the processes ABC and ADC?**



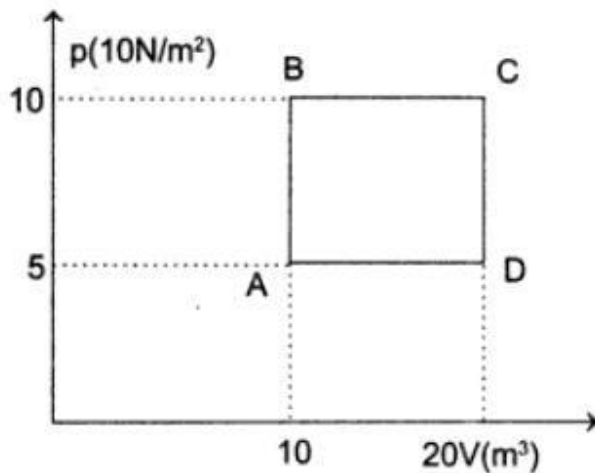

**Solution**

Amount of helium

$$= \frac{m}{M} = \frac{2 \times 10^3}{4 \text{ g mol}^{-1}} = 500 \text{ mole}$$

- (i) The temperature of gas at the states A, B, C and D are

$$\begin{aligned} T_A &= \frac{pV}{nR} \\ &= \frac{(5 \times 10^4 \text{ N/m}^2)(10 \text{ m}^3)}{(500 \text{ mole})(8.314 \text{ JK}^{-1} \text{ mole}^{-1})} \\ &= \mathbf{120.28 \text{ K}} \end{aligned}$$

$$\begin{aligned} T_B &= \frac{(10 \times 10^4 \text{ N/m}^2)(10 \text{ m}^3)}{(500 \text{ mole})(8.314 \text{ JK}^{-1} \text{ mole}^{-1})} \\ &= \mathbf{240.56 \text{ K}} \end{aligned}$$

$$T_c = \frac{(10 \times 10^4 \text{ N/m}^2)(10 \text{ m}^3)}{(500 \text{ mole})(8.314 \text{ JK}^{-1} \text{ mole}^{-1})}$$
$$= 481.12 \text{ K}$$

$$T_D = \frac{(5 \times 10^4 \text{ N/m}^2)(20 \text{ m}^3)}{(500 \text{ mole})(8.314 \text{ JK}^{-1} \text{ mole}^{-1})}$$
$$= 240.50 \text{ K}$$

(ii) No.

(iii) For the process ABC, we have

$$Q_{AB} = nC_V \Delta T$$
$$= (500 \text{ mole}) \left( \frac{3}{2} \times 8.314 \text{ JK}^{-1} \text{ mole}^{-1} \right)$$
$$(240.56 \text{ K} - 120.28 \text{ K})$$
$$= 7.5 \times 10^5 \text{ J}$$

$$Q_{BC} = nC_P \Delta T$$
$$= (500 \text{ mole}) \left( \frac{5}{2} \times 8.314 \text{ JK}^{-1} \text{ mole}^{-1} \right)$$
$$(481.12 \text{ K} - 240.56 \text{ K})$$
$$= 2.5 \times 10^6 \text{ J}$$

$$Q_{ABC} = Q_{AB} + Q_{BC}$$
$$= (7.5 \times 10^5 \text{ J} + 2.5 \times 10^6 \text{ J}) = 3.25 \times 10^6 \text{ J}$$

For the process ADC, we have

$$Q_{AD} = nC_P \Delta T$$
$$= (500 \text{ mole}) \left( \frac{5}{2} \times 8.314 \text{ JK}^{-1} \text{ mole}^{-1} \right)$$
$$(240.56 \text{ K} - 120.28 \text{ K})$$

$$= 1.25 \times 10^6 \text{ J}$$

$$Q_{DC} = nC_V \Delta T$$

$$= (500 \text{ mole}) \left( \frac{3}{2} \times 8.314 \text{ JK}^{-1} \text{ mole}^{-1} \right) \\ (481.12 \text{ K} - 240.56 \text{ K})$$

$$= 1.5 \times 10^6 \text{ J}$$

$$Q_{ADC} = Q_{AD} + Q_{DC}$$

$$= (1.25 \times 10^6 \text{ J} + 1.5 \times 10^6 \text{ J})$$

$$= 2.75 \times 10^6 \text{ J}$$

More example in Heat and Thermodynamics

**A 1.00 mole sample of an ideal mono-atomic gas originally at a pressure of 1.00 atmosphere undergoes a three-step process:**

- (i) **It is expanded adiabatically from  $T_1 = 550 \text{ K}$  and  $T_2 = 389 \text{ K}$ .**
- (ii) **It is compressed at constant pressure until its temperature reaches  $T_3$ .**
- (iii) **It then returns to its original pressure and temperature by a constant-volume process.**
  - (a) Plot these processes on a  $p$ - $V$  diagram.
  - (b) Determine  $T_3$ .
  - (c) Calculate the change in integral

energy the workdone by the gas,  
and heat added to gas for each process.

(d) For the complete cycle.

**Solution** *First step Adiabatic Expansion*

$$Q_1 = 0$$

$$\begin{aligned} W_1 &= n_1 C_v (T_2 - T_1) \\ &= (1.00 \text{ mol}) \left( \frac{3}{2} \times 8.314 \text{ JK}^{-1} \text{ mole}^{-1} \right) \\ &\quad \times (389 \text{ K} - 550 \text{ K}) \\ &= -2007.8 \text{ J} \end{aligned}$$

For adiabatic expansion of an ideal gas

$$p_2 T_2^{(-C_p/R)_g} = p_1 T_1^{(-C_p/R)_g}$$

$$\begin{aligned} \text{Hence, } p_2 &= p_1 \left( \frac{T_1}{T_2} \right)^{\frac{C_p}{R}} = (1.00 \text{ atm}) \left( \frac{389}{550} \right)^{\frac{5}{2}} \\ &= 0.421 \text{ atm.} \end{aligned}$$

$$\begin{aligned} V_2 &= \frac{nRT_2}{p_2} \\ &= \frac{(1.0 \text{ mole})(8.314 \text{ JK}^{-1} \text{ mole}^{-1})(550 \text{ K})}{(1.0 \times 101.325 \text{ KP}_a)} \\ &= 45.1 \text{ dm}^3 \end{aligned}$$

$$\Delta U_1 = W_1 = -2007.8 \text{ J}$$

*Second step compression at constant pressure:*

The final volume in this process will be  $V_1$  as in the third step, the system returns to the original state by constant volume process. Hence, in the second step,

$$T_2 = (389 \text{ K}) \text{ changes to } T_3$$

$$V_2 = (75.8 \text{ dm}^3) \text{ changes to } V_1 \\ = 45.1 \text{ dm}^3$$

$$p_2 = \text{remains constant.}$$

Workdone in the process

$$W_2 = -p_2 (V_1 - V_2) \\ = -(0.421 \times 101.325 \text{ kPa}) (45.1 \text{ dm}^3 - 75.8 \text{ dm}^3) \\ = 1309.6 \text{ J}$$

$$T_3 = \left( \frac{V_1}{V_2} \right) T_2 = \left( \frac{45.1}{75.8} \right) (389 \text{ K}) = 231.4 \text{ K}$$

$$Q_2 = n C_p (T_3 - T_2)$$

$$= \left( \frac{5}{2} \times 8.314 \text{ JK}^{-1} \right) (231.4 \text{ K} - 389 \text{ K})$$

$$= -3275.7 \text{ J}$$

$$\Delta U_2 = Q_2 + W_2$$

$$= -3275.7 \text{ J} + 1309.6 \text{ J} = -1966.1 \text{ J}$$

*Third step compression at constant volume in this process:*

$$W_3 = 0$$

$$V_1 = (45.1 \text{ dm}^3) \text{ remains constant}$$

$$Q_3 = n C_v (T_1 - T_3)$$

$$= \left( \frac{3}{2} \times 8.314 \text{ JK}^{-1} \right) (550 \text{ K} - 231.4 \text{ K})$$

$$\Delta U = 3973.3 \text{ J}$$

Since, the system return to its original state, we will have

$$\Delta U = Q + W = 0$$

$$\begin{aligned} \text{Now, } W &= W_1 + W_2 + W_3 \\ &= -2007.8 \text{ J} + 1309.6 \text{ J} + 0 \\ &= -698.2 \text{ J} \end{aligned}$$

$$\therefore Q = -W = 698.6 \text{ J}$$

The  $p$ - $V$  plot of the given process is shown in the figure:

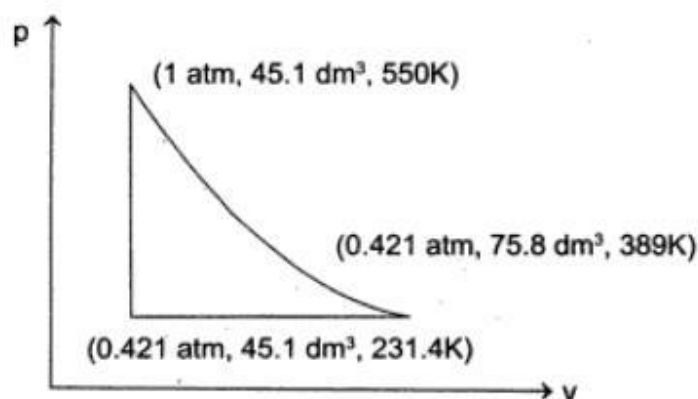

In the complete cycle

$$\Delta U = 0$$

$$\begin{aligned} Q &= Q_1 + Q_2 + Q_3 \\ &= 0 - 3275.7 \text{ J} + 3973.3 \text{ J} = 697.6 \text{ J} \end{aligned}$$

$$\begin{aligned} W &= -Q = 697.6 \text{ J} (= W_1 + W_2 + W_3) \\ &= -2007.8 + 1309.6 \text{ J} + 0 = 698.2 \text{ J} \end{aligned}$$

**Two mole of an ideal mono-atomic gas is taken through a cycle  $ABCA$  as shown in the  $p - T$  diagram. During this process  $AB$ , pressure and temperature of the gas vary such that  $pT = \text{constant}$ . If  $T_1 = 300$  K, calculate:**

- (i) **The work done on the gas in the process  $AB$ .**
- (ii) **The heat absorbed or released by the gas in each of the process.**

Give answers in terms of the gas constant  $R$ .

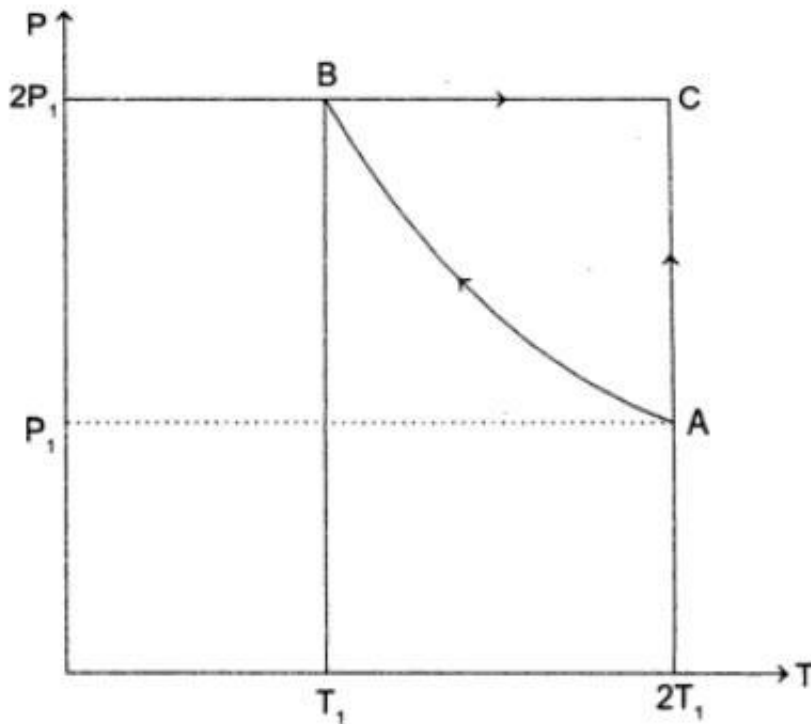

**Solution** The volumes of the gas at three states A, B and C are as follows:

$$V_A = \frac{nRT_A}{P_A} = \frac{nR(2T_1)}{P_1} = \frac{2nRT_1}{P_1} \dots(i)$$

$$V_B = \frac{nRT_B}{P_B} = \frac{nR(2T_1)}{P_1} = \frac{1}{2} \frac{nRT_1}{P_1} \dots(ii)$$

$$V_C = \frac{nRT_C}{P_C} = \frac{nR(2T_1)}{2P_1} = \frac{nRT_1}{P_1} \dots(iii)$$

It is given that during the process AB,

$$pT = K \dots(iv)$$

where, K is constant and is given as

$$K = p_A T_A = (p_1) (2T_1) = 2 p_1 T_1 \dots(v)$$

In the process AB, we will have

$$= \sqrt{nRK} \left[ 2\sqrt{V_B} - 2\sqrt{V_A} \right]$$

Using equations (i), (ii) and (v), we get

$$\begin{aligned} W_{AB} &= \sqrt{nR(2p_1T_1)} \left[ 2\sqrt{\frac{nRT_1}{2p_1}} - 2\sqrt{\frac{2nRT_1}{p_1}} \right] \\ &= (\sqrt{2} nRT_1)(2) \left[ \frac{1}{2} - \sqrt{2} \right] \\ &= -2n T_1 R \\ &= -2 (2 \text{ mole}) (200 \text{ K}) R \\ &= - (1200 \text{ mole K}) R \end{aligned}$$

The negative sign implies that the work is done on the gas.

Hence, work done on the gas  
= **(1200 mole K) R**



(ii) Change in energy of the gas in the process AB is

$$\begin{aligned}\Delta U_{AB} &= nC_v \Delta T \\ &= (2 \text{ mole}) \left( \frac{3}{2} R \right) (T_1 - 2 T_1) \\ &= - (3 \text{ mole}) T_1 R \\ &= - (3 \text{ mole}) (300 \text{ K}) R \\ &= - (900 \text{ mole K}) R\end{aligned}$$

Now, from the first law of thermodynamics,

$$\begin{aligned}Q_{AB} &= \Delta U_{AB} + W_{AB} \\ &= - (1200 \text{ mole K}) R \\ &= - (900 \text{ mole K}) R \\ &= - (2100 \text{ mole K}) R\end{aligned}$$

The negative sign implies that the heat is released in the process AB. The process

BC takes place at constant pressure.

Hence,

$$\begin{aligned}W_{BC} &= p V \\ &= (2 p_1) (V_C - V_B) \\ &= (2 p_1) \left[ \frac{nRT_1}{P_1} - \frac{nRT_1}{2 P_1} \right] \\ &= nRT_1 \\ &= (2 \text{ mole}) (300 \text{ K}) R \\ &= (600 \text{ mole K}) R\end{aligned}$$

Now,  $\Delta U_{BC} = nC_v \Delta T$

$$= (2 \text{ mole}) \left( \frac{3}{2} R \right) (T_C - T_B)$$

$$\begin{aligned} &= (3 \text{ mole}) (R) (2 T_1 - T_1) \\ &= (3 \text{ mole}) (R) (300 \text{ K}) \\ &= (900 \text{ mole K}) R \\ Q_{BC} &= \Delta U_{BC} + W_{BC} \\ &= (900 \text{ mole K}) R + (600 \text{ mole K}) R \\ &= \mathbf{(1500 \text{ mole K}) R} \end{aligned}$$

The positive sign implies that the heat is absorbed in the process BC.

The process CA takes place at constant temperature. Hence,

$$\begin{aligned} W_{CA} &= \int_{V_A}^{V_B} p dV \\ &= \int_{V_A}^{V_B} \frac{nRT}{V} dV \\ &= nRT \ln \frac{V_A}{V_C} \dots \text{(where, } T = 2 T_1) \\ &= (2 \text{ mole}) (R) (2 \times 300 \text{ K}) \ln 2 \\ &= (1200 \text{ mole K}) R \ln 2 \end{aligned}$$

$$\begin{aligned} \Delta U_{CA} &= 0 \\ Q_{CA} &= \Delta U_{CA} + W_{CA} \\ &= 0 + (1200 \text{ mole K}) R \ln 2 \end{aligned}$$

The positive sign implies that the heat is absorbed in the process CA.

**An ideal mono-atomic gas is confined in a cylinder by a spring-loaded piston of cross-section  $8 \times 10^{-3} \text{ m}^2$ . Initially, the gas is at 300 K and occupies a volume of  $2.4 \times 10^{-3} \text{ m}^3$  and the spring is on its relaxed (unstretched, uncompressed) state as shown in the figure. The gas is heated by a small electric heater until the piston moves out slowly by 0.1 m. Calculate the final temperature of the gas and the heat supplied (in joules) by the heater. The force constant of the spring is  $8000 \text{ Nm}^{-1}$  and atmospheric pressure is  $1 \times 10^5 \text{ Nm}^{-2}$ . The cylinder and the piston are thermally insulated. The piston is massless and there is no friction between the piston and cylinder. Neglect heat loss through the lead wires of the heater. The heat capacity of the heater coil is negligible. [Assume the spring to be massless].**

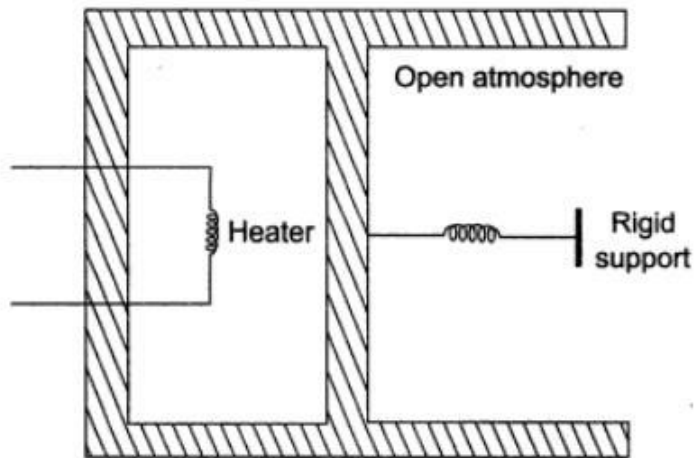

**Solution** Let  $p_0$  be the atmospheric pressure. Initially for the equilibrium of the piston,  $p_L = p_R = p_0$  where  $p_L$  and  $p_R$  are the pressures on the left hand and right hand side of the piston.

Force exerted by the spring on the piston when it moves

$$F = kx = 8000 \times 0.1 \\ = 800 \text{ N}$$

$\therefore$  Pressure exerted on the piston by the spring

$$p_s = \frac{F}{A} = \frac{800 \text{ N}}{8 \times 10^{-3} \text{ m}^2} = 1 \times 10^5 \text{ Nm}^{-2}$$

$\therefore$  Total pressure acting on the right hand side

$$p'_R = p_0 + p_s \\ = 2 \times 10^5 \text{ N/m}^2$$

Under equilibrium  $p'_L = p'_R$

$$\begin{aligned}\text{or } \frac{p_L V_L}{T_L} &= \frac{p'_L V'_L}{T'_L} \\ &= \frac{1 \times 10^5 \times 2.4 \times 10^{-3}}{300} \\ &= \frac{2 \times 10^5 \times 3.2 \times 10^{-3}}{T'_L}\end{aligned}$$

$$T'_L = 800 \text{ K}$$

$$\Delta U = n C_v \Delta T$$

$$\begin{aligned}\text{where, } n &= \frac{p_L V_L}{R T_L} = \frac{1 \times 10^5 \times 2.4 \times 10^{-3}}{8.3 \times 300} \\ &= 0.09638 \text{ mole}\end{aligned}$$

$$\therefore \Delta U = 0.09638 \times \frac{3}{2} \times 8.3 \times (800 - 300) = 600 \text{ J}$$

$$\begin{aligned}\Delta W &= \frac{1}{2} k \cdot x^2 + p_0 \cdot \Delta V \\ &= \frac{1}{2} \times 800 \times (0.1)^2 + 1 \times 10^5 \times 8 \times 10^{-4} \\ &= 120 \text{ J}\end{aligned}$$

$$\Delta Q = \Delta U + \Delta W = 600 + 120 = \mathbf{720 \text{ J.}}$$

**A system is taken from state  $i$  to the state  $f$  (refer to the figure). Along path “ $iaf$ ”, it is found that  $\Delta Q = 50$  cal.  $\Delta W = 20$  cal. Along the path “ $ibf$ ”,  $\Delta Q = 36$  cal. Calculate:**

- (i)  $\Delta W$  along the path “ $ibf$ ”.
- (ii) If  $\Delta W = -13$  cal for the curved path “ $fi$ ”, what is the  $\Delta Q$  for this path?
- (iii) Taking  $U_i = 10$  cal, what is  $U_f$ ?
- (iv) If  $U_b = 22$  cal, what is  $\Delta Q$  for the process “ $ib$ ” and the process “ $bf$ ”?

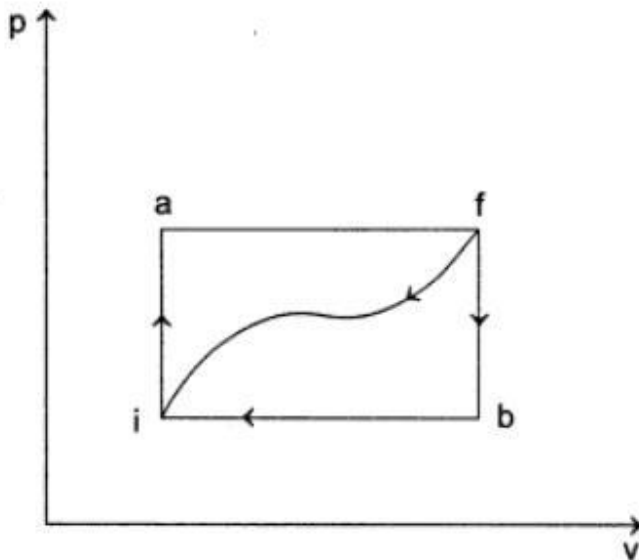

**Solution** Path "iaf"  $\Delta Q = 50 \text{ cal}$

$$\Delta W = 20 \text{ cal}$$

$$\Rightarrow \Delta U = \Delta Q - \Delta W \\ = 50 - 20 = 30 \text{ cal}$$

$$\Rightarrow U_f - U_i = 30 \text{ cal}$$

As internal energy change is a state function.

$\Delta U$  will be same for any path from  $i$  to  $f$ .

$$\begin{aligned} \text{(i) Path "ibf"} \Delta W &= \Delta Q - \Delta U \\ &= 36 - (U_f - U_i) \\ &= 36 - 30 = \mathbf{6 \text{ cal.}} \end{aligned}$$

$$\begin{aligned} \text{(ii) Path "fi"} \Delta Q &= \Delta U + \Delta W \\ &= (U_f - U_i) + \Delta W \\ &= (-30) + (-13) \\ &= \mathbf{-43 \text{ cal}} \end{aligned}$$

$$\begin{aligned} \text{(iii) } U_f - U_i &= 30 \text{ cal} \\ U_f &= U_i + 30 \quad \therefore = \mathbf{40 \text{ cal.}} \end{aligned}$$

$$\begin{aligned} \text{(iv) Process "ib"} \Delta Q &= \Delta U + \Delta W \\ &= (U_b - U_i) + (\Delta W)_{ibf} \end{aligned}$$

$$(\Delta W)_{ib} = (\Delta W)_{ibf}$$

Because  $(\Delta W)_{bf} = 0$

$$\begin{aligned} \Delta Q &= (22 - 10) + 6 \\ &= \mathbf{18 \text{ cal.}} \end{aligned}$$

$$\begin{aligned} \text{Process "bf"} \Delta Q &= \Delta U + \Delta W \\ &= (U_f - U_b) + 0 \\ &= (40 - 22) \\ &= \mathbf{18 \text{ cal.}} \end{aligned}$$

**A mono-atomic ideal gas of two moles is taken through a cyclic process starting from A as shown in the figure. The**

**volume ratios are  $\frac{V_B}{V_A} = 2$  and  $\frac{V_D}{V_A} = 4$ .**

**If the temperature  $T_A$  at A is  $27^\circ\text{C}$ , calculate:**

- (i) **The temperature of the gas at point B.**
- (ii) **Heat absorbed or released by the gas in each process.**
- (iii) **The total work done by the gas during complete cycle.**

**Express your answer in terms of the gas constant  $R$ .**

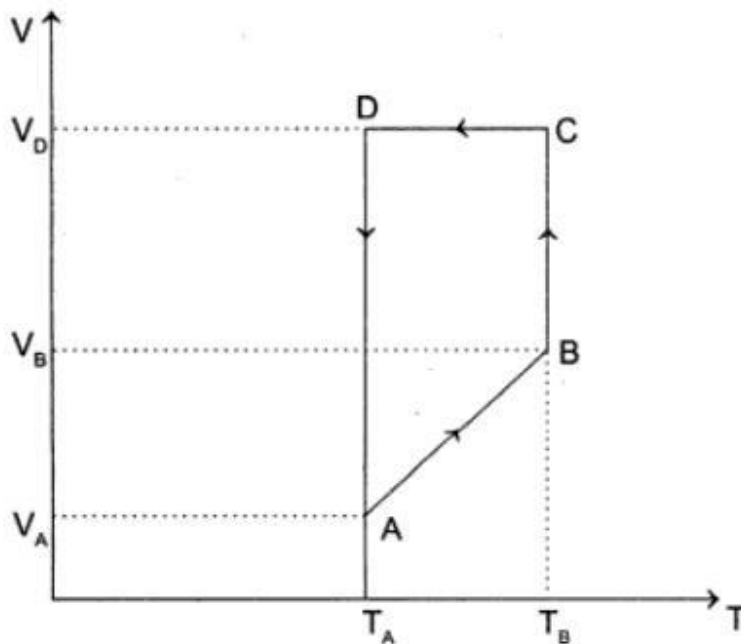

### **Solution**

Given:  $\frac{V_B}{V_A} = 2$  and  $\frac{V_D}{V_A} = 4$

$$T_A = 27^\circ\text{C}$$



- (i) The process  $A \rightarrow B$  in which the plot of  $V$  verse  $T$  is linear occurs at constant pressure condition.

$$\text{Hence } \frac{V_A}{T_A} = \frac{V_B}{T_B}$$

$$\text{or } T_B = \left( \frac{V_B}{V_A} \right) T_A = (2)(300 \text{ K}) \\ = \mathbf{600 \text{ K}}$$

- (ii) The process  $A \rightarrow B$  occurs at constant pressure. Hence,

$$Q_{A \rightarrow B} = n C_p (T_B - T_A) \\ = (2 \text{ mole}) \left( \frac{5}{2} R \right) (600 \text{ K} - 300 \text{ K}) \\ = (1500 \text{ mole K}) R.$$

The process  $B \rightarrow C$  occurs at constant temperature. From first law of thermodynamics

$$dU = dQ - dW$$

Since, the internal energy of an ideal gas depends only on temperature, therefore

$$dU = 0 \text{ and } dQ = dW$$

$$Q_{B \rightarrow C} = W_{B \rightarrow C}$$

$$= \int p dV = nRT_B \int \frac{dV}{V}$$

$$= nR T_B \ln \frac{V_C}{V_B}$$

$$= nR T_B \ln \frac{V_D}{V_B} \dots \dots (\text{as } V_C = V_D)$$

$$\begin{aligned}
 &= nR T_B \ln\left(\frac{V_D}{V_A} \frac{V_A}{V_B}\right) \\
 &= (2 \text{ mole}) (R) (600 \text{ K}) \ln\left(\frac{4}{2}\right) \\
 &= (1200 \text{ mole K}) R \ln 2
 \end{aligned}$$

The process C  $\rightarrow$  D occurs at constant volume. Hence,

$$\begin{aligned}
 Q_{C \rightarrow D} &= nC_v (T_A - T_B) \\
 &= (2 \text{ mole}) \left(\frac{3}{2}R\right) (300 \text{ K} - 600 \text{ K}) \\
 &= - (900 \text{ mole K}) R
 \end{aligned}$$

The process D  $\rightarrow$  A occurs at constant temperature. Hence,

$$\begin{aligned}
 Q_{D \rightarrow A} &= W_{D \rightarrow A} = nRT_A \ln \frac{V_A}{V_D} \\
 &= (2 \text{ mole}) (R) (300 \text{ K}) \ln\left(\frac{1}{4}\right) \\
 &= - (1200 \text{ mole K}) R \ln 2.
 \end{aligned}$$

(iii) Since, the process ABCDA is a cyclic process, therefore

$$U = 0, W = Q$$

where,

$$\begin{aligned}
 Q &= Q_{A \rightarrow B} + Q_{B \rightarrow C} + Q_{C \rightarrow D} + Q_{D \rightarrow A} \\
 &= (1500 \text{ mole K}) R + (1200 \text{ mole K}) R \ln 2 - (900 \text{ mole K}) \\
 &\quad R - (1200 \text{ mole K}) R \ln 2 \\
 &= (600 \text{ mole K}) R.
 \end{aligned}$$

**An ideal gas expands from a volume  $V_0 = 1$  litre and pressure  $p_0 = 1$  bar to volume 3 litre along two different paths  $ABC$  and  $AC$  as shown in figure. The heat added to the gas along the path  $ABC$  is 600 J.**

- (i) Sketch the process on  $p - T$  diagram.
- (ii) Find the work done by the gas along the paths  $ABC$  and  $AC$ .
- (iii) Find the heat transfer in the process along the path  $AC$ .

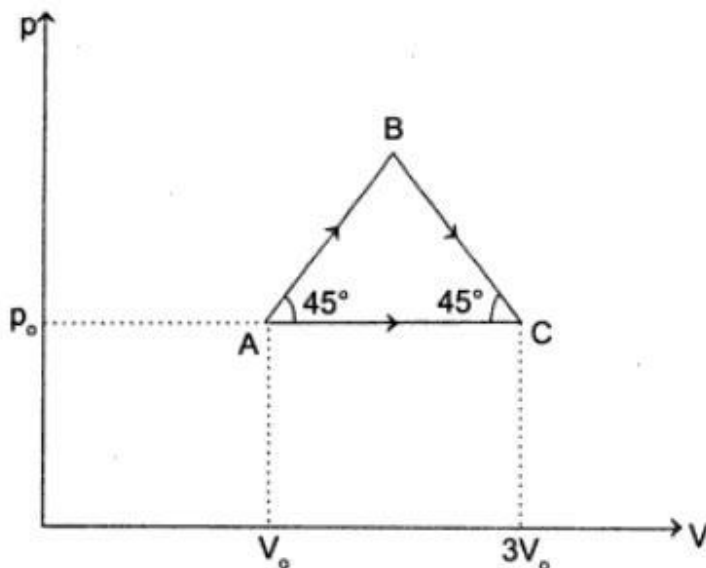

**Solution**

- (i) Equation of line AB,

$$p - p_0 = \tan 45^\circ (V - V_0)$$

Hence for ideal gas,  $p = V$

Now  $pV = KT$

$$\Rightarrow p^2 = KT \text{ (parabola)}$$

.....(where K is constant.)

At B  $V_B = 2 V_0$  and  $p_B = 2 p_0$   
Equation of line BC,  $p - 2 p_0 = -\tan 45^\circ$   
( $V - 2 V_0$ )

$$\therefore p = -V + 4$$

$$\Rightarrow p = -\frac{KT}{P} + 4$$

$$\therefore P^2 - 4p = -KT \text{ (Parabola)}$$

(ii) Workdone along path AC =  $(\Delta W)_{AC}$   
 $= p_0 (3 V_0 - V_0)$   
 $= 2 p_0 V_0$   
 $= 2 \times 1 \times 10^5 \times 1 \times 10^{-3}$   
 $= \mathbf{200 \text{ J.}}$

(iii) For path ABC  $(\Delta Q)_{ABC} = (\Delta U)_{AC} + (\Delta W)_{ABC}$   
 $\Rightarrow (\Delta U)_{AC} = 600 - 300$   
 $= 300 \text{ J.}$

Heat transfer in the process along path AC,

$$(Q)_{AC} = (\Delta U)_{AC} + (\Delta W)_{AC}$$
$$= 300 + 200 = \mathbf{500 \text{ J.}}$$

Gravitation by Prof. Subhashish Chattopadhyay SKMClasses Bangalore Useful for IIT-JEE, CBSE, I.Sc. PU-II, Boards, CET, CEE, PET, IGCSE IB AP-Physics and other exams

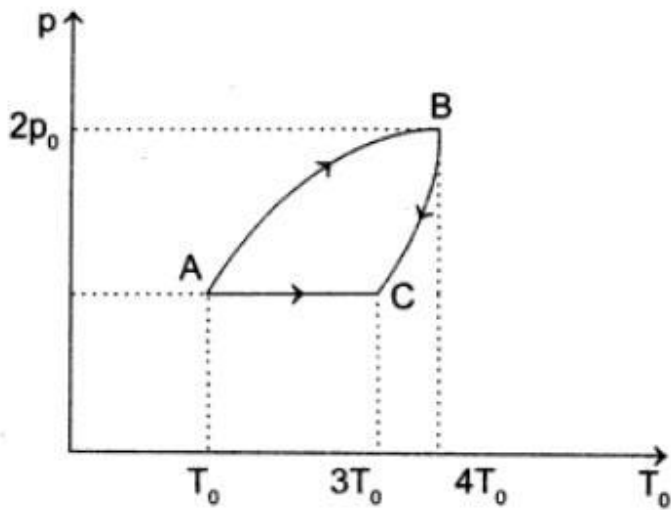
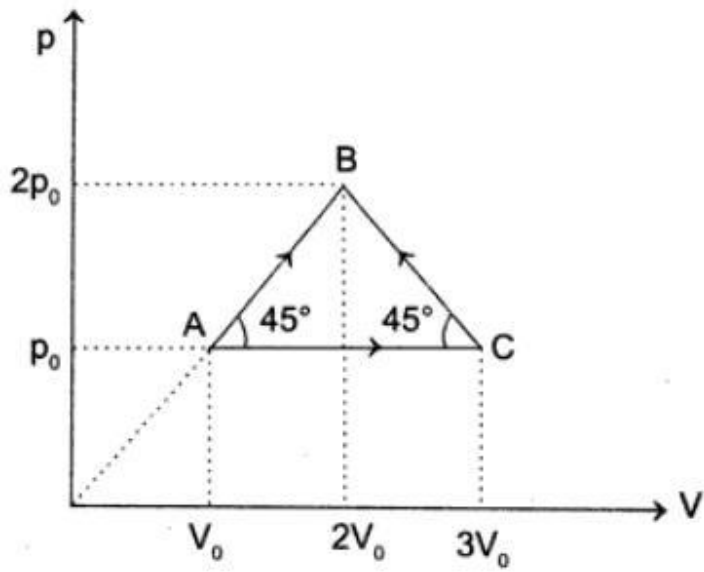

Gravitation by Prof. Subhashish Chattopadhyay SKMClasses Bangalore Useful for IIT-JEE, CBSE, I.Sc. PU-II, Boards, CET, CEE, PET, IGCSE IB AP-Physics and other exams

**A monatomic ideal gas, initially at temperature  $T_1$  is enclosed in a cylinder fitted with a frictionless piston. The gas is allowed to expand adiabatically to a temperature  $T_2$  by releasing the piston suddenly. If  $L_1$  and  $L_2$  are the lengths of the gas column before and after expansion respectively, then  $T_1/T_2$  is given by**

(a)  $\left(\frac{L_1}{L_2}\right)^{2/3}$

(b)  $\frac{L_1}{L_2}$

(c)  $\frac{L_2}{L_1}$

(d)  $\left(\frac{L_2}{L_1}\right)^{2/3}$

$$TV^{\gamma-1} = \text{constant}$$

For monatomic gas  $\gamma = \frac{5}{3}$

$$\Rightarrow TV^{2/3} = \text{constant}$$

Since volume is proportional to length, therefore,

$$\frac{T_1}{T_2} = \left(\frac{L_2}{L_1}\right)^{2/3}$$

Hence (d) is correct.

**Two identical containers  $A$  and  $B$  with frictionless pistons contain the same ideal gas at the same temperature and the same volume  $V$ . The mass of gas contained in  $A$  is  $m_A$  and that in  $B$  is  $m_B$ . The gas in each cylinder is now allowed to expand isothermally to the same final volume  $2V$ . The change in the pressure in  $A$  and  $B$  are found to be  $\Delta p$  and  $1.5 \Delta p$  respectively. Then**

- (a)  $4m_A = 9m_B$                       (b)  $2m_A = 3m_B$   
(c)  $3m_A = 2m_B$                       (d)  $9m_A = 4m_B$

$$\text{For gas in A, } p_1 = \left(\frac{m_A}{M}\right) \frac{RT}{V_1}$$

$$p_2 = \left(\frac{m_A}{M}\right) \frac{RT}{V_2}$$

$$\therefore \Delta p = p_2 - p_1 = \left(\frac{RT}{M}\right) m_A \left(\frac{1}{V_1} - \frac{1}{V_2}\right)$$

Putting  $V_1 = V$  and  $V_2 = 2V$ , we get

$$\Delta p = \left(\frac{RT}{M}\right) \frac{m_A}{2V}$$

$$\text{Similarly for Gas in B, } 1.5 \Delta p = \left(\frac{RT}{M}\right) \frac{m_B}{2V}$$

From equation (i) and (ii) we get

$$2m_B = 3m_A$$

Hence (c) is the correct.

**Two insulating cylinders  $A$  and  $B$  fitted with pistons contain equal amounts of an ideal diatomic gas at temperature  $300\text{ K}$ . The piston  $A$  is free to move, while that of  $B$  is held fixed. The same amount of heat is given to the gas in each cylinder. If the rise in temperature of the gas in  $A$  is  $30\text{ K}$ . Then the rise in temperature of the gas in  $B$  is**

- (a)  $30\text{ K}$                       (b)  $18\text{ K}$   
(c)  $50\text{ K}$                       (d)  $42\text{ K}$

For cylinder A    For cylinder B

$$dQ = n C_p dT_1 \quad dQ = n C_V dT_2$$
$$= n (C_V + R) dT_1$$

$$\therefore n C_V dT_2 = n (C_V + R) 30$$

$$\therefore dT_2 = \frac{(C_V + R) 30}{C_V}$$

For diatomic gas  $C_V = \frac{5}{2}R$

$$\therefore dT_2 = 42\text{ K}$$

Hence (d) is correct.



**Which of the following graph correctly represents the variation of**

$$\hat{a} = -\left(\frac{dV}{dP}\right)/V \text{ with } p \text{ for an ideal gas}$$

**at constant temperature?**

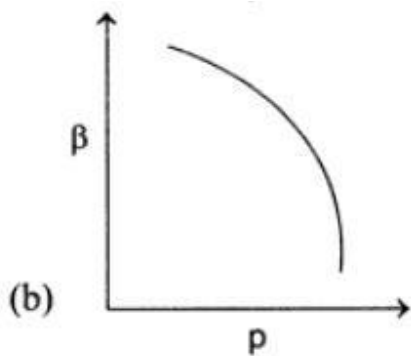
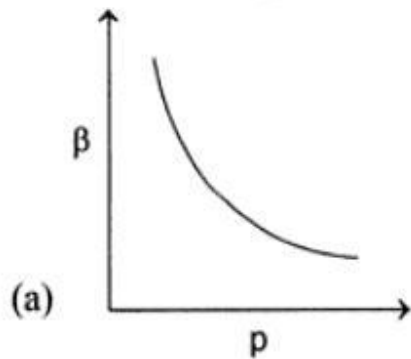

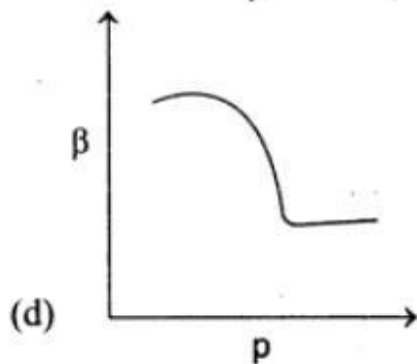
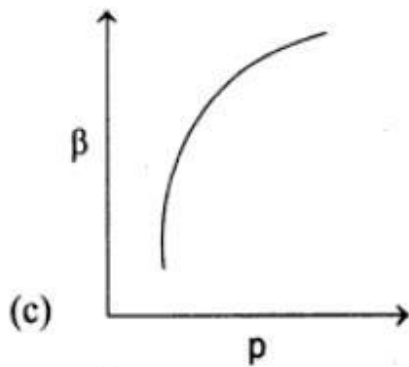

As temperature is constant,

$$pV = \text{constant}$$

$$\Rightarrow pdV + Vdp = 0$$

$$\Rightarrow -\frac{(dV/dp)}{V} = \frac{1}{p}$$

$$\Rightarrow \beta = \frac{1}{p}$$

**An ideal gas is taken through the cycle  $A \rightarrow B \rightarrow C \rightarrow A$ , as shown in the gas in the cycle is 5J, the work done by the gas in the process  $C \rightarrow A$  is**

- (a)  $-5J$                       (b)  $-10J$   
(c)  $-15J$                       (d)  $-20J$

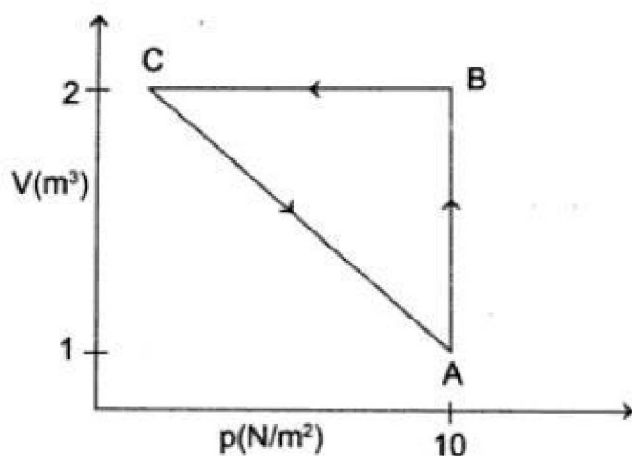

For the cyclic process  $\Delta U = 0$

$$\begin{aligned}\Delta W &= W_{AB} + W_{BC} + W_{CA} \\ &= (10 + 0 + W_{CA}) J\end{aligned}$$

Given:  $\Delta Q = 5J$

From first law of thermodynamics

$$\begin{aligned}5 &= 10 + 0 + W_{CA} \\ \Rightarrow W_{CA} &= -5J\end{aligned}$$

Properties of Material 1 ) Torsional Torque per unit twist

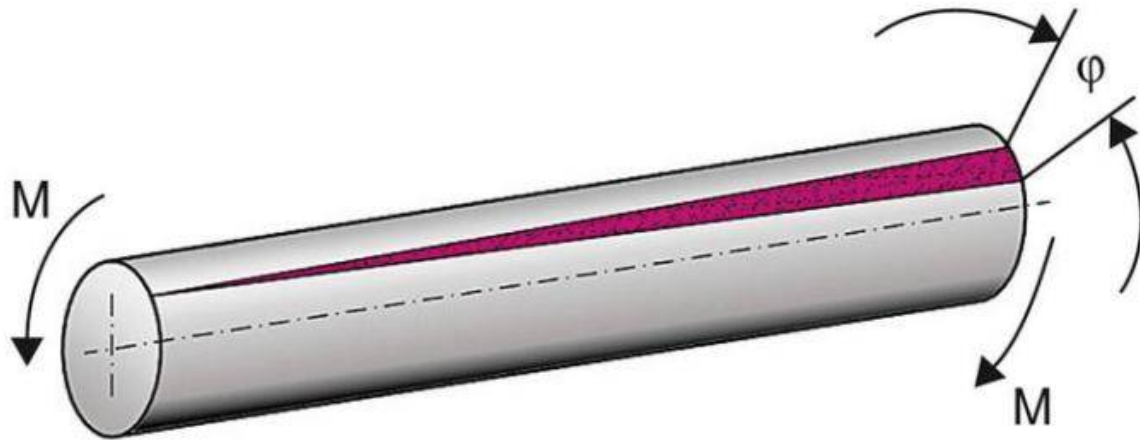

The torque  $T$  can be equated to the sum of the moments of the tangential stresses on the element  $2\pi r \delta r$ .

$$\therefore T = \int s (2\pi r dr) r$$

$$T = \int \frac{C\theta}{l} (2\pi r^3) dr$$

$$= \frac{C\theta}{l} \pi \frac{r^4}{2}$$

Properties of Material 2 ) Torsion of a cylinder

### TORSION OF A CYLINDER/TWISTING OF WIRE

Let,  $l$  = length of cylinder

$r$  = radius of cylinder

$\phi$  = angle of twist

$\theta$  = angle of shear

$\eta$  = modulus of rigidity

$\tau$  = restoring torque developed in the cylinder twisting

$c$  = restoring couple per unit twist

$F$  = tangential force applied at the free end.

(i) Relation between angles of shear and twist

$$BB' = l\theta = r\phi \text{ or}$$

$$\theta = \frac{r}{l} \phi$$

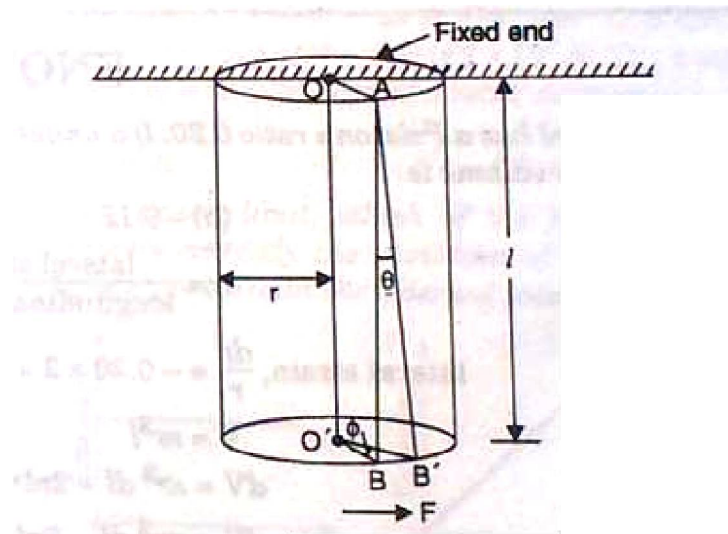

$$(ii) \tau = \frac{\pi \eta r^4}{2l} \phi$$

$$\tau = c\phi$$

(iii) Work done in twisting through angle  $\phi$  is

$$\frac{1}{2} c\phi^2, \text{ i.e., } \frac{\pi \eta r^4}{4l} \phi^2$$

Properties of Material 3 ) Coefficient of Resilience

3 kinds of Coefficient of Resilience

The amount of energy absorbed per unit volume of the body. This is affected by the class of deformation whether axial, bending, or torsional; hence there are three kinds of coefficients of resilience.

Some Authors refer Coefficient of Restitution as Coefficient of resilience.

If a ball falls from a height falling vertically, and just before hitting the ground, it has a speed of  $v_1$ . Then after hitting the ground it jumps upward with a vertical upward speed of  $v_2$ .

Then the coefficient of restitution  $e = \text{mod of } (v_2 / v_1)$

If a ball is moving at  $u_1$  and another is moving at  $u_2$ , they collide. After collision if these move at  $v_1$  and  $v_2$  then  $e = \text{mod of } (v_2 - v_1) / (u_2 - u_1)$

Gravitation by Prof. Subhashish Chattopadhyay SKMClasses Bangalore Useful for IIT-JEE, CBSE, I.Sc. PU-II, Boards, CET, CEE, PET, IGCSE IB AP-Physics and other exams

$$e = \frac{\text{Velocity of Separation}}{\text{Velocity of approach}}$$

$$\text{ie. } e = \frac{V_2 - V_1}{U_2 - U_1} \quad \dots(2)$$

Properties of Material 4 ) Relations between various Elastic constants

## RELATIONS CONNECTING THE ELASTIC CONSTANTS

$$1. K = \frac{Y}{3(1 - 2\sigma)} \quad 3. \frac{9}{Y} = \frac{3}{\eta} + \frac{1}{K}$$

$$2. \eta = \frac{Y}{2(1 + \sigma)} \quad 4. \sigma = \frac{3K - 2\eta}{2(3K + \eta)}$$

Write many times to memorize

### Relations between Elastic Constants $Y$ , $\eta$ , $K$ and $\sigma$

$$(i) \eta = \frac{Y}{2(1 + \sigma)} \quad (ii) K = \frac{Y}{3(1 - 2\sigma)}$$

$$(iii) \frac{3}{Y} = \frac{1}{3K} + \frac{1}{\eta} \quad (iv) \sigma = \frac{3K - 2\eta}{2\eta + 6K}$$

There is a mistake in the formula below.  $Y/\eta$  should be  $2(1 + \sigma)$

$$\text{Note } \beta = \frac{Y}{3(1 - 2\sigma)}, \frac{Y}{\eta} = 2(1 + \sigma), Y = \frac{\sigma\eta\beta}{\eta + 3\beta},$$

$$\text{Torsional rigidity } C = \frac{k\eta r^4}{2l}$$

Torsional couple (Torque)  $G = C\theta$ . If tangential stress is  $T$  then  $\frac{T}{r} = \eta$  where  $\phi$  is shear angle.  $\phi =$

$$\frac{x\theta}{l} \text{ where } \theta \text{ is angle of twist.}$$

Gravitation by Prof. Subhashish Chattopadhyay SKMClasses Bangalore Useful for IIT-JEE, CBSE, I.Sc. PU-II, Boards, CET, CEE, PET, IGCSE IB AP-Physics and other exams

Poisson's ratio cannot exceed

- (a) 0.25 (b) 1.0  
(c) 0.75 (d) 0.5

(d)  $B = \frac{Y}{3(1-2\sigma)}$  if  $B = \infty$   $1 - 2\sigma \rightarrow 0$  or  
 $\sigma_{\max} = \frac{1}{2}$ .

A copper wire of cross-section  $A$  is under a tension  $T$ . Find the decrease in the cross-section area. Young's modulus is  $Y$  and Poisson's ratio is  $\sigma$ .

- (a)  $\frac{\sigma T}{2AY}$  (b)  $\frac{\sigma T}{AY}$   
(c)  $\frac{2\sigma T}{AY}$  (d)  $\frac{4\sigma T}{AY}$

$$\frac{\Delta r}{r} = \sigma \frac{\Delta l}{l} \text{ and } \frac{\Delta l}{l} = \frac{T}{AY}$$

$$\frac{\Delta A}{A} = \frac{2\Delta r}{r} = \frac{2\sigma T}{AY}$$

Properties of Material 5 ) Bending of the Beam

Depression of Beam at center

### The Depression of a Beam at its Centre

The depression at the centre of a beam is given by

$$= \frac{MgL^3}{4bd^3Y}$$

$M$  = Suspended Mass,  $L$  = Length of the beam,  $b$  = Bread of the beam,  
 $Y$  = Young's modulus and  $d$  = Thickness of the beam



**\*SUPPORTED BEAM, CENTRALLY LOADED.**  
*[Assumption : Weight of the beam is ineffective.]*

(i) If the beam is of circular cross-section, then depression  $y$  is given by :

$$y = \frac{WL^3}{12Y\pi r^4}$$

where  $W$  is the load suspended at the middle of the beam,  $L$  is the length of the beam between two supported points,  $Y$  is Young's modulus of elasticity and  $r$  is the radius of the circular cross-section of the beam.

(ii) If the beam is of rectangular cross-section of breadth  $b$  and depth  $d$ , then depression at the middle is given by

$$y = \frac{WL^3}{4Ybd^3}$$

**THE CANTILEVER—DEPRESSION OF ITS LOADED END**

*[Assumption : Weight of cantilever is ineffective]*

$$Y = \frac{WL^3}{3YI}$$

For a beam of rectangular cross-section of breadth  $b$  and depth  $d$ ,  $I = \frac{bd^3}{12}$

$$\therefore y = \frac{WL^3 \times 12}{3Y \times bd^3} = \frac{4WL^3}{Ybd^3}$$

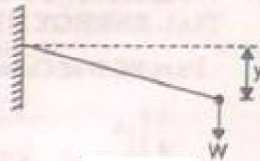

If the cross-section is square in shape, then  $b = d$ .

$$\therefore I = \frac{b^4}{12}$$

$$\therefore y = \frac{WL^3 \times 12}{3Yb^4} = \frac{4WL^3}{Yb^4}$$

For the beam of circular cross-section of radius  $r$ ,

$$I = \frac{\pi r^4}{4}$$

$$\therefore y = \frac{WL^3}{3Y \left[ \frac{\pi r^4}{4} \right]} = \frac{4WL^3}{3Y\pi r^4}$$

*For the same cross-sectional area and for given load, the ratio of depression for the beam of a square cross-section and circular cross-section is :*

- (a) 3 :  $\pi$   
(c) 1 :  $\pi$

- (b)  $\pi$  : 3  
(d)  $\pi$  : 1.

**Sol.**  $y_1 = \frac{4WL^3}{Yb^4}$ ,  $y_2 = \frac{4WL^3}{3Y\pi r^4}$

$$\frac{y_1}{y_2} = \frac{4WL^3}{Yb^4} \times \frac{3Y\pi r^4}{4WL^3} = \frac{3\pi r^4}{b^4} = \frac{3\pi r^4}{(\pi r^2)^2}$$

[ $\because b^2 = \pi r^2$ ]

$$= \frac{3}{\pi}$$

So, (a) is the right choice.

#### Properties of Material 6 ) Measurement of Radius of Curvature

*To measure the radius of curvature with a spherometer, we use the formula*

(a)  $R = \frac{h^2}{6} + \frac{l}{2}$

(b)  $R = \frac{l^2}{6h} + \frac{h}{2}$

(c)  $R = \frac{h^2}{2l} + \frac{l}{h}$

(d)  $R = \frac{2l^2}{h} + \frac{6}{l}$

A spherometer (Fig. 11) is used to determine the radius of curvature of a spherical surface. The theory of the method is briefly described below :

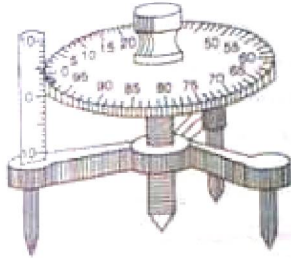

Fig. 11

In the Fig. 12,  $r^2 = h(2R - h)$

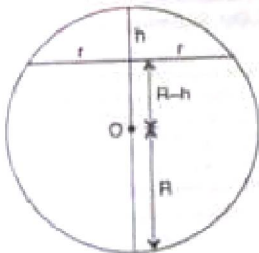

Fig. 12

On simplification,

$$R = \frac{r^2}{2h} + \frac{h}{2}$$

But

$$r = \frac{l}{\sqrt{3}}$$

[Think of an equilateral triangle of side  $l$ .]

$$\therefore R = \frac{l^2}{6h} + \frac{h}{2}$$

Properties of Material 7 ) Shear stress

A bar of cross-section  $A$  is subjected to equal and opposite tensile forces  $F$  at its ends. Consider a plane through the bar making an angle  $\theta$  with a plane at right angles to the bar. Then shearing stress will be maximum if  $\theta$

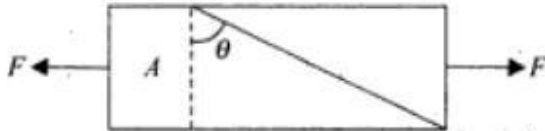

- (a)  $0^\circ$
- (b)  $30^\circ$
- (c)  $45^\circ$
- (d)  $60^\circ$
- (e)  $90^\circ$

(c) Shear stress =  $\frac{F \sin \theta}{A / \cos \theta} = \frac{F \sin 2\theta}{2A}$

Shear stress will be maximum if  $\sin 2\theta = 1$  or  $2\theta = 90^\circ$  i.e.  $\theta = 45^\circ$ .

Properties of Material 8 ) Thermal stress and force

Thermal Strees

(i) The thermal stress set up in the rod which is not free to expand or contract is given by,

$$\text{Stress in the rod} = \frac{F}{A} = Y \alpha (\theta_2 - \theta_1).$$

$Y$  = Young's modulus,  $\alpha$  = Linear coefficient of expansion and  $(\theta_2 - \theta_1)$  = Temperature difference.

(ii) Thermal force =  $F = YA \alpha (\theta_2 - \theta_1)$

(iii) Two different rods of different materials are joined end to end and the composite rod is fixed between the two supports. The temperature difference is  $(\theta_2 - \theta_1)$ . Then force is given by

$$F = \frac{L_1 \alpha_1 (\theta_2 - \theta_1) + L_2 \alpha_2 (\theta_2 - \theta_1)}{\frac{L_1}{A_1 Y_1} + \frac{L_2}{A_2 Y_2}}$$

Properties of Material 9 ) Proof Resilience

Proof resilience is related to

- (a) PE stored in an elastic body.
- (b) stiffness of a beam.
- (c) elastic fatigue.
- (d) elastic relaxation.

Ans : (a)

Properties of Material 10 ) Elongation in a Pendulum

A sphere of mass  $M$  kg is suspended by a metal wire of length  $L$  and diameter  $d$ . When in equilibrium, there is a gap of  $\Delta l$  between the sphere and the floor. The sphere is gently pushed aside so that it makes an angle  $\theta$  with the vertical. Find  $\theta_{\max}$  so that sphere fails to rub the Floor. Young's modulus of the wire is  $Y$ .

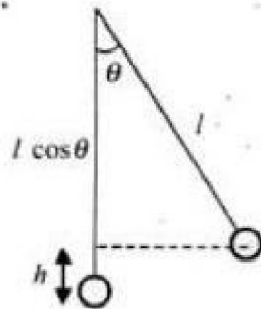

(a)  $\sin^{-1} \left( 1 - \frac{Y\pi d^2 \Delta l}{8MgL} \right)$       (b)  $\tan^{-1} \left( 1 - \frac{Y\pi d^2 \Delta l}{8MgL} \right)$   
(c)  $\cos^{-1} \left( 1 - \frac{Y\pi d^2 \Delta l}{8MgL} \right)$       (d) none

Ans :      (c)  $Y = \frac{Fl}{A\Delta l} = \frac{2Mg(1 - \cos \theta)L}{\pi \frac{d^2}{4} \Delta l}$

or  $1 - \cos \theta = \frac{Y\pi d^2 \Delta l}{8Mgl}$  or  $\cos \theta = 1 - \frac{Y\pi d^2 \Delta l}{8Mgl}$

$$\frac{mv^2}{2} = mgl(1 - \cos \theta)$$

or  $\frac{mv^2}{l} = 2mg(1 - \cos \theta)$

$$\theta = \cos^{-1} \left( 1 - \frac{Y\pi d^2 \Delta l}{8MgL} \right)$$

Properties of Material 11 ) Depression at center of rod

A wire of length  $L$  is clamped at two ends so that it lies horizontally and without tension. A weight  $W$  is suspended from the middle point of the wire. The vertical depression is \_\_\_\_ Young's modulus is  $Y$ .

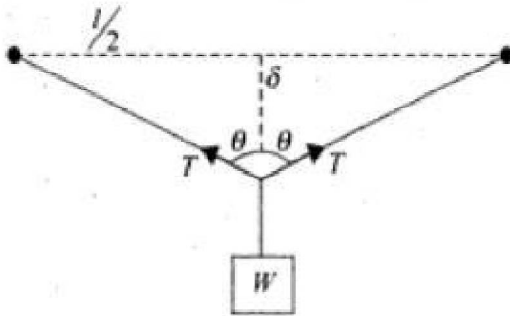

- (a)  $\sqrt{\frac{2Tl^2}{4AY} + \frac{T^2l^2}{4A^2Y^2}}$       (b)  $\sqrt{\frac{2Tl^2}{4AY} - \frac{T^2l^2}{4A^2Y^2}}$   
 (c)  $\sqrt{\frac{2Tl^2}{4AY}}$       (d)  $\frac{Tl}{2AY}$

(a)  $2T \cos \theta = W$

or  $T = \frac{W}{2 \cos \theta}$

$$\Delta l = \frac{Tl}{2AY} \quad \delta = \sqrt{\left(\frac{l}{2} + \Delta l\right)^2 - \frac{l^2}{4}}$$

or  $\delta = \sqrt{\left(\frac{l}{2} + \frac{Tl}{2AY}\right)^2 - \frac{l^2}{4}} = \sqrt{\frac{2Tl^2}{4AY} + \frac{T^2l^2}{4A^2Y^2}}$

Fluid 1 ) Bernoulli's Principle and Application

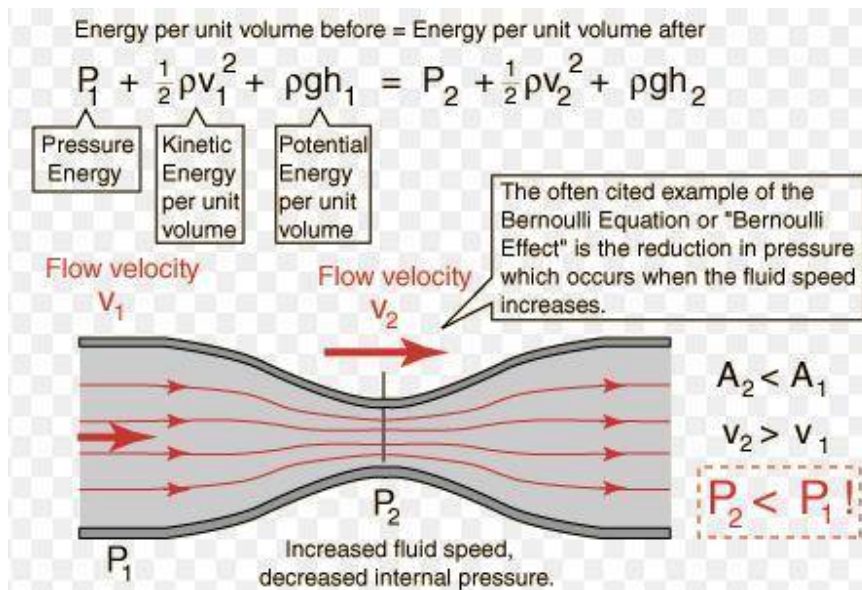

Differential velocity at top and bottom of an aircraft wing, for uplift

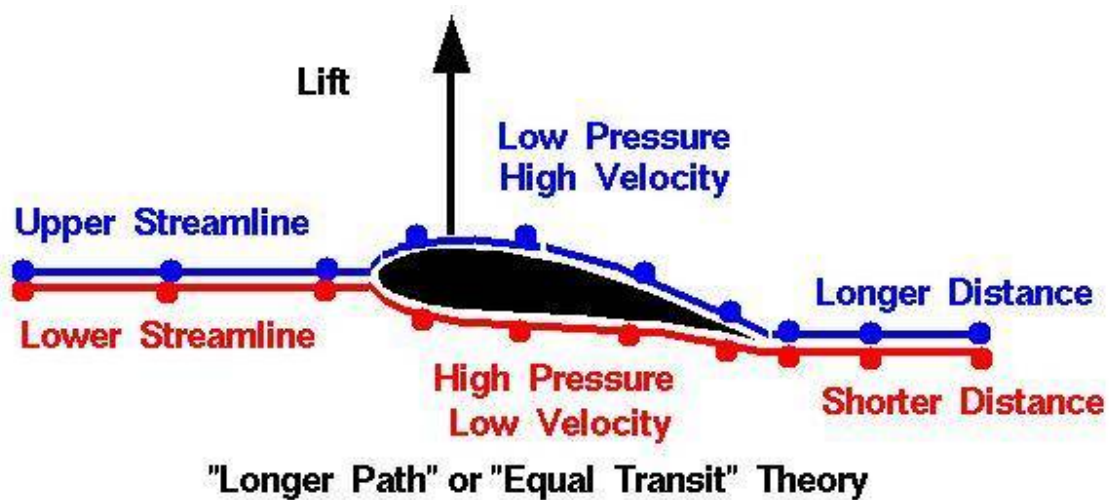



### Dynamic lift in aircraft

Aeroplanes get the dynamic lift because of the shape of their wings. The upper surface of the wing is made more curved than the lower surface; air flows with greater speed above the wing; pressure above the wing is less. The wing gets dynamic lift upwards.

$$\text{Dynamic lift} = (P_2 - P_1)A = \frac{1}{2}\rho(v_1^2 - v_2^2)A$$

Where  $\rho$  is the density of air,  $A$  is the area of the wing,  $v_1$  and  $v_2$  are the speeds of air above and below the wing and  $P_1$  and  $P_2$  are pressures above and below the wing.

**Air is streaming past a horizontal air plane wing such that its speed is  $90 \text{ m s}^{-1}$  at the lower surface and  $120 \text{ m s}^{-1}$  over the upper surface. If the wing is 10 m long and has an average width of 2 m, the difference of pressure on the two sides and the gross lift on the wing are [Density of air =  $1.3 \text{ kg m}^{-3}$ ]**

(a) 5 Pa, 900 N

(b) 95 Pa, 900 N

(c) 4095 Pa, 900 N

(d) 4095 Pa, 81900 N.

Ans :

Pressure Difference =  $\Delta P = \frac{1}{2}(\rho)v^2$

$$(d) P_2 - P_1 = \frac{1}{2} \times 1.3 [120^2 - 90^2] = 4095 \text{ Pa}$$

$$\text{Lift} = 4095 \times 2 \times 10 \text{ N} = 81900 \text{ N}$$

A pressure gradient is needed to accelerate the air around the curved upper surface of the wing. Thus the air just above the wing is a zone of low pressure.

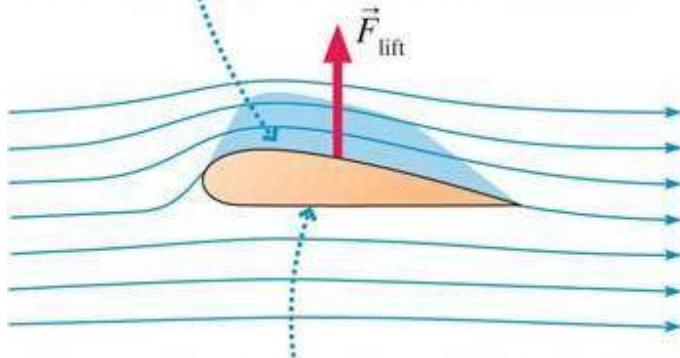

Because the pressure beneath the wing is higher than the pressure above, there's a net upward force on the wing. This is lift.

roof of hut being flown off due to strong wind

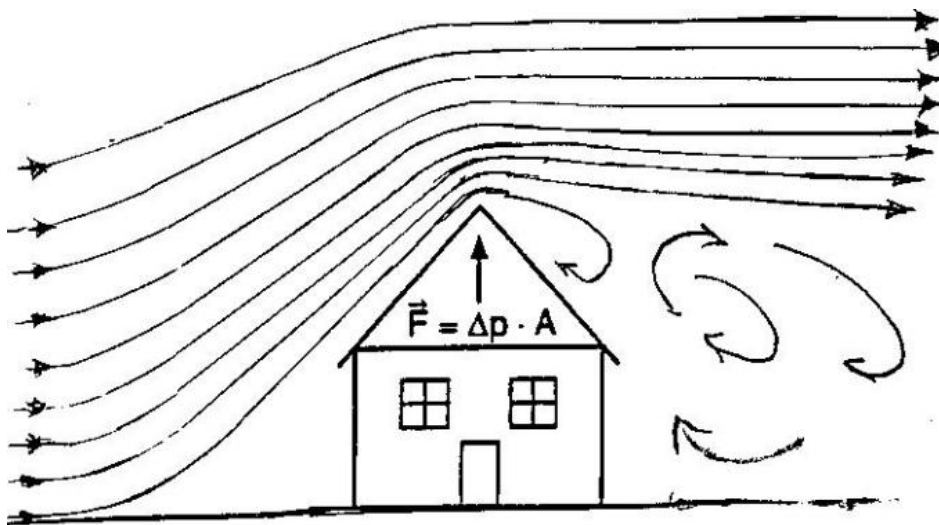

Fluid 2 ) Magnus Effect Top Spin

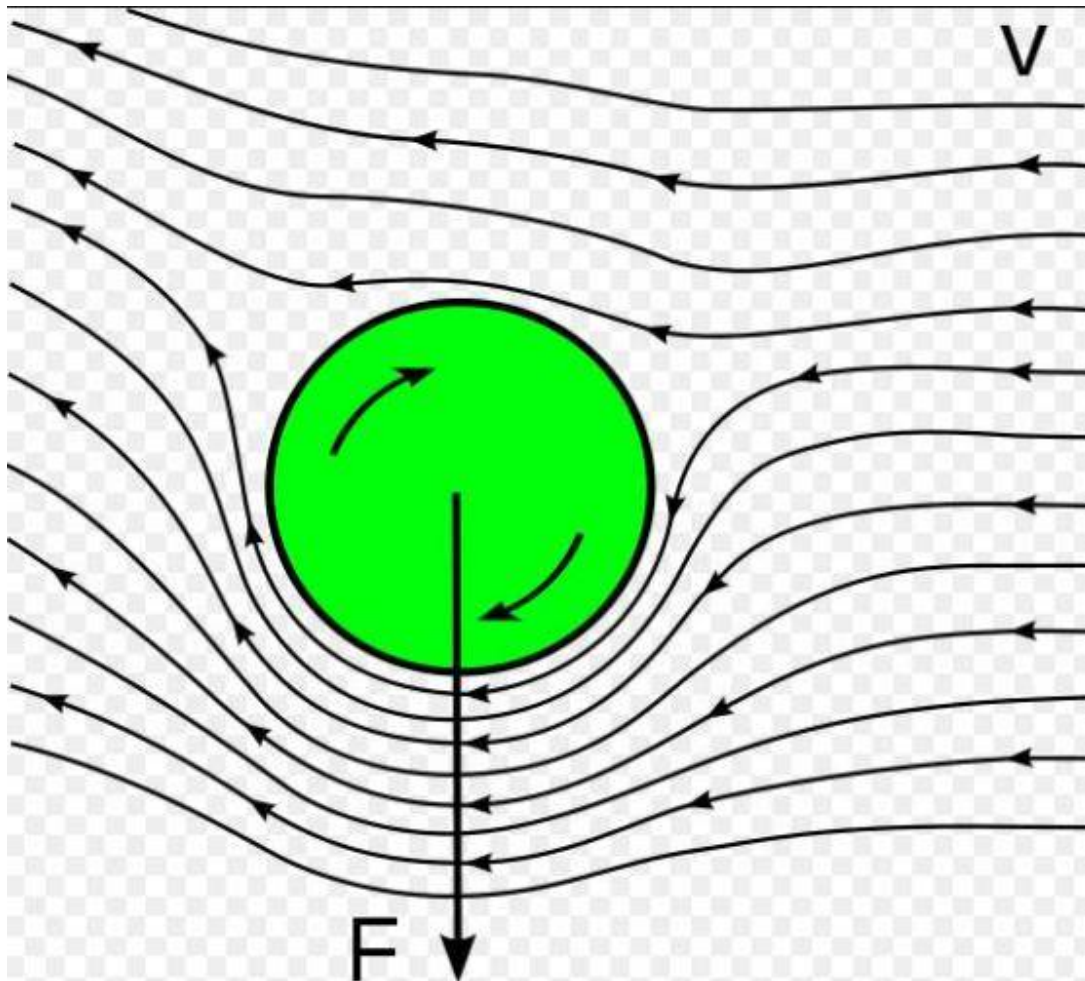

Magnus Effect lift

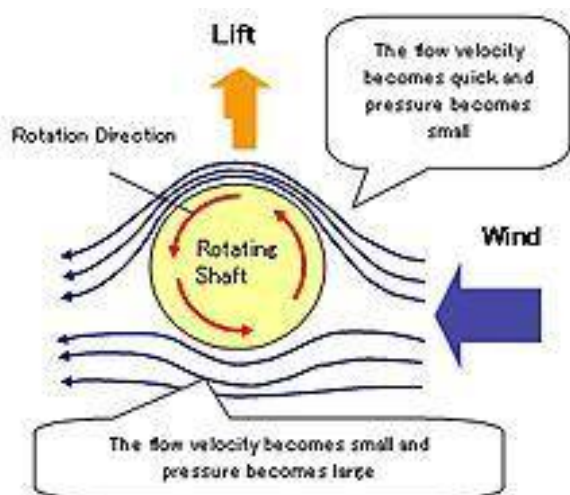

### Fluid 3 ) Reynold's Number

$$N_{Re} = \frac{D V C}{\eta}$$

**D = inside pipe diameter**

**V = average velocity**

**C = density**

**$\eta$  = absolute viscosity**

### Fluid 4 ) Surface Tension Formula

Work done = energy = Area  $\times$  Surface tension

Energy for film = 2(Area  $\times$  Surface tension)

Absorbed energy when drop of radius  $R$  splits into  $n$  identical drops of radius  $r$ , is

$$= 4\pi R^2(n^{1/3} - 1)T = 4\pi r^2 n^{2/3} (n^{1/3} - 1)T$$

Excess pressure inside the soap bubble =  $\frac{4T}{r}$

Excess pressure inside the liquid drop =  $\frac{2T}{r}$

Difference between convex concave side is

$$p = T \left( \frac{1}{r_1} + \frac{1}{r_2} \right)$$

When two drops of radii  $r_1, r_2$  coalesce to form a new drop of radius  $R$  under isothermal condition, then  $R = \sqrt{r_1^2 + r_2^2}$

When a soap bubble of radius  $r_1$  and another of radius  $r_2$  are brought together the radius of the common interface is  $\frac{1}{r} = \frac{1}{r_1} - \frac{1}{r_2}$

Fluid 5 ) Bulk Modulus and Compression of liquid

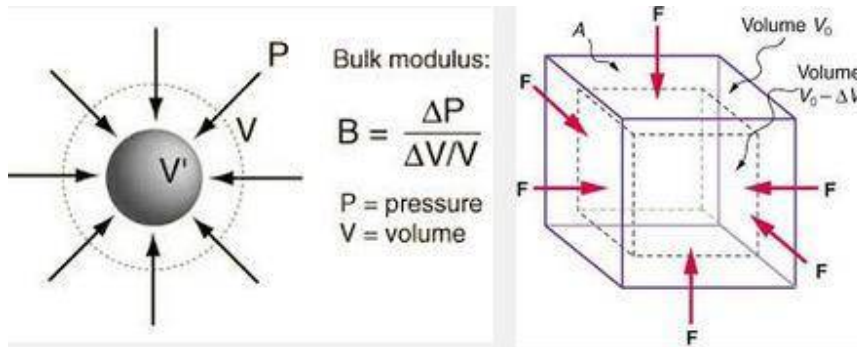

$$\beta = -\frac{\delta V}{V \delta p} = \text{Compressibility}$$

$$-\frac{\delta V}{V} = \frac{\delta p}{K} \quad K = \rho \frac{dp}{d\rho}$$

$$V = \frac{1}{\rho} \quad K = \text{Bulk Modulus}$$

$\rho = \text{Density,}$

$V = \text{Volume, } p = \text{Pressure,}$

Find the density of water 2 km deep in a sea. Bulk modulus =  $2 \times 10^9$  Pa.

- (a)  $10^3 \text{ kgm}^{-3}$                       (b)  $1010 \text{ kgm}^{-3}$   
 (c)  $1100 \text{ kgm}^{-3}$                       (d)  $1040 \text{ kgm}^{-3}$

$$(b) \frac{\Delta V}{V} = \frac{P}{B} = \frac{2 \times 10^3 \times 10^3 \times 10}{2 \times 10^9} = .01$$

$$\frac{\Delta V}{V} = \frac{\Delta \delta}{\delta} \text{ or } \Delta \delta = 10 \text{ kg/m}^3.$$

density of water =  $1010 \text{ kg m}^{-3}$

The average depth of Indian Ocean is about 3000 m. Bulk modulus of water is  $2.2 \times 10^9 \text{ Nm}^{-2}$ ,  $g = 10 \text{ ms}^{-2}$ , then fractional compression  $\left(\frac{\Delta V}{V}\right)$  of water at the bottom of the Indian Ocean is

- (a) 1.36%      (b) 20.6%      (c) 13.9%      (d) 0.52%

**Interpret** (a) The pressure exerted by a 3000 m column of water on the bottom layer

$$p = h\rho g = 3000 \times 1000 \times 10 \\ = 3 \times 10^7 \text{ kg m}^{-1} \text{ s}^{-2} = 3 \times 10^7 \text{ Nm}^{-2}$$

Fractional compression  $\left(\frac{\Delta V}{V}\right)$

$$= \frac{\text{Stress}}{B} = \frac{(3 \times 10^7 \text{ Nm}^{-2})}{(2.2 \times 10^9)} = 1.36 \times 10^{-2}$$

$$\frac{\Delta V}{V} = 1.36\%$$

Find the volume density of elastic energy of fresh water at a depth of 1000 m

- (a)  $2.5 \text{ kJm}^{-3}$       (b)  $25 \text{ kJm}^{-3}$   
 (c)  $0.25 \text{ kJm}^{-3}$       (d) none

$$(b) \frac{dW}{V} = \frac{1}{2} P \frac{\Delta V}{V} = \frac{1}{2} P \left(\frac{P}{B}\right) \\ = \frac{(\rho gh)^2}{2 \times 2 \times 10^9} = \frac{(10^3 \times 10 \times 10^3)^2}{2 \times 2 \times 10^9} = 2.5 \times 10^4 \text{ J/m}^3.$$

A diver at a depth of 45 m exhales a bubble of air that is 1.0 cm in radius. Assuming ideal gas behaviour, what will be the radius of this bubble as it breaks the surface of water?

**Plan** Inside water  $P_{\text{Total}} = \text{atmospheric pressure} + \rho gh$

Using  $P_1V_1 = P_2V_2$ ,  $V_2$  at the surface of water is calculated ( $V_2$  is the volume of bubble at the surface), thus,  $r$  can be calculated.

**Solution** Atmospheric pressure = 1 atm.

Pressure due to depth of 45 m =  $\rho gh$

where  $\rho$  = density of water =  $1 \text{ g cm}^{-3} = 1000 \text{ kg m}^{-3}$ ,  
 $g = 9.81 \text{ m s}^{-2}$ ,  $h = 45 \text{ m}$

$$\rho gh = 1000 \times 9.81 \times 45 \text{ N m}^{-2}$$

$$= \frac{1000 \times 9.81 \times 45}{101325} \text{ atm} = 4.36 \text{ atm}$$

$$(\because 1 \text{ atm} = 1.01325 \times 10^5 \text{ N m}^{-2})$$

$$\therefore P_1 = \text{atmospheric pressure} + \rho gh = 1 + 4.36 = 5.36 \text{ atm}$$

$$P_2 = 1 \text{ atm}$$

$$V_1 = \frac{4}{3} \pi r^3 = \frac{4}{3} \times \pi \times (1)^3 \text{ cm}^3$$

$$V_2 = \frac{4}{3} \pi r^3 = \text{volume of bubble at } P_2 \text{ (at the surface)}$$

using

$$P_1V_1 = P_2V_2$$

$$V_2 = \frac{P_1V_1}{P_2}$$

$$\frac{4}{3} \pi r^3 = \frac{5.36 \times \frac{4}{3} \pi (1)^3}{1}$$

$$r^3 = 5.36 \text{ cm}^3$$

$$r = 1.75 \text{ cm}$$

Fluid 6 ) Time taken for water to go from  $h_1$  to  $h_2$

A cylindrical vessel of area of cross-section  $A$  has a hole of area of cross-section ' $a$ ' in its bottom. Time taken for the water level to decrease from  $h_1$  to  $h_2$  as water flows out from the hole is

$$t = \frac{A}{a} \sqrt{\frac{2}{g}} (\sqrt{h_1} - \sqrt{h_2})$$

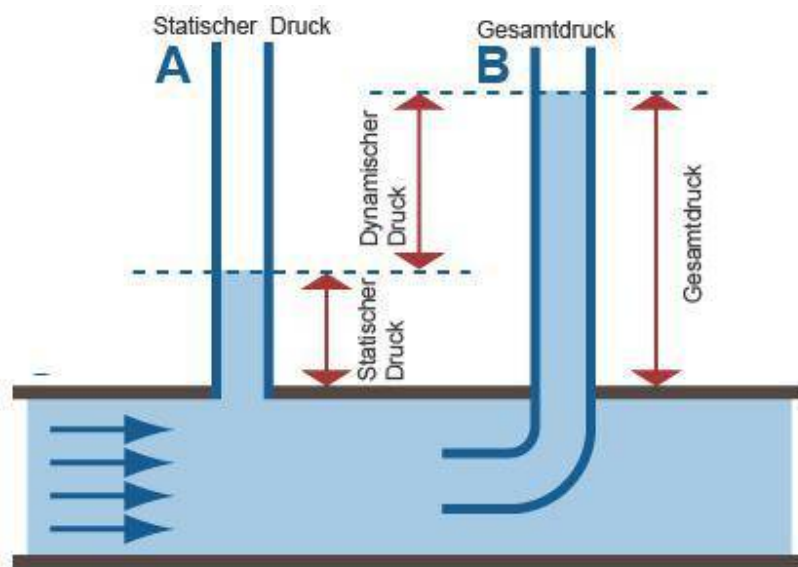
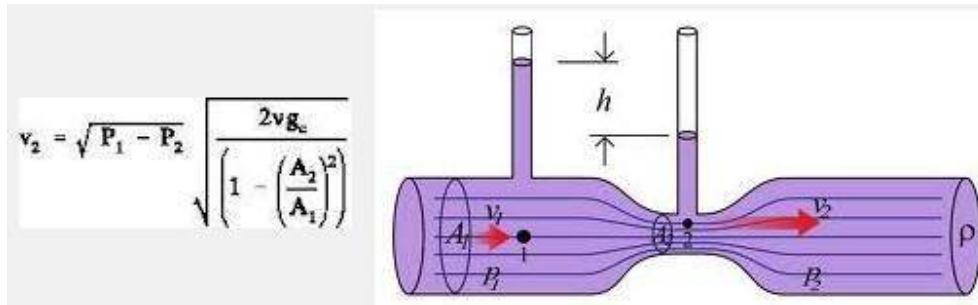

Application of Bernoulli's Equation in Siphon



## Application of Bernoulli's Equation

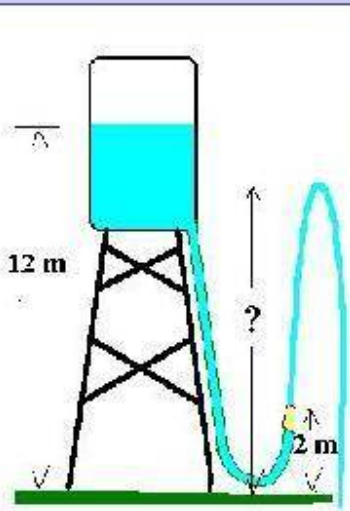

Water level is 12 m above ground. Hose nozzle is 2.0 m above ground.

- 1 What is (gauge) pressure in hose at nozzle?
- 2 What is water speed at nozzle?
- 3 How high does water squirt?

Magnetic Properties of Materials 1 ) Diamagnetic, Paramagnetic, Ferrimagnetic, Antiferromagnetic

**Magnetic Properties :** Solids can be classified into different types depending upon their behaviour towards applied magnetic field.

**a. Diamagnetic Substances :** Which are weakly repelled by magnetic field. They have paired electrons. NaCl,  $V_2O_5$ ,  $TiO_2$ .

**b. Paramagnetic Substances :** Which are weakly attracted by magnetic field. They have permanent dipoles due to presence of unpaired electrons. They lose their magnetism on removal of magnetic field.  $TiO$ ,  $Ti_2O_3$ ,  $VO$ ,  $VO_2$ ,  $CuO$ .

**c. Ferromagnetic Substances :** Spontaneous alignment of magnetic dipoles of ions or atoms in same direction. It changes into paramagnetic substances at higher temperature. Fe, Co, Ni,  $CrO_2$ .

**d. Ferrimagnetic Substances :** Alignment of magnetic dipoles of ions or atoms in such a way so that there is some net magnetic moment due to unequal number of parallel and anti-parallel magnetic dipoles. It also changes into paramagnetic substances at higher temperature.  $Fe_3O_4$ .

**e. Anti Ferromagnetic Substances :** Alignment of magnetic dipoles of ions or atoms in such a way so that there is no net magnetic moment (i.e. zero magnetic moment) due to equal number of parallel and anti-parallel magnetic dipoles.  $V_2O_3$ ,  $Cr_2O_3$ ,  $MnO$ ,  $Mn_2O_3$ ,  $MnO_2$ ,  $FeO$ ,  $Fe_2O_3$ ,  $CoO$ ,  $NiO$ .

### Projectile Problems

In Professor H C Verma's book there are less than 10 Projectile problems. This is insufficient.

### **Range and time of flight along an inclined plane**

Consider an inclined plane of inclination  $\alpha$ . Let a projectile be fixed at an angle  $\theta$  with the horizontal or at an angle  $(\theta - \alpha)$  with respect to incline plane as shown in Fig.

$$\text{The time of flight } T' = \frac{2u \sin(\theta - \alpha)}{g \cos \alpha}$$

$$\text{Range } R' = \frac{2u^2 \sin(\theta - \alpha) \cos \theta}{g \cos^2 \alpha}$$

$$R = \frac{u^2}{g \cos^2 \alpha} [\sin(2\theta - \alpha) - \sin \alpha]$$

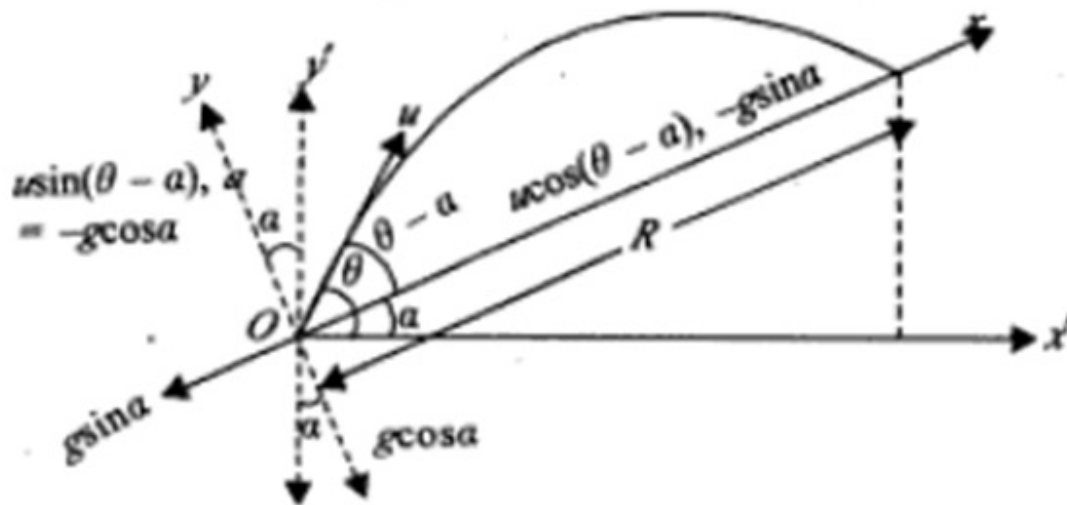

### Projectile motion along an incline

Range  $R$  along the inclined is maximum if  $2\theta - \alpha = \frac{\pi}{2}$

or  $\theta - \alpha = \frac{\pi}{2} - \theta$ . That is,  $R$  is maximum when the direction of projection bisects the angle that the inclined plane makes

with  $Oy'$  and  $R_{\max} = \frac{u^2}{g \cos^2 \alpha} \cdot [1 - \sin \alpha]$

**Note:** In projectile motion along the plane acceleration acts along  $x$  and  $y$  axis both.

Question

A ball is thrown up with a certain velocity so that it reaches a height  $h$ . Find the ratio of the times in which it is at  $\frac{h}{3}$ .

(a)  $\frac{\sqrt{2}-1}{\sqrt{2}+1}$

(b)  $\frac{\sqrt{3}-\sqrt{2}}{\sqrt{3}+\sqrt{2}}$

(c)  $\frac{\sqrt{3}-1}{\sqrt{3}+1}$

(d)  $\frac{1}{3}$

**Solution** (b)  $u^2 = 2gh$ ;  $\frac{h}{3} = \sqrt{2gh} t - \frac{1}{2} g t^2$ . or  $g t^2 - 2$

$$\sqrt{2gh} t + \frac{2h}{3} = 0.$$

$$t = \frac{2\sqrt{2gh} \pm \sqrt{8gh - (8gh)/3}}{2g}$$

$$\frac{t_1}{t_2} = \frac{2\sqrt{2gh} - 2\sqrt{2gh/3}(\sqrt{3}-1)}{2\sqrt{2gh} + 2\sqrt{2gh/3}(\sqrt{3}-1)}$$

$$= \frac{\sqrt{3} - (\sqrt{3}-1)}{\sqrt{3} + \sqrt{3}-1}$$

$$= \frac{\sqrt{3} - \sqrt{2}}{\sqrt{3} + \sqrt{2}}$$

Question

The displacement of a particle varies with time as  $x = a e^{-at} + b e^{\beta t}$  where  $a, a, b, \beta$  are positive constants. The velocity of the particle

- (a) will be independent of  $a$  and  $\beta$
- (b) drop to zero when  $a = \beta$
- (c) go on decreasing with time
- (d) go on increasing with time.

**Solution** (d)  $\frac{dx}{dt} = -aa e^{-at} + b\beta e^{\beta t}$  as  $t$  increases  $\frac{-aa}{e^{at}}$  decreases and  $b\beta e^{\beta t}$  increases.

Question

Convert given  $v - x$  shown in Fig to  $a - x$  graph.

( IIT Screening 2005)

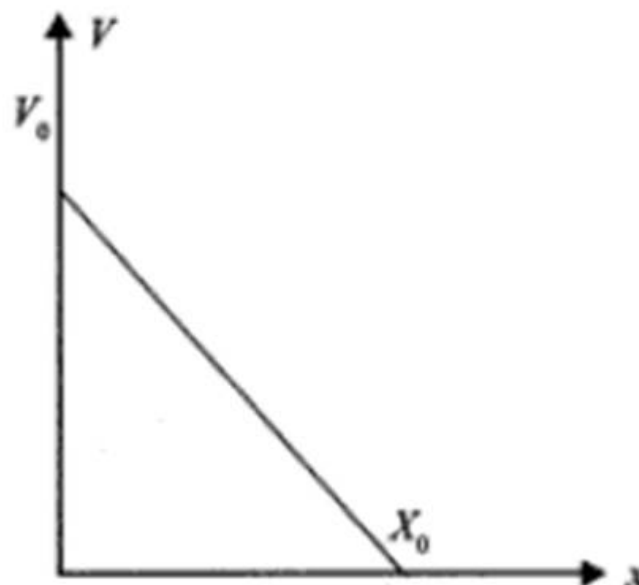

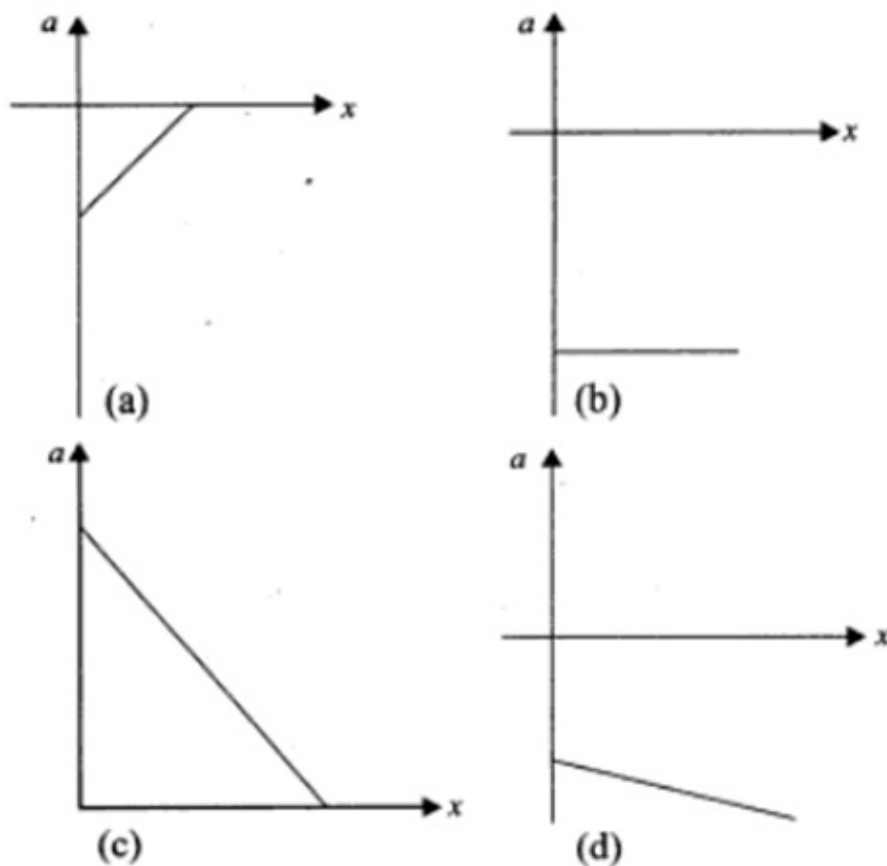

**Solution** (a) equation of given curve is  $v = \left(1 - \frac{x}{x_0}\right) v_0$

$$a = \frac{dv}{dt} = -\frac{v_0}{x_0} \frac{dx}{dt} = \frac{-v_0^2}{x_0} \left(1 - \frac{x}{x_0}\right).$$

Question

The relation between time  $t$  and distance  $x$  is  $t = ax^2 + bx$

where  $a$  and  $b$  are constant. The acceleration is

- (a)  $-2a bv^2$                       (b)  $2 bv^3$   
 (c)  $-2 av^3$                       (d)  $2 av^2$

**Solution** (c)  $t = ax^2 + bx$  or  $\frac{dt}{dx} = 2ax + b$

or  $v = \frac{dx}{dt} = \frac{1}{2ax + b}$

$$\frac{dv}{dt} = \frac{-2a}{(2ax + b)^2} \frac{dx}{dt} = \frac{-2a}{(2ax + b)^3} = -2a v^3.$$

Question

A car starting from rest accelerates at the rate  $f$  through a distance  $s$ , then continues at constant speed for time

$t$  and then decelerates at rate  $\frac{f}{2}$  to come to rest. If the

total distance covered is  $15s$ , then

(a)  $s = \frac{ft^2}{72}$

(b)  $s = \frac{ft^2}{4}$

(c)  $s = \frac{ft^2}{6}$

(d)  $s = \frac{ft^2}{2}$

**Solution** (a)  $s = v_0 t_1$  and  $v_0 2t_1 = 2s$

Distance moved with uniform speed  $(15 - 3) s = 12 s$

$$v_0 = \sqrt{2sf} ; 12s = v_0 t$$

$$12s = t \sqrt{2sf} \quad \text{or} \quad s = \frac{ft^2}{72}$$

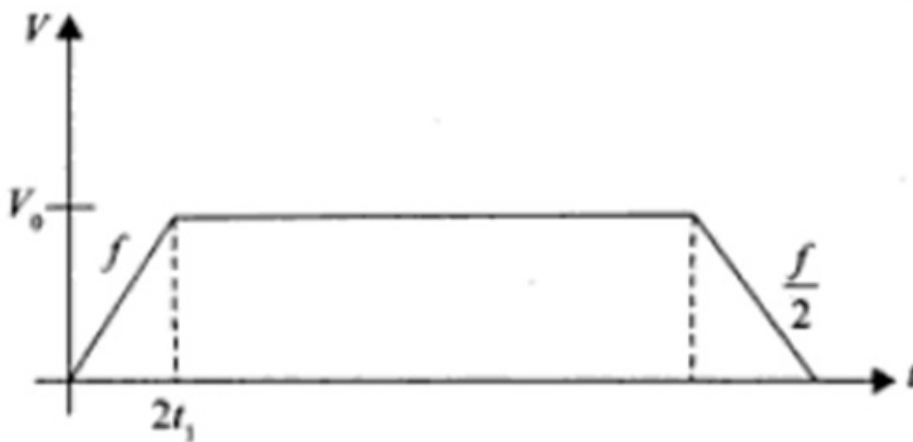



### Question

A projectile is any body that is given an initial velocity and then follows a path determined entirely by the effects of gravitational acceleration and air resistance. A batted baseball, a thrown football, a package dropped from an airplane, and a bullet shot from a rifle are all projectiles. The path followed by a projectile is called its trajectory.

Represent the projectile as a single particle with an acceleration (due to gravity) that is constant in both magnitude and direction. Neglect the effects of air resistance and the curvature of the Earth and its rotation. Like all models, this one has limitations. Curvature of the earth has to be considered in the flight of long range missiles and air resistance is of crucial importance to a sky diver.

1. If air resistance is considered, then the maximum height achieved by the projectile
  - (a) decreases
  - (b) increases
  - (c) remains unchanged
  - (d) very difficult to answer as no data provided

**Solution** (a)

2. Air resistance is proportional to

(a)  $v$

(b)  $v^2$

(c)  $v^{-2}$

(d)  $v^3$

**Solution** (b) To a good approximation air resistance  $\propto v^2$ .

3. Comparing with no air-resistance curve, for the motion of a baseball with effect of air resistance, the correct curve will be

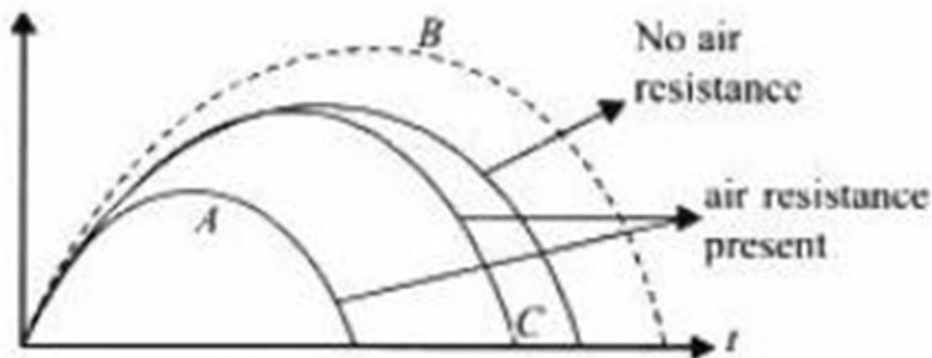

(a)  $A$

(b)  $B$

(c)  $C$

(d) none

**Solution** (a)

4. A gun is fired horizontally on the bull's eye at a height  $h$
- (a) The bullet hits the bull's eye
  - (b) The bullet moves left or right of the Bull's eye due to jerk experienced on firing
  - (c) The bullet misses the bull's eye and hits upward
  - (d) The bullet misses the target and hits downwards

**Solution** (d) due to gravity it follows projectile path (parabolic) and moves downward.

Question

Journey in a train is adventurous particularly when you have a seat. The girl sitting near the window ate a banana and dropped the peel from the window. Her copassenger looking through the window found that it dropped vertically down and touched the ground in 0.2 s. After some time she requested her sister sitting on the upper berth to drop a chocklate bar. The sister dropped the bar, but it fell in front of the girl instead of reaching her hand. She was angry but the co-passenger calmed her by saying that she dropped exactly in line of your hand but as the train is accelerating it did not reach you and fell in front of you.

1. Is the co-passenger's explanation to the girl correct?

**Solution** No, the train is actually retarding. When the girl on the upper berth released the chocolate train was faster and the chocolate acquired the same horizontal velocity but the train retarded and became slow. Therefore, the girl sitting on the lower berth (due to motion of train) covered lesser distance and the chocolate covered longer distance and fell in front of her hands.

2. An observer standing outside the train finds the banana peel moving

- (a) vertically down                      (b) in parabolic path  
(c) horizontally                          (d) cycloid

**Solution**    (b)

3. If the train would have moved with uniform velocity the chocolate will fall

- (a) behind her hands                      (b) towards left  
(c) towards right                          (d) in her hands

**Solution**    (d)

4. If a projectile has velocity  $>$  escape velocity which trajectory it will follow

- (a) elliptic                                      (b) hyperbolic  
(c) vertical straight                          (d) parabolic

**Solution**    (b)

5. Two particles are thrown with  $8 \text{ ms}^{-1}$  as shown in Fig. 3.42 one horizontally from a height of 40 m and the other from a height of 50 m in making an angle  $60^\circ$  with the vertical. They strike in mid air. Find the coordinates of strike point and distance between the buildings.

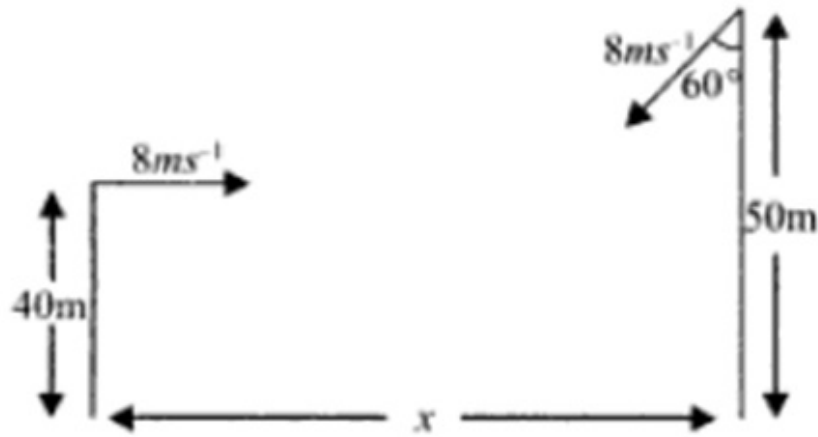

**Solution**  $\frac{1}{2} gt^2 = y ; y + 10 = 8 \cos 60t + \frac{1}{2} gt^2$

$$y_1 = \frac{10}{2} \times (2.5)^2 = 31.25 \text{ m ;}$$

$$y_2 = y_1 + 10 = 41.25 \text{ m}$$

$$x_1 = 8 (2.5) = 20 \text{ m ;}$$

$$x_2 = 8 \sin 60 \times 2.5 = 17.32 \text{ m}$$

$$x = 20 + 17.32 = 37.32 \text{ m}$$

Question

Electrons, nuclei, atoms and molecules like all forms of matter, will fall under the influence of gravity. Consider separately the beam of electrons, of nuclei, of atoms and of molecules travelling a horizontal distance of 1 m. Let the average speed of electrons be  $3 \times 10^7 \text{ ms}^{-1}$ , for a thermal neutron  $2.2 \times 10^5 \text{ ms}^{-1}$ , for a neon atom  $5.8 \times 10^2 \text{ ms}^{-1}$  and for an oxygen molecule  $4.6 \times 10^2 \text{ ms}^{-1}$ . The beams move through vacuum horizontally with initial velocities mentioned above. A golf ball is also projected horizontally with  $20 \text{ ms}^{-1}$  in vacuum.

1. Out of the given beams which deviates maximum in travelling 2 m?  
(a) electron beam                      (b) neutron beam  
(c) neon atom                              (d) oxygen atom
2. Find the deviation of golf ball in travelling through 2 m.  
(a) 2 cm                                      (b) 5 cm  
(c) 8 cm                                      (d) 3.6 cm
3. Is there any effect of electron-electron repulsion?  
(a) Yes                                      (b) No  
(c) insufficient data to reply              (d) none

**Solution**

1. (d) Deviation  $y = \frac{1}{2} g t^2$  and  $t = \frac{x}{v}$  or  $y = \frac{1}{2} g \left( \frac{x}{v} \right)^2$ .

2. (b)  $y = \frac{1}{2} g \left( \frac{2}{20} \right)^2 = 5 \text{ cm}$

3. (b) Since the net velocity has already taken into account the repulsion, no effect of repulsion is to further added.

Question

**Radar is used for ranging of the projectiles. A radar observer on the ground is watching an approaching projectile. At a certain instant, he gathers the following information. The projectile has reached maximum altitude and is moving**

**horizontally with a speed  $v$ , the straight line distance of the projectile is  $l$ . The line of sight to the projectile is an angle  $\theta$  above the horizontal.  $D$  is the distance between the observer and the point of impact of the projectile. Assume observer lies in the plane of the trajectory and the Earth is flat in that part.**

**1. Find  $D$  in terms of  $l$ ,  $v$  and  $\theta$ .**

(a)  $\frac{gl^2}{v^2} \cot \theta$

(b)  $\frac{gl^2}{v^2} \tan \theta$

(c)  $\frac{gl^2}{2v^2} \tan \theta$

(d)  $\frac{gl^2}{2v^2} \cot \theta$

2. Does the projectile pass over his head before reaching him?

(a) Yes

(b) No

(c) insufficient data to reply

**Solution** 1. (d)  $l = \frac{u^2 \sin \alpha \cos \alpha}{g} = \frac{v}{g} v_x$

$$v_x = \frac{gl}{v}$$

$$h = \frac{v_x^2}{2g} = \frac{g^2 l^2}{2v^2 g} = \frac{gl^2}{2v^2}$$

$$\frac{D}{h} = \cot \theta$$

or  $D = h \cot \theta = \frac{gl^2}{2v^2} \cot \theta$

2(c) If  $\theta < \alpha$ , the angle of projection of projectile, then the projectile will fall before reaching him.



Radius of Curvature of a Projectile

Find the radius of curvature of the trajectory of a projectile projected with velocity  $u$  at an angle  $\alpha$  with the horizontal after  $t$  seconds from the instant of projection.

**Solution :** We have,

$$\vec{r} = u \cos \alpha t \hat{i} + (u \sin \alpha t - \frac{1}{2}gt^2) \hat{j}$$

$$\vec{v} = u \cos \alpha \hat{i} + (u \sin \alpha - gt) \hat{j}$$

Let  $\theta$  be the angle made by the velocity with the horizontal. Then

$$\tan \theta = \frac{u \sin \alpha - gt}{u \cos \alpha}$$

The component of  $mg$  along the normal is  $mg \cos \theta$  and that is the centripetal force.

$$\therefore mg \cos \theta = \frac{mv^2}{R_c}, R_c = \text{radius of curvature.}$$

$$\begin{aligned} \Rightarrow R_c &= \frac{v^2}{g \cos \theta} = \frac{u^2 \cos^2 \alpha + (u \sin \alpha - gt)^2}{u \sin \alpha} \\ &= \frac{g \sqrt{u^2 \cos^2 \alpha + (u \sin \alpha - gt)^2}}{\{u^2 \cos^2 \alpha + (u \sin \alpha - gt)^2\}^{3/2}} \\ &= \frac{gu \sin \alpha}{\{u^2 \cos^2 \alpha + (u \sin \alpha - gt)^2\}^{3/2}} \end{aligned}$$

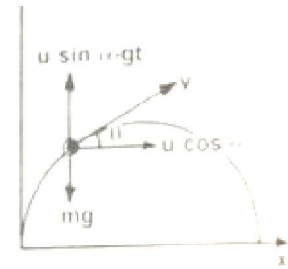

A Special Problem on Average Relative Velocity

A large number of particles are moving each with velocity  $v$  having directions of motion randomly distributed. What is the average relative velocity between any two particles averaged over all the pairs?

- (a)  $v$                       (b)  $\frac{\pi}{4} v$                       (c)  $\frac{4}{\pi} v$                       (d)  $4\pi v$

Relative velocity:  $v_r = |\vec{v}_1 - \vec{v}_2|$

where  $v_1 = v_2 = v$

If angle between them be  $\theta$ , then

$$\begin{aligned}v_r &= \sqrt{v^2 + v^2 - 2v^2 \cos \theta} \\ &= \sqrt{2v^2(1 - \cos \theta)} = 2v \sin (\theta/2)\end{aligned}$$

Hence, average relative velocity

$$\vec{v}_r = \frac{\int_0^{2\pi} 2v \sin \frac{\theta}{2} d\theta}{\int_0^{2\pi} d\theta} = \frac{4v}{\pi}$$

A modified problem from Irodov regarding "Spring constant" and height of fall

Two discs each having mass  $m$  are attached rigidly to ends of a spring. One of the discs rests on a horizontal surface and the other produces a compression  $x$  on the spring when it is in equilibrium. How much further must the spring be compressed so that when the force causing the compression is removed the extension of the spring will be able to lift the lower disc off the table?

- (a)  $x$  (b)  $2x$   
(c)  $1.5x$  (d)  $3x$

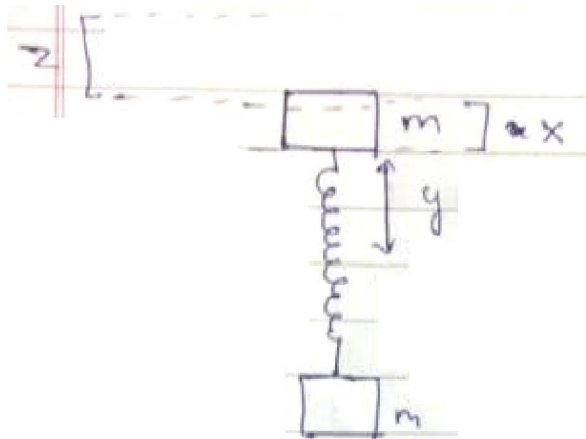

Initially, the spring is compressed by  $x$  to balance  $mg$  of top block  
 $\therefore kx = mg \Rightarrow x = \frac{mg}{k}$

The block should be pushed down by  $y$  such that when the spring reaches position  $z$ , bottom block should jump up.  
 $\therefore kz = Mg \Rightarrow z = \frac{Mg}{k}$

Using energy conservation,

$$\frac{1}{2} k (x + y)^2 = \frac{1}{2} k z^2 + mg(z + y + z)$$

$$\frac{1}{2} k \left( \frac{mg}{k} + y \right)^2 = \frac{1}{2} k \left( \frac{2mg}{k} \right)^2 + mg \left( \frac{2mg}{k} + y \right)$$

$$k \left( \frac{mg}{k} + y \right)^2 = k \left( \frac{mg}{k} \right)^2 + 2mg \left( \frac{2mg}{k} + y \right)$$

$$\Rightarrow k \left( \frac{m^2g^2}{k^2} + \frac{2mgy}{k} + y^2 \right) = k \left( \frac{m^2g^2}{k^2} \right) + \frac{4m^2g^2}{k} + 2mgy$$

$$\Rightarrow \frac{m^2g^2}{k} + 2mgy + y^2 k = \frac{m^2g^2}{k} + \frac{4m^2g^2}{k} + 2mgy$$

$$\Rightarrow y^2 = \frac{4m^2g^2}{k^2} \Rightarrow y^2 = 4a^2$$

$$\Rightarrow \boxed{y = 2a}$$

So, if the block is pushed down by distance  $2a$  more, when released, the system will jump up

### Melde's Experiment

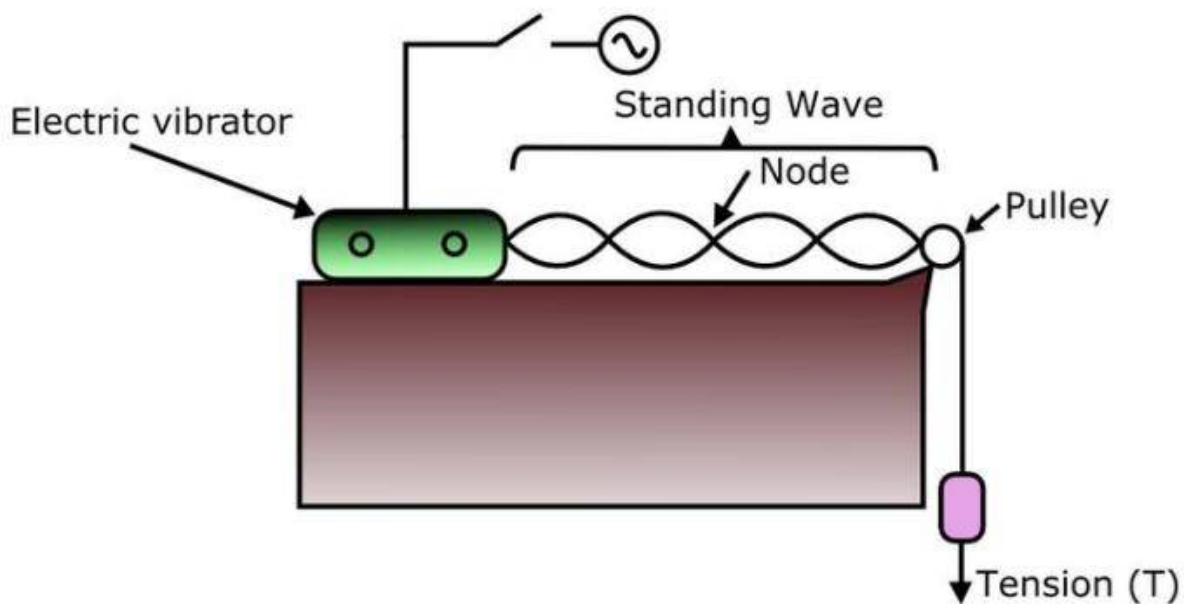

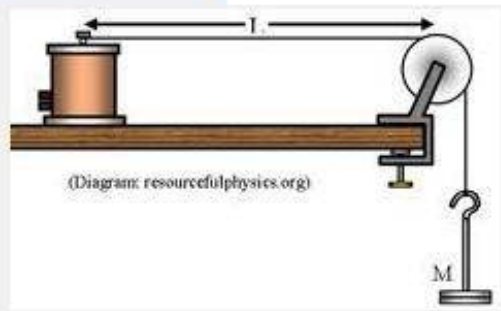
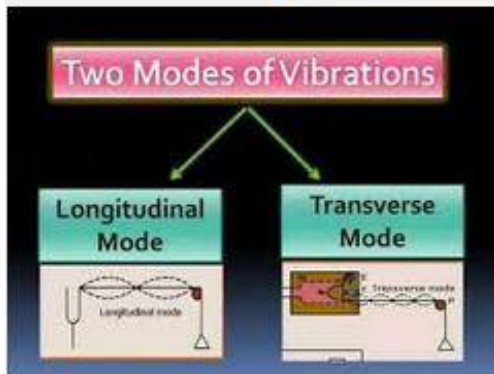
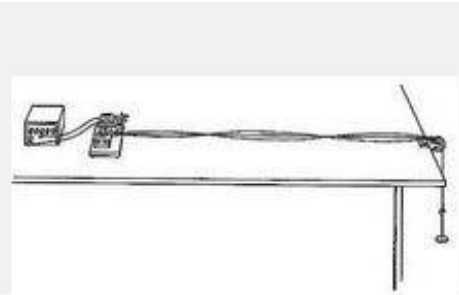
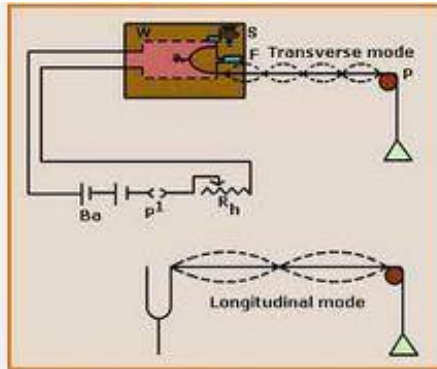

$$f = \frac{n}{2L} \sqrt{\frac{T}{m}}$$

A plane wave  $\zeta = A \cos(\omega t - kx)$  propagates in the reference frame  $S$ . Find the equation of this wave in a reference frame  $S'$  moving in the +ve direction of  $x$ -axis with a constant velocity  $V$  relative to  $S$ .

$$x = x' + Vt \quad \therefore \quad \frac{dx}{dt} = \frac{dx'}{dt} + V$$

$$\therefore \quad \xi' = A \cos \{ \omega t - k(x' + Vt) \} = A \cos \{ (\omega - kV)t - kx' \}$$

$$\text{or} \quad \xi' = A \cos \left\{ \omega t \left( 1 - \frac{kV}{\omega} \right) - kx' \right\}.$$

Let  $D = \dots$   
 But  $\frac{k}{\omega} = v$ , velocity of wave.

$$\therefore \quad \xi' = A \cos \left[ \omega \left( 1 - \frac{V}{v} \right) t - kx' \right].$$

Which of the following represents (a) a progressive wave and (b) a stationary wave?

(a)  $y = 2 \cos 5x \sin 9t$ , (b)  $y = 2 \sqrt{x - vt}$ ,

(c)  $y = 3 \sin (5x - 0.5t) + 4 \cos (5x - 0.5t)$

(d)  $y = \cos x \sin t + \cos 2x \cdot \sin 2t$ . If progressive, find its velocity.

(a) Stationary wave; (b) unacceptable for wave.

(c) Put  $3 = A \cos \phi$ ,  $4 = A \sin \phi$ .

Then  $y = A \cos \phi \sin (5x - 0.5t) + A \sin \phi \cos (5x - 0.5t)$

$y = A \sin (5x - 0.5t + \phi)$ .

This fits the equation of progressive wave in the standard form:

$$y = A \sin \left( \frac{2\pi}{\lambda} x - \omega t + \phi \right).$$

$\therefore$  Here  $\frac{2\pi}{\lambda} = 5$  and  $0.5 = \omega$

$\therefore v = n\lambda \frac{0.5}{2\pi} \times \frac{2\pi}{5} = 0.1 \text{ m/s.}$

(d) Superposition of two stationary waves.

A wave problem with interpretation of equation

The shape of a wave is represented by  $y = \frac{1}{1+x^2}$  at  $t = 0$  and  $y = \frac{1}{1+(x-1)^2}$  at  $t = 2s$ . Assume that the shape of the wave remains unaltered as it advances in the medium. Find the velocity of the wave and represent the wave graphically.

[IIT 1990]

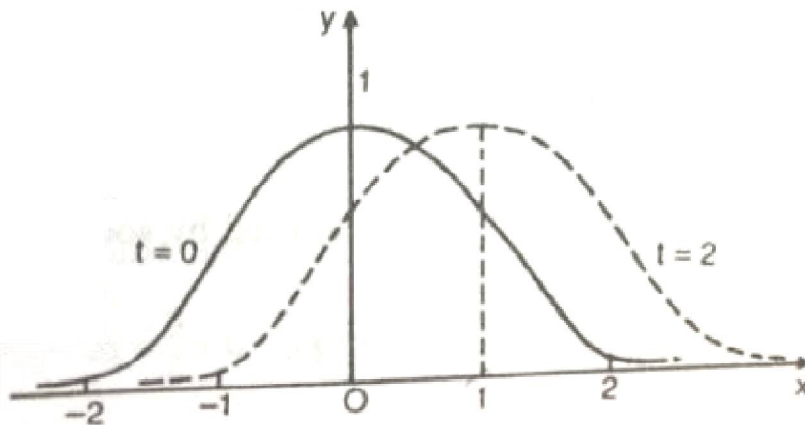

Obviously the wave advances by 1 m in 2 s.

$$\therefore V = \frac{1}{2} = 0.5 \text{ m/s.}$$

The following equations represent transverse waves:  $z_1 = A \cos(kx - \omega t)$ ,  $z_2 = A \cos(kx + \omega t)$ ,  $z_3 = A \cos(ky - \omega t)$ . Identify the combination (s) of the waves which will produce (i) standing waves (s), (ii) a wave travelling in the direction making an angle of  $45^\circ$  with the positive  $x$  and positive  $y$ -axes. In each case find the positions at which the resultant intensity is always zero. [IIT 1987]

The first and the second equations represent waves travelling in opposite directions along  $x$ -axis. Hence they combine to form stationary waves.

$$z = z_1 + z_2 = A \cos (kx - \omega t) + A \cos (kx + \omega t).$$

This is equation of stationary waves. The intensity is zero when  $\cos kx = 0$

or  $kx = (2S + 1) \frac{\pi}{2}$  where  $S =$  any integer including zero

or  $x = \frac{(2S + 1)\pi}{2k}$ .

The resultant of 1 and 3 is given by

$$\begin{aligned} z &= z_1 + z_3 = A \cos (kx - \omega t) + A \cos (ky - \omega t) \\ &= 2A \cos \left[ \frac{1}{2}k(x + y) - \omega t \right] \cos \frac{1}{2}k(x - y) \end{aligned}$$



or 
$$z = 2A \cos \frac{1}{2} k(x - y) \cos \left( \frac{1}{2} k(x + y) - \omega t \right). \quad \dots (i)$$

The most general equation of a wave is

$$z = C \cos (\vec{k} \cdot \vec{r} - \omega t)$$

where  $C$  is a constant representing amplitude of the wave,  $\vec{k}$  is the wave vector and  $\vec{r}$  is the position vector of the point in space through which wave is travelling.

The equation of a wave travelling along  $45^\circ$  with  $x$ - and  $y$ - axes in the  $xy$  plane is given by 
$$z = C \cos [k(x + y) - \omega t]. \quad \dots (ii)$$

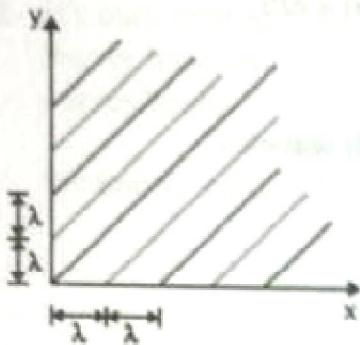

Fig. 1.2

Comparing the two equations we find that (i) represents a travelling wave of wave vector  $\frac{k}{2}$  along  $45^\circ$  inclination with  $x$ - and  $y$ - axes. The amplitude of the wave is proportional to  $\cos \frac{1}{2} k(x - y)$ .

Hence intensity is zero at positions

$$\frac{1}{2} k(x - y) = \pm (2S + 1) \frac{\pi}{2}$$

or 
$$x = y \pm \frac{(2S + 1) \pi}{k}.$$

The particles of the medium at the points on the dotted lines will have no motion and hence intensity will be zero along these lines.

### Beats of Beats

Three sound waves of frequencies 320, 344 and 280 are produced simultaneously. Find the number of beats per second, assuming the human ear's resolution is 10 beats per second.

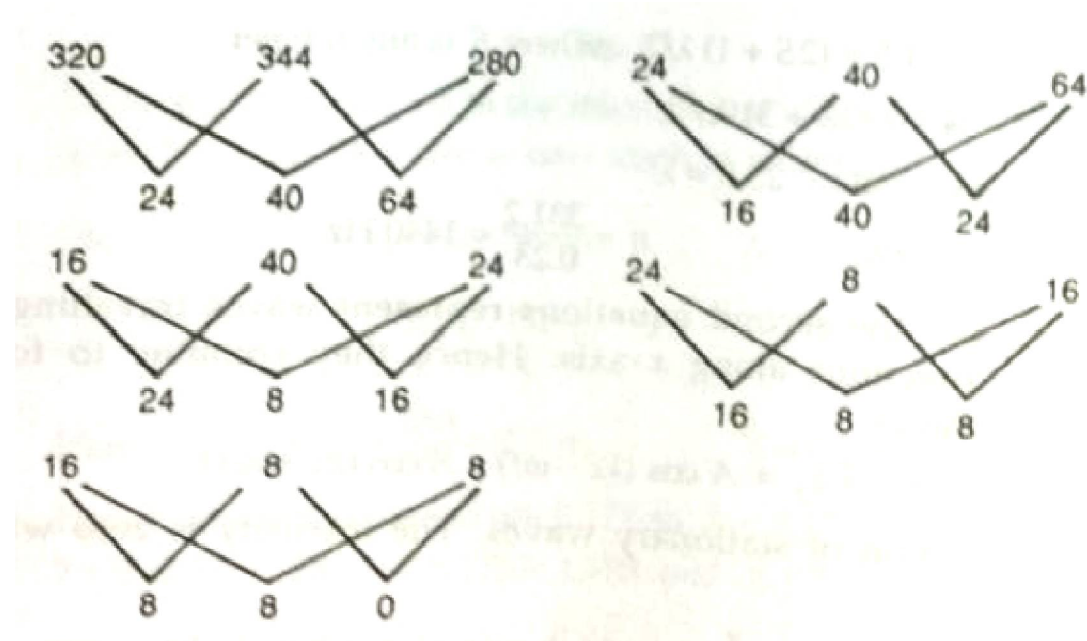

Question

One end of a rope is tied to a peg on the wall. The other free end is held taut by the hand and periodically shaken. A wave travels down the rope sinusoidally with frequency  $2.0 \text{ Hz}$  and amplitude  $7.5 \text{ cm}$ . The wave speed is  $12.0 \text{ m s}^{-1}$ . Find the angular frequency, period, wavelength and wave number of the wave. Write the equation for the displacement as a function of time.

## ***Solution***

$$\text{Angular frequency } \omega = 2\pi f = 4\pi \text{ rad s}^{-1} = 12.6 \text{ rad s}^{-1}$$

$$\text{Time period } T = \frac{1}{f} = 0.5 \text{ s}$$

$$\text{wavelength } \lambda = \frac{v}{f} = 12.0 \times 0.5 = 6.0 \text{ m}$$

$$\text{wave number } k = \frac{2\pi}{\lambda} = \frac{2\pi}{6} = 1.05 \text{ rad m}^{-1}$$

$$y = A \sin(kx - \omega t) = (0.075 \text{ m}) \sin[(1.05 \text{ rad m}^{-1}x - (12.6 \text{ rad s}^{-1})t)]$$

## ***Power of a wave (P)***

The energy contained in a volume element of the medium in unit time is called the power of the wave. Energy contained in an element of length ' $\Delta x$ ' and area of cross section ' $a$ ' in a time ' $\Delta t$ ' will be  $E = U a \Delta x$

$$\therefore \text{ Power of the wave } P = \frac{E}{\Delta t} = \frac{ua\Delta x}{\Delta t}$$

$$P = Uav = 2\pi^2 f^2 A^2 \rho av$$

$$(\because \text{ wave velocity, } v = \frac{\Delta x}{\Delta t})$$

## ***Intensity of a wave (I)***

**Intensity of a wave is defined as the energy transferred in unit time or power transmitted across unit area held perpendicular to the direction of propagation of the wave. SI unit of intensity is  $W m^{-2}$ .**

$$I = \frac{P}{a} = Uv$$
$$= 2\pi^2 f^2 A^2 \rho v. \text{ Therefore,}$$

**Intensity of a wave = Energy density of the wave  $\times$  speed of the wave**

**Hence, intensity of a wave is directly proportional to**

- (i) the square of its amplitude,**
- (ii) the square of its frequency,**
- (iii) the velocity of propagation and**
- (iv) the density of the medium through which it travels.**

Question

**In Concept Strand 7, calculate the intensity of the wave, if the linear density of the rope is  $250 g m^{-1}$ .**

## Solution

$$I = \frac{1}{2} \omega^2 A^2 \rho v = \frac{1}{2} (12.6 \text{ rad s}^{-1})^2 (0.075 \text{ m})^2 (0.25 \text{ kg m}^{-1}) (12 \text{ m s}^{-1})$$

$$= 1.34 \text{ W}$$

## Question

Two waves traveling in the positive x-direction having same amplitude, same frequency, same speed and phase difference of  $\pi/2$  between them superimpose. Find the expression for the resultant wave and sketch the profile of the resultant wave at any instant.

By formula, the amplitude of the resultant wave

$$= \sqrt{A^2 + A^2 + 2A^2 \cos\left(\frac{\pi}{2}\right)} = \sqrt{2}A$$

$$\text{Phase of the resultant wave} = \tan^{-1}\left(\frac{A \sin \frac{\pi}{2}}{A + A \cos \frac{\pi}{2}}\right)$$

$$= \frac{\pi}{4} \text{ radian}$$

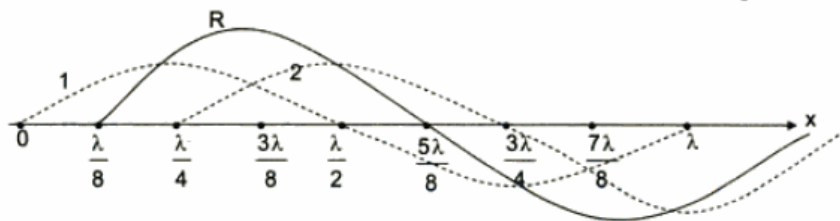

1 and 2 are the component waves and R is the resultant.

We know that the intensity of a wave  $I$  is proportional to square of amplitude ( $A$ ) and square of frequency ( $f$ ).

i.e.,  $I \propto A^2 f^2$

or

$$I_{\min} = (\sqrt{I_1} - \sqrt{I_2})^2$$

This is called destructive interference. If  $\cos \delta = 0$ , then

Hence, for waves of the same frequency,  $I \propto A^2$

$$\Rightarrow I = pA^2, I_1 = pA_1^2 \text{ and } I_2 = pA_2^2$$

where  $p$  = constant of proportionality  $pA^2 = pA_1^2 + pA_2^2 + 2pA_1A_2\cos\delta$  (by multiplying the amplitude of resultant wave with  $p$ )

$$\text{i.e., } I = I_1 + I_2 + 2\sqrt{I_1I_2}\cos\delta$$

is the resultant intensity of the superimposed waves.

The term  $2\sqrt{I_1I_2}\cos\delta$  in the resultant intensity expression is called the *Interference factor*. The magnitude and sign (positive or negative) of the interference factor depends upon  $\delta$  (the phase difference with which the waves superimpose at a point in the medium). Maximum intensity ( $I_{\max}$ ) occurs when  $\cos\delta = 1$ . Therefore,

$$I_{\max} = I_1 + I_2 + 2\sqrt{I_1I_2}$$

or

$$I_{\max} = \left[ \sqrt{I_1} + \sqrt{I_2} \right]^2$$

This is called *constructive interference*

Minimum intensity ( $I_{\min}$ ) occurs, when  $\cos\delta = -1$ . Therefore,

$$I_{\min} = I_1 + I_2 - 2\sqrt{I_1I_2}$$

$$I = I_1 + I_2.$$

The phenomenon of interference is based on the law of conservation of energy. There is no loss of energy in interference. Energy which disappears in regions of minimum intensity appears in regions of maximum intensity.

When waves produced by non-coherent sources superimpose, the resultant intensity is the sum of the intensities of the individual waves. i.e.,  $I = I_1 + I_2$ . Interference factor  $2\sqrt{I_1I_2}\cos\phi = 0$  for non-coherent waves, because  $\phi$  can have all values and average value of  $\cos\phi$  is zero.

Interference phenomenon can occur in transverse waves as well as longitudinal waves. It can also occur in mechanical waves and electromagnetic waves (Example, light). Two separate lamps of same frequency can never produce interference, as they are not coherent sources. Production of light is an atomic phenomenon (microscopic property of matter) and there is no constant phase relationship between the light produced by different sources.

However, two separate sources of sound of same fre-

quency may produce interference phenomenon because propagation of sound through a medium is a bulk property of the medium (macroscopic property of matter) and such sources of sound could be coherent sources.

## Question

**A string fixed at its ends is 70 cm long. The speed of transverse wave through it is  $49 \text{ m s}^{-1}$ . If the string is vibrating in seven identical segments**

- (i) How many nodes and antinodes are present in its vibration?
- (ii) What is the wavelength of the wave?
- (iii) What is the frequency of vibration?
- (iv) What is the fundamental frequency and wavelength of fundamental vibration of the string?
- (v) What is the wavelength and frequency in the second overtone?
- (vi) What is the wavelength and frequency in the fourth mode of vibration?

Length of string,  $L = 70 \text{ cm} = 0.7 \text{ m}$

Speed of transverse wave,  $v = 49 \text{ m s}^{-1}$

Number of segments = mode of vibration of the string

$n = 7$

(i) Number of antinodes = mode of vibration  $n = 7$

Number of nodes =  $n + 1 = 7 + 1 = 8$

(ii) The wavelength of the wave,  $\lambda_n = \frac{2L}{n}$

$$\therefore \text{Wavelength } \lambda_n = \frac{2 \times 0.7}{7} = 0.2 \text{ m}$$

(iii) The frequency of vibration,

$$f_n = \frac{nv}{2L}$$

$$\therefore f_n = \frac{7 \times 49}{2 \times 0.7} = 245 \text{ Hz}$$

(iv)  $f_n = n f_1$ ,

Hence the fundamental frequency of string,  $f_1 =$

$$\frac{f_n}{n} = \frac{245}{7} = 35 \text{ Hz} \text{ wavelength of the fundamental}$$

$$\text{mode, } \lambda_1 = \frac{v}{f_1} = \frac{49}{35} = 1.4 \text{ m}$$

(Alternatively

$$f_1 = \frac{nv}{2L} = \frac{1 \times 49}{2 \times 0.7} = 35 \text{ Hz}$$

$$\lambda_1 = \frac{2L}{n} = \frac{2 \times 0.7}{1} = 1.4 \text{ m}$$

(v) In the second overtone, the mode of vibration is

$$n = 3$$

$$\lambda_n = \frac{2L}{n} \text{ and}$$

$$f_n = nf_1$$

$$\lambda_3 = \frac{2 \times 0.7}{3} = 0.467 \text{ m}$$

The frequency of the second overtone,

$$f_3 = 3 f_1 = 3 \times 35 \\ = 105 \text{ Hz}$$

(vi) In the fourth mode of vibration,  $n = 4$ .

Frequency in the fourth mode of vibration,

$$f_4 = 4f_1 = 4 \times 35 = 140 \text{ Hz}$$

The wavelength of wave in the fourth mode,

$$\lambda_4 = \frac{2L}{n} = \frac{2 \times 0.7}{4} = 0.35 \text{ m}$$



Question

The air column in a closed pipe of length 40 cm and diameter 2.5 cm is set into vibration. What is the frequency of vibration if it is vibrating in its first mode? Velocity of sound in air  $v = 340 \text{ m s}^{-1}$

### ***Solution***

Diameter of pipe = 2.5 cm = 0.025 m

End correction  $e = 0.3 d = 0.3 \times 0.025 = 0.0075 \text{ m}$

Length of the pipe  $L = 40 \text{ cm} = 0.40 \text{ m}$ .

Frequency of vibration in the first mode

$$= \text{fundamental frequency, } f_1 = \frac{v}{4(L + e)}$$

$$= \frac{340}{4(0.40 + 0.0075)}$$

$$= \frac{340}{4 \times 0.4075}$$

$$= 208.59 \text{ Hz}$$

Question

**A train moving at a speed of 72 kmph sounds a whistle of frequency 500 Hz. Calculate the apparent frequency of the whistle as heard by a man on the platform when the train (i) approaches him and (ii) recedes from him. Given speed of sound =  $340 \text{ m s}^{-1}$ .**

### ***Solution***

Velocity of sound  $v = 340 \text{ m s}^{-1}$

Velocity of source  $v_s = 72 \text{ kmph}$

$$= \frac{72 \times 5}{18} = 20 \text{ m s}^{-1}$$

(i) **Apparent frequency of sound as heard by the listener.**

$$f' = f \frac{(v - v_L)}{(v - v_s)}$$

**The train is approaching a stationary listener,**

$$v_L = 0, v_s = + 20 \text{ m s}^{-1}$$

$$v = 340 \text{ m s}^{-1}, f = 500 \text{ Hz}$$

$$f' = f \frac{(v - v_L)}{(v - v_s)}$$

$$f' = \frac{500(340 - 0)}{(340 - 20)} = \frac{500 \times 340}{320} = 531.25 \text{ Hz}$$

**(ii) The train is receding from a stationary listener.**

$$v_L = 0, v_s = 20 \text{ m s}^{-1}$$

$$v = 340 \text{ m s}^{-1}, f = 500 \text{ Hz}$$

$$f' = f \frac{(v - v_L)}{(v + v_s)}$$

$$f' = \frac{500(340 - 0)}{(340 + 20)} = \frac{500 \times 340}{360} = 472.2 \text{ Hz}$$

Question

**Find (i) the intensity level corresponding to sound intensity of  $10^{-8} \text{ W m}^{-2}$  and (ii) the intensity of sound of intensity level 50 dB. Given threshold of hearing =  $10^{-12} \text{ W m}^{-2}$ .**

### ***Solution***

(i) Sound intensity  $I = 10^{-8} \text{ W m}^{-2}$

Threshold of hearing  $I_0 = 10^{-12} \text{ W m}^{-2}$

$$\text{Intensity level } I_L = 10 \log \left( \frac{I}{I_0} \right),$$

$$\text{dB} = 10 \log \left( \frac{10^{-8}}{10^{-12}} \right) = 10 \log 10^4 = 40 \text{ dB}$$

(ii) Intensity level  $I_L = 50 \text{ dB}$

Intensity of sound =  $I$

$$I_0 = 10^{-12} \text{ W m}^{-2}$$

$$I_L = 10 \log \left( \frac{I}{I_0} \right) \text{ dB}$$

$$50 = 10 \log \left( \frac{I}{I_0} \right)$$

$$\log \left( \frac{I}{I_0} \right) = 5, \frac{I}{I_0} = 10^5$$

$$I = 10^5 I_0, I = 10^5 \times 10^{-12}$$

$$\text{i.e., } I = 10^{-7} \text{ W m}^{-2}$$

### Question

1. The displacement wave in a string is  $y = (3 \text{ cm}) \sin 6.28(0.5x - 50t)$  where  $x$  is in centimetres and  $t$  in seconds. The wavelength and velocity of the wave is
- (a) 2 cm, 100  $\text{cm s}^{-1}$                       (b) 10 cm, 50  $\text{cm}^{-1}$   
(c) 20 cm, 2  $\text{ms}^{-1}$                         (d) 2 m, 100  $\text{ms}^{-1}$

**Solution** (a)  $k = \frac{2\pi}{\lambda}$

or  $\lambda = \frac{2\pi}{k} = \frac{6.28}{6.28(0.5)} = 2 \text{ cm}$

$$v = \frac{\omega}{k} = \frac{50 \times 6.28}{0.5 \times 6.28} = 100 \text{ cm s}^{-1}$$

### Question

2. The equation of a wave is  $10 \sin(6.28x - 314t)$  where  $x$  is in centimetres and  $t$  is in seconds. The maximum velocity of the particle is
- (a) 62.8  $\text{cm s}^{-1}$                               (b) 3140  $\text{ms}^{-1}$   
(c) 50  $\text{cm s}^{-1}$                                 (d) 31.4  $\text{m s}^{-1}$

**Solution** (d)  $y_{\text{max}} = \omega y_0 = 314(10) \text{ cm/s}$  or  $31.4 \text{ ms}^{-1}$

3. The speed of a transverse wave travelling on a wire having a length 50 cm and mass 50 g is  $80 \text{ ms}^{-1}$ . The area of cross-section of the wire is  $1 \text{ mm}^2$  and its Young's modulus is  $16 \times 10^{11} \text{ Nm}^{-2}$ . Find the extension of the wire over natural length.
- (a) 2 cm    (b) 2 mm  
(c) 0.2 mm                                        (d) 0.02 mm

**Solution** (d)  $v = \sqrt{\frac{T}{\mu}}$

or  $T = v^2\mu = (80)^2 \left( \frac{5}{0.5} \times 10^{-3} \right) = 64 \text{ N}$

and  $Y = \frac{Fl}{A \Delta l}$

or  $\Delta l = \frac{Fl}{AY} = \frac{64 \times 0.5}{10^{-6} \times 16 \times 10^{11}} = 2 \times 10^{-3} \text{ m.}$

4. Which of the following waves is progressing in the  $y$  direction?

- (a)  $x = x_0 \cos(\omega t - ky)$       (b)  $y = y_0 \cos(\omega t - ky)$   
(c)  $y = y_0 \cos kx \sin \omega t$       (d)  $y = y_0 \sin kx \cos \omega t$

**Solution** (a) The wave  $x = x_0 \cos(\omega t - ky)$  travels along  $y$  direction.

5. Velocity of sound in air is 332 m/s. Its velocity in vacuum is

- (a)  $> 332 \text{ ms}^{-1}$       (b)  $3 \times 10^8 \text{ ms}^{-1}$   
(c)  $332 \text{ ms}^{-1}$       (d) none of these

**Solution** (d) None of these as velocity is zero as sound waves require medium.

6. A cork floating in a calm lake is executing SHM of frequency  $f$ . When a boat passes close to the cork then the

- (a) frequency becomes greater than  $f$ .  
(b) frequency becomes less than  $f$ .  
(c) frequency remains constant.  
(d) none of these.

**Solution** (c) Frequency remains constant and velocity will vary, that is, wavelength will vary.

7. Two waves of equal amplitude  $x_0$  and equal frequency travel in the same direction in a medium. The amplitude of the resultant wave is

- (a) 0 (b)  $x_0$   
(c)  $2x_0$  (d) between 0 and  $2x_0$

**Solution** (d) use  $x_0' = \sqrt{x_{01}^2 + x_{02}^2 + 2x_{01}x_{02} \cos \theta}$

$\therefore \theta = 0$  and  $x_{01} = x_{02} = x_0$

$$x_0' = 2x_0.$$

8. The fundamental frequency of a string is proportional to

- (a) inverse of the length. (b) the diameter.  
(c) tension. (d) density.

**Solution** (a)  $f \propto \frac{1}{l}$

9. A uniform rope of length 12 m and mass 6 kg hangs vertically from a rigid support. A block of mass 2 kg is attached to the free end of the rope. A transverse pulse of wavelength 0.06 m is produced at the lower end of the rope. What is the wavelength of the pulse when it reaches the top of the rope.

- (a) 0.06 m (b) 0.12 m  
(c) 0.09 m (d) none of these

[IIT 1984]

**Solution** (d)  $v = \frac{T}{\mu}$

$$\frac{v_{top}}{v_{bottom}} = \sqrt{\frac{T_T}{T_B}} = \sqrt{\frac{(6+2)g}{2g}} = 2$$

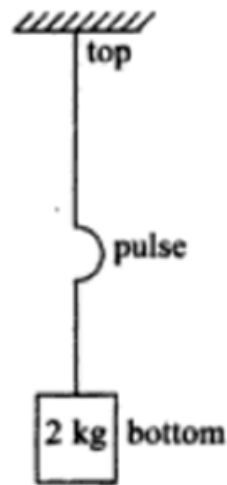

$$\frac{f\lambda_{\text{Top}}}{f\lambda_{\text{Bottom}}} = 2 \text{ as frequency does not change}$$

$$\therefore \lambda_{\text{top}} = \lambda_{\text{bot}} \times 2 = 0.12 \text{ m.}$$

- 10.** A uniform rope of mass 0.1 kg and length 2.45 m hangs from a ceiling. The speed of transverse waves in the rope at a point 0.5 m from the lower end is
- (a)  $2.21 \text{ ms}^{-1}$                       (b)  $4.21 \text{ ms}^{-1}$   
(c)  $7.21 \text{ ms}^{-1}$                       (d)  $3.31 \text{ ms}^{-1}$



**Solution** (a)  $T = \frac{M}{L} (x)g$

and  $v = \sqrt{\frac{\frac{M}{L} (x)g}{M/L}} = \sqrt{gx} = \sqrt{9.8 \times 0.5}$   
 $= 2.21 \text{ m/s}$

11. The equations of motion of two waves propagating in the same direction is given by

$$y_1 = A \sin(\omega t - kx)$$

and  $y_2 = A \sin(\omega t - kx - \theta).$

The amplitude of the medium particle will be

(a)  $\sqrt{2} A \cos \theta$

(b)  $2A \cos \theta$

(c)  $\sqrt{2} A \cos \theta/2$

(d)  $2A \cos \theta/2$



**13. A steel wire of linear mass density 9.8 g/m is stretched with a tension of 10 kg. It is kept between poles of an electromagnet and it vibrates in resonance when carrying an arc of frequency  $n$ . The frequency  $n$  is**

(a) 100 Hz

(b) 200 Hz

(c) 25 Hz

(d) 50 Hz

**Solution** (d)  $f = \frac{1}{2l} \sqrt{\frac{T}{\mu}} = \frac{1}{2} \sqrt{\frac{10 \times 9.8}{9.8 \times 10^{-3}}}$

$$= \frac{10^2}{2} = 50 \text{ Hz.}$$

**14. The equation of a progressive wave is**

$$y = 8 \sin \left[ \pi \left( \frac{t}{10} - \frac{x}{4} \right) + \frac{\pi}{3} \right]. \text{ The wavelength}$$

**of the wave is**

(a) 8 m

(b) 4 m

(c) 2 m

(d) 10 m

**Solution** (a)  $\frac{2\pi}{\lambda} = k$  or  $\lambda = \frac{2\pi}{k} = \frac{2\pi}{\pi/4} = 8$

15. The equation of a stationary wave is  $y = \sin \frac{\pi x}{3} \cos 10\pi t$  where  $x$  and  $y$  are in centimetres and  $t$  in seconds. The separation between two consecutive nodes is

(a) 1.5 cm

(b) 6.0 cm

(c) 3.0 cm

(d) 18 cm

**Solution** (c)  $\lambda = \frac{2\pi}{k} = \frac{2\pi}{\pi/3} = 6$  cm.

Separation between two consecutive nodes  
 $= \lambda/2 = 3$  cm.



17. An observer on the sea shore observes 54 waves reaching the coast per minute. If the wavelength is 10 m. The velocity is

- (a)  $9 \text{ ms}^{-1}$  (b)  $54 \text{ ms}^{-1}$   
(c)  $18 \text{ ms}^{-1}$  (d)  $36 \text{ ms}^{-1}$

**Solution** (a)  $f = \frac{54}{60} = \frac{9}{10} \text{ Hz}$

$$v = f\lambda = \frac{9}{10} \times 10 = 9 \text{ ms}^{-1}$$

18. A light pointer fixed to one prong of a tuning fork touches a vertical smoked plate. The fork is set to vibration and the plate is allowed to fall freely. Eight

complete waves are counted when the plate falls through 10 cm. The frequency of the tuning fork is

- (a) 112 Hz (b) 14 Hz  
(c) 28 Hz (d) 56 Hz

[IIT 1996]

**Solution** (d)  $t = \sqrt{\frac{2h}{g}} = \sqrt{\frac{2 \times 0.1}{9.8}} = \frac{1}{7} \text{ s.}$

$$f = \frac{\text{number of waves}}{\text{time}} = \frac{8}{1/7} = 56 \text{ Hz.}$$

**19.** A progressive wave of frequency 500 Hz is travelling with a velocity  $360 \text{ ms}^{-1}$ . How far are two points  $60^\circ$  out of phase?

(a) 0.06 m

(b) 0.12 m

(c) 0.18 m

(d) 0.24 m

**Solution** (b)  $\lambda = \frac{v}{f} = \frac{360}{500} = 0.72 \text{ m}$

$$\Delta\phi = \frac{2\pi}{\lambda} (\Delta x)$$

or  $\Delta x = \frac{\Delta\phi\lambda}{2\pi} = \frac{\pi/3(0.72)}{2\pi} = 0.12 \text{ m}$

20 )

Two blocks each having a mass 3.2 kg are connected by a wire  $CD$  and the system is suspended from the ceiling by another wire  $AB$  as shown in figure. The linear mass density of  $AB$  is  $10 \text{ gm}^{-1}$  and that of the  $CD$  is  $8 \text{ gm}^{-1}$ . The speed of the transverse wave pulse produced in  $AB$  and  $CD$  is

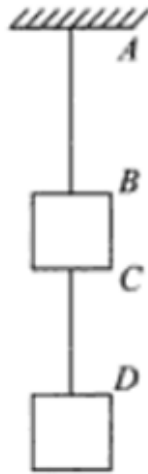

- (a)  $80 \text{ ms}^{-1}$ ,  $40 \text{ ms}^{-1}$                       (b)  $40 \text{ ms}^{-1}$ ,  $80 \text{ ms}^{-1}$   
(c)  $80 \text{ ms}^{-1}$ ,  $63 \text{ ms}^{-1}$                       (d) none of these

**Solution**      (c)  $v = \sqrt{\frac{T}{\mu}} \Rightarrow v_{AB}$

$$= \sqrt{\frac{6.4 \times 10}{10 \times 10^{-3}}} = 80 \text{ ms}^{-1}$$

$$v_{CD} = \sqrt{\frac{3.2 \times 10}{8 \times 10^{-3}}} = 63 \text{ ms}^{-1}$$





**Solution** 1. (a)  $v = \sqrt{\frac{T}{\mu}} \Rightarrow \frac{3}{0.2} = \sqrt{\frac{T}{.1}}$

or  $3 T = 22.5 N$   
or  $T = 7.5 N$

**Solution** 2. (a)  $f = \frac{n_1}{2l} \sqrt{\frac{T}{.01}} = \frac{n_2}{2l} \sqrt{\frac{T}{.09}}$

or  $\frac{n_1}{n_2} = \frac{1}{3}$

**Solution** 3. (d)  $f = \frac{1}{3} \sqrt{\frac{7.5 \times 1.5}{.01}} = \sqrt{125} = 11.1 \text{ Hz.}$

## Question

A boy of 5th standard is playing with the cloths line. He unties one end, holds it taut and wiggles the end up and down sinusoidlly with frequency 2 Hz and amplitude 0.075 m. The wave speed is  $12 \text{ ms}^{-1}$ . At  $t = 0$  the end has maximum displacement and is instantaneously at rest. Assume no wave bounces back from the far end to muddle up the pattern.

- What is wave number?
  - $1.05 \text{ m}^{-1}$
  - $1.32 \text{ m}^{-1}$
  - $0.78 \text{ m}^{-1}$
  - $2.34 \text{ m}^{-1}$
- Write a wave function describing the wave.
  - $y = 0.075 \cos (1.05x - 4\pi t)$
  - $y = 0.075 \cos (1.05x - 2t)$
  - $y = 0.075 \sin (1.05x - 4\pi t)$
  - $y = 0.075 \sin (1.05x - 2t)$
- Write equations for the displacement as a function of time 3 m of the boy's end of the clothesline
  - $y = 0.075 \cos 4\pi$
  - $y = (-0.075 \cos 4\pi)$
  - $y = 0.075 \sin 4\pi$
  - none

**Solution** 1. (a)  $v = \frac{\omega}{k}$

or  $k = \frac{\omega}{v} = \frac{2\pi \times 2}{12} = \frac{\pi}{3} = 1.05 \text{ m}^{-1}$ .

**Solution** 2. (a)

**Solution** 3. (b)  $y = y_0 \cos 2\pi \left( \frac{x}{\lambda} - \frac{t}{T} \right) = 0.075 \cos 2\pi$

$$\left( \frac{3}{6} - 2t \right)$$

$\therefore \lambda = \frac{v}{f} = \frac{12}{2} = 6 \text{ m.}$   
 $= 0.075 \cos (\pi - 4\pi t)$   
 $= -0.075 \cos 4\pi t$

**Read the following passage and answer the questions given at the end.**

One of the strings of a Guitar lies along the  $x$ -axis when in equilibrium. The end of the string at  $x = 0$  (the bridge of the guitar) is tied down. An incident sinusoidal wave travels the string in the  $-x$  direction at  $143 \text{ ms}^{-1}$  with an amplitude  $0.75 \text{ mm}$  and a frequency of  $440 \text{ Hz}$ . This wave is reflected from the  $x = 0$  end (fixed end) and the super position of incident and reflected travelling waves forms a standing wave.

- The equation of the wave representing stationary wave is
  - $0.75 \sin 19.3x \cos 880\pi t.$
  - $(0.75 \times 10^{-3}) \sin 19.3x \cos 880\pi t.$
  - $1.5 \times 10^{-3} \sin 19.3x \cos 880\pi t.$
  - $1.50 \times 10^{-3} \sin 19.3x \cos 440\pi t.$
- The separation between the two nearest points on the string that donot move at all is
  - $0.163 \text{ m}$
  - $0.325 \text{ m}$
  - $0.202 \text{ m}$
  - $0.244 \text{ m}$
  - none

**3. The maximum transverse velocity and maximum transverse acceleration at point of maximum oscillation is**

- (a)  $4.15 \text{ ms}^{-1}, 1.15 \times 10^4 \text{ ms}^{-2}$
- (b)  $4.15 \text{ ms}^{-1}, -1.15 \times 10^4 \text{ ms}^{-2}$
- (c)  $1.15 \text{ ms}^{-1}, 4.15 \times 10^4 \text{ ms}^{-2}$
- (d)  $3.98 \text{ ms}^{-1}, 1.35 \times 10^4 \text{ ms}^{-2}$

**Solution** 1. (c)  $y = 2y_0 \sin kx \cos \omega t = 1.5 \times 10^{-3} \sin$

$$\left( \frac{440 \times 2\pi}{143} x \right) \cos (440 \times 2\pi)t$$

**Solution** 2. (a)  $l = \frac{\lambda}{2} = \frac{143}{2 \times 440} = 0.163 \text{ m.}$

**Solution** 3. (a)  $v_{\max} = \left. \frac{\partial y}{\partial t} \right|_{\max} = 1.5 \times 10^{-3} \times 2760 \sin 19.3x$

$$\cos 880\pi t \Big|_{\max} = 4.15 \text{ ms}^{-1}$$

$$a_{\max} = \left. \frac{\partial^2 y}{\partial t^2} \right|_{\max} = 4.15 \times 2760 = 1.15 \times 10^4 \text{ ms}^{-2}$$

Question

Two open pipes of length 50 cm and 51 cm produce 6 beats when sounded together, find the speed of sound.

(a)  $330 \text{ ms}^{-1}$

(b)  $316 \text{ ms}^{-1}$

(c)  $306 \text{ ms}^{-1}$

(d)  $360 \text{ ms}^{-1}$

**Solution** (c)  $f_1 - f_2 = 6$  or  $\frac{v}{2l_1} - \frac{v}{2l_2} = 6$

$$\frac{v}{2(0.5)} - \frac{v}{2(0.51)} = 6 \text{ or } v = 306 \text{ ms}^{-1}.$$

Question

If fundamental frequency of an open pipe is  $f_0$ . Its fundamental frequency when it is half-filled with water is

(a)  $f_0$

(b)  $\frac{\lambda}{4}$

(c)  $2f_0$

(d) none of these

**Solution** (a) See the situation shown in the Fig.

When the pipe is half-filled with water it becomes a closed pipe and the length.

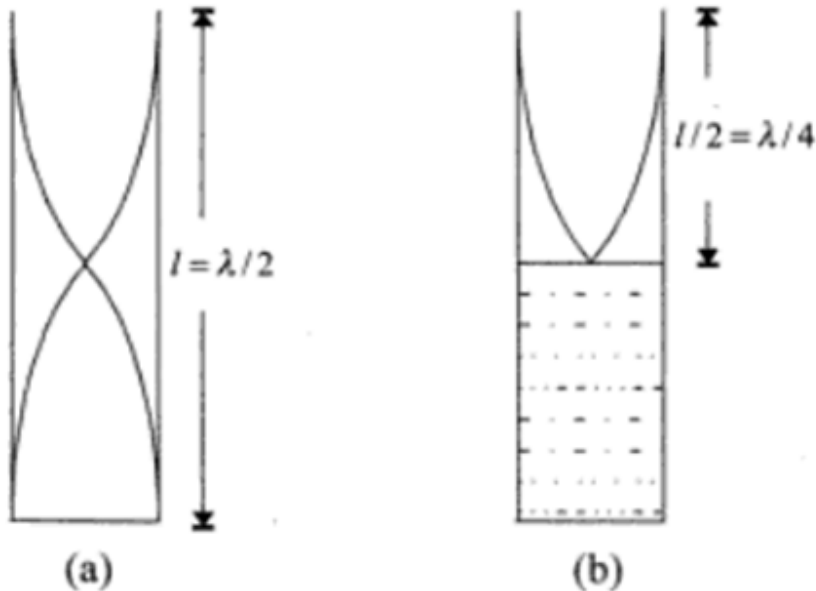

**Fig.**

$$\frac{l}{2} = \frac{\lambda}{4} \text{ or } \lambda = 2l$$

same wavelength existed in open pipe. Therefore, frequency remains unchanged as  $f = \frac{v}{\lambda}$ .

Question

**In the experiment for determination of the speed of sound in air using resonance tube method. The length of air column that resonates with fundamental mode**

with a tuning fork is 0.1 m. When its length is changed to 0.35 m it resonates in first overtone. The end correction is

(a) 0.012 m

(b) 0.025 m

(c) 0.05 m

(d) 0.0024 m

**Solution** (b)  $l_1 + 0.3 d = \frac{\lambda}{4}$ ,  $l_2 + 0.3 d = \frac{3\lambda}{4}$  ;

$$\frac{\lambda}{2} = l_2 - l_1 = 0.25 \text{ m or } \frac{\lambda}{4} = 0.125 \text{ m}$$

$$0.3 d = \frac{\lambda}{4} - l_1 = 0.025 \text{ m}$$

Question

An observer moves towards a stationary source of sound with one-fifth of the speed of sound. The wavelength and frequency of the source emitted are  $\lambda$  and  $f$  respectively. The apparent frequency and wavelength recorded by the observer are

(a)  $0.85f, 0.8 \lambda$

(b)  $1.2f, 1.2 \lambda$

(c)  $1.2f, \lambda$

(d)  $f, 1.2 \lambda$



**Solution** (c)  $f_{app} = \frac{v+v/5}{v} f = 1.2f$  wavelength remains unchanged.

Question

An air column closed at one end and open at the other end resonates with a tuning fork when 45 and 99 cm of length. The wavelength of the sound in air column is

- (a) 36 cm (b) 54 cm  
(c) 108 cm (d) 180 cm

**Solution** (c)  $\frac{\lambda}{2} = 99 - 45 = 54 \text{ cm}$

or  $\lambda = 108 \text{ cm}$

Question

The frequency of a tuning fork is 384 Hz and velocity of sound in air is  $352 \text{ ms}^{-1}$ . How far sound has travelled when fork completes 36 vibration?

- (a) 33 m (b) 16.5 m  
(c) 11 m (d) 22 m

**Solution** (a)  $x = v \cdot t = 352 \times \frac{36}{384} = 33 \text{ m.}$

Question

A sound source is falling under gravity. At some time  $t = 0$  the detector lies vertically below source at a height  $H$  as shown in Fig. If  $v$  is velocity of sound and  $f_0$  is frequency of the source then the apparent frequency recorded after  $t = 2$  second is



Question

An open pipe is suddenly closed at one end. As a result the frequency of third harmonic of the closed pipe is found to be higher by 100 Hz. The fundamental frequency of open pipe is

(a) 200 Hz

(b) 30 Hz

(c) 240 Hz

(d) 480 Hz

[IIT 1996]

**Solution** (a)  $f_{0(\text{closed})} = \frac{v}{\lambda} = \frac{v}{4l}$

third harmonic of closed pipe =  $3f_{0(\text{closed})} = \frac{3v}{4l}$

$$\frac{3v}{4l} - \frac{v}{2l} = 100 \text{ or } \frac{v}{4l} = 100 \text{ and}$$

$$f_{0(\text{open})} = \frac{v}{2l}$$

$$\frac{v}{2l} = 200.$$

### Question

As a wave propagates

- (a) the wave intensity remains constant for a plane wave.
- (b) the wave intensity decreases as the inverse of the distance from source for a spherical wave.
- (c) the wave intensity falls as the inverse square of the distance from a spherical wave.
- (d) total intensity of the spherical wave over the spherical surface centred at the source remains constant at all times.

Solution a, c, d

### Question

Two monatomic ideal gases 1 and 2 of molecular masses  $m_1$  and  $m_2$  respectively are enclosed in separate containers kept at the same temperature. The ratio of the speed of sound in gas 1 to gas 2 is given by

- (a)  $\frac{m_1}{m_2}$
- (b)  $\sqrt{\frac{m_1}{m_2}}$
- (c)  $\frac{m_2}{m_1}$
- (d)  $\sqrt{\frac{m_2}{m_1}}$

[IIT 2000]

**Solution** (d) As  $v = \sqrt{\frac{\gamma RT}{M}} \therefore \frac{v_1}{v_2} = \sqrt{\frac{m_2}{m_1}}$

Question

A siren placed at a railway platform is emitting sound of frequency 5 kHz. A passenger sitting in a moving train *A* records a frequency of 5.5 kHz when the train approaches the siren. During his return journey in a different train *B* he records the frequency of 6 kHz while approaching the same siren. The ratio of velocity of train *B* to train *A* is

(a)  $\frac{242}{252}$

(b)  $\frac{5}{6}$

(c) 2

(d)  $\frac{11}{6}$

[IIT screening 2002]

**Solution** (c)  $\left(\frac{v+v_{L1}}{v}\right)5 = 5.5, \left(\frac{v+v_{L2}}{v}\right)5 = 6$

or  $\frac{v_{L1}}{v} = 0.5$  or  $\frac{v_{L2}}{v} = 1$  or  $\frac{v_{L2}}{v_{L1}} = 2$

Question

A piezo electric quartz crystal of thickness 0.005 m is vibrating in resonate conditions. Calculate the fundamental frequency  $f_0$  for quartz.

$$Y = 8 \times 10^{10} \text{Nm}^{-2} \text{ and } \rho = 2.65 \times 10^3 \text{kgm}^{-3}$$

(a) 5.5 MHz

(b) 55 MHz

(c) 0.55 MHz

(d) 5.5 kHz

**Solution**

$$(c) v = \sqrt{\frac{Y}{\rho}} = \sqrt{\frac{8 \times 10^{10}}{2.69 \times 10^3}}$$
$$= 5.5 \times 10^3 \text{ms}^{-1};$$

$$f = \frac{v}{\lambda} = \frac{5.5 \times 10^3}{2 \times 0.005} = 5.5 \times 10^5 \text{Hz.}$$

Question

Calculate the ratio of speed of sound wave in Neon to that in  $H_2O$  vapours at any temperature.

(a)  $\frac{9}{8}$

(b)  $\frac{3}{2\sqrt{2}}$

(c)  $\frac{3}{2}$

(d)  $\frac{8}{9}$

**Solution**

$$\begin{aligned} \text{(b) } \frac{v_{Ne}}{v_{H_2O}} &= \sqrt{\frac{\gamma_{Ne} M_{H_2O}}{M_{Ne} \gamma_{H_2O}}} \\ &= \sqrt{\frac{5/3 \times 18}{4/3 \times 20}} = \sqrt{\frac{9}{8}} = \frac{3}{2\sqrt{2}} \end{aligned}$$



### Question

Find the speed of sound in a mixture of 1 mole of He and 2 mole of O<sub>2</sub> at 27°C.

- (a) 480 ms<sup>-1</sup>                      (b) 621 ms<sup>-1</sup>  
(c) 401 ms<sup>-1</sup>                      (d) 601 ms<sup>-1</sup>

[IIT 1995]

**Solution** (c)  $M_{\text{mix}} = \frac{n_1 M_1 + n_2 M_2}{n_1 + n_2}$

$$= \frac{1 \times 4 + 2 \times 32}{1 + 2} = \frac{68}{3}$$

$$C_{V(\text{mixture})} = \frac{n_1 C_{V1} + n_2 C_{V2}}{n_1 + n_2} = \frac{\left(1 \times \frac{3}{2} + 2 \times \frac{5}{2}\right) R}{1 + 2}$$

$$= \frac{13}{6} R$$

$$C_{P(\text{mix})} = C_V + R = \frac{19}{6} R \text{ or } \frac{C_P}{C_V} = \frac{19}{13} R$$

$$v = \sqrt{\frac{19}{13} \times \frac{8.31 \times 300}{\frac{68}{3} \times 10^{-3}}} = 400.9 \text{ ms}^{-1}$$



Question

Two radio stations broadcast their programmes at the same amplitude  $A$  and at slightly different frequencies  $\omega_1$  and  $\omega_2$  respectively where  $\omega_2 - \omega_1 = 1$  kHz. A detector receives the signals from the two stations simultaneously. It can only detect signals of intensity  $> 2A^2$ . Find the interval between successive maxima of the intensity of the signal received by the detector.

- (a)  $2 \times 10^{-3}$ s                      (b)  $4 \times 10^{-3}$ s  
(c)  $1.5 \times 10^{-3}$ s                      (d)  $10^{-3}$ s

**Solution** (d)  $y_1 = A \sin 2\pi\omega_1 t$  and  $y_2 = A \sin 2\pi\omega_2 t$

$$y = y_1 + y_2 = A \sin 2\pi\omega_1 t + A \sin 2\pi\omega_2 t$$

$$= 2A \sin 2\pi \frac{(\omega_2 + \omega_1)}{2} t \cos 2\pi \frac{(\omega_2 - \omega_1)}{2} t$$

$$A' = 2A \cos 2\pi \frac{(\omega_2 - \omega_1)}{2} t$$

$$= 2A \cos \pi(\omega_2 - \omega_1)t$$

$$I \propto A'^2 = 4A^2 \cos^2 \pi(\omega_2 - \omega_1)t$$

For  $I$  to be maximum  $\cos \pi(\omega_2 - \omega_1)t = \pm 1$

or  $\pi(\omega_2 - \omega_1)t = 0, \pi, 2\pi, \dots$

$$T = t_2 - t_1 = \frac{1}{\omega_2 - \omega_1}$$

$$= 10^{-3}\text{s.}$$

Question

Which of the following will pair up to produce stationary wave?

(a)  $Z_1 = A \cos(kx - \omega t)$       (b)  $Z_2 = A \cos(kx + \omega t)$

(c)  $Z_3 = A \cos(kx - \omega t)$       (d)  $Z_4 = A \cos(kx + \omega t)$

(a) 1 and 2      (b) 2 and 3

(c) 3 and 4      (d) 1 and 3

[IIT 1993]

**Solution** (a) The waves must be travelling in opposite directions and have same amplitude and same frequency.

Question

A quartz crystal is used to produce ultrasonic. The frequency will be inversely related to

(a) Young's modulus.      (b) thickness.

(c) density.      (d) length.

**Solution** (b)  $f \propto 1/t$ .

### Question

Two successive resonance frequencies in an open organ pipe are 1944 and 2592 Hz. Find the length of the tube. The speed of sound in air is  $324 \text{ ms}^{-1}$

- (a) 25 cm (b) 50 cm  
(c) 12.5 cm (d) none of these

**Solution** (d)  $f_0 = 2592 - 1944 = 648 \text{ Hz}$

$$\lambda = \frac{v}{f} = \frac{324}{648} = \frac{1}{2} \text{ m}$$

or  $l = \frac{\lambda}{2} = 25 \text{ cm.}$

### Question

A cylindrical metal tube has a length of 50 cm and is open at both ends. Find the frequencies between 1 kHz to 2 kHz at which the air column in the tube resonates. The temperature on that day is  $20^\circ \text{C}$ .

- (a) 1020, 11360, 1700 Hz (b) 1026, 1368, 1710 Hz  
(c) 1328, 1660, 1922 Hz (d) none of these

**Solution** (b)  $v(T) = 330 \sqrt{1 + \frac{20}{273}}$

$$= 330 \sqrt{\frac{293}{273}} = 342 \text{ ms}^{-1}$$

$$f = \frac{v}{\lambda} = \frac{342}{1} = 342 \text{ Hz.}$$

wavelengths allowed between 1000 Hz and 2000 Hz are 1026 Hz, 1368 Hz, 1710 Hz.

Question

A tuning fork produces 4 beats per second with another tuning fork of frequency 256 Hz. The first one is now loaded with a little wax and number of beats heard are 6 per second. The original frequency of the tuning fork is

(a) 252 Hz

(b) 260 Hz

(c) 250 Hz

(d) 262 Hz

**Solution** (a)  $f = 256 \pm 4$  Hz.

On loading the first one the number of beats increase. Therefore, the frequency of the tuning fork must be 252 Hz. As it will decrease further on loading and number of beats/s increase.

Question

Two stereo speakers are separated by a distance of 2.4 m. A person stands at a distance of 3.2 m as shown directly in front of one of the speakers. Find the frequencies in audible range for which the listener will hear a minimum sound intensity.

Speed of the sound in air is  $320 \text{ ms}^{-1}$ .

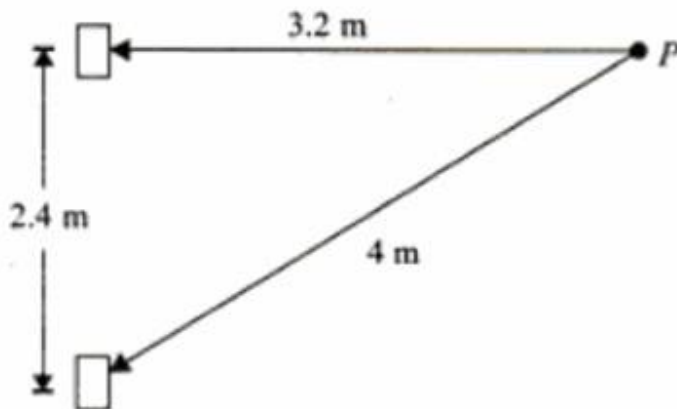

(a)  $160(2n + 1)$

(b)  $320(2n + 1)$

(c)  $200(2n + 1)$

(d)  $100(2n + 1)$

**Solution** (c)  $\sqrt{3.2^2 + 2.4^2} = 4 \text{ m}$

$$\text{Path difference} = 0.8 \text{ m} = (2n + 1) \frac{\lambda}{2}$$

$$\lambda = \frac{1.6}{(2n + 1)} \text{ using } f = \frac{v}{\lambda} = \frac{320}{1.6} (2n + 1)$$

$$= 200(2n + 1) \text{ Hz.}$$

$$n = 1, 2, 3, \dots 49 \text{ are allowed.}$$

Question

A bullet passes past a person at a speed  $220 \text{ ms}^{-1}$ . Find the fractional change in the frequency of the whistling sound heard by the person as the bullet crosses the person. Speed of sound =  $330 \text{ ms}^{-1}$ .

(a) 0.67

(b) 0.8

(c) 1.2

(d) 3.0

**Solution** (b) Limiting cases when it is just at the verge of crossing and when it has just crossed are taken.

$$f_1 = \frac{v}{v + v_s} f = 0.6f \text{ and}$$

$$f_2 = \frac{v}{v - v_s} f = 3f$$

$$f_{\text{net}} = \frac{f_1 + f_2}{2} = \frac{3.6f}{2} = 1.8f$$

$$\Delta f = 0.8f \text{ or } \frac{\Delta f}{f} = 0.8.$$

Question



Horseshoe bats (genus *Rhinolophus*) emit sounds from their nostrils, then listen to the frequency of the sound reflected from their prey to determine the prey's speed. The horse shoe that gives the bat its name is a depression around the nostrils that acts like a focussing mirror so that the bat emits sound in a narrow beam like a flash light. A *Rhinolophus* is flying at a speed  $v_{bat}$  and emits sound of frequency  $f_{bat}$ ; the sound it hears reflected from an insect flying toward it has higher frequency  $f_{ref}$ . Speed of sound is  $v_s$ .

1. Find the speed of the insect  $v_{insect} =$

$$(a) \quad v_s \left[ \frac{f_{ref} (v_s - v_{bat}) - f_{bat} (v_s + v_{bat})}{f_{ref} (v_s - v_{bat}) + f_{bat} (v_s + v_{bat})} \right]$$

$$(b) \quad v_s \left[ \frac{f_{ref} (v_s + v_{bat}) - f_{bat} (v_s - v_{bat})}{f_{ref} (v_s + v_{bat}) + f_{bat} (v_s - v_{bat})} \right]$$

$$(c) \quad v_s \left[ \frac{f_{bat} (v_s + v_{bat}) - f_{ref} (v_s - v_{bat})}{f_{ref} (v_s - v_{bat}) + f_{bat} (v_s + v_{bat})} \right]$$

$$(d) \quad v_s \left[ \frac{f_{ref} (v_s + v_{bat}) + f_{bat} (v_s - v_{bat})}{f_{ref} (v_s - v_{bat}) - f_{bat} (v_s + v_{bat})} \right]$$

2. If  $f_{\text{bat}} = 80.7 \text{ kHz}$ ,  $f_{\text{ref}} = 83.5 \text{ kHz}$  and  $v_{\text{insect}} = 2 \text{ ms}^{-1}$ . Find

$v_{\text{bat}}$

(a)  $4.9 \text{ ms}^{-1}$

(b)  $3.9 \text{ ms}^{-1}$

(c)  $5.9 \text{ ms}^{-1}$

(d)  $4.1 \text{ ms}^{-1}$

**Solution** 1. (a)  $f_1 = f_{\text{bat}} \frac{v_s + v_{\text{in}}}{v_s - v_{\text{bat}}}$

and  $f_{\text{ref}} = f_1 \frac{v_s + v_{\text{bat}}}{v_s - v_{\text{in}}}$

$$\frac{f_{\text{ref}}}{f_{\text{bat}}} = \frac{(v_s + v_{\text{in}})(v_s + v_{\text{bat}})}{(v_s - v_{\text{in}})(v_s - v_{\text{bat}})}$$

or  $\frac{f_{\text{ref}}}{f_{\text{bat}}} v_s (v_s - v_{\text{in}}) (v_s - v_{\text{bat}})$

$$= v_s^2 + v_{\text{in}} (v_s + v_{\text{bat}}) + v_s v_{\text{bat}}$$

$$\frac{f_{\text{ref}}}{f_{\text{bat}}} [v_s^2 - v_{\text{in}} (v_s - v_{\text{bat}}) - v_s v_{\text{bat}}]$$

$$= v_{\text{in}} (v_s + v_{\text{bat}}) + v_s^2 + v_s v_{\text{bat}}$$

$$\begin{aligned}v_{in} & \left[ (v_s + v_{bar}) + \frac{f_{ref}}{f_{bar}} (v_s - v_{bar}) \right] \\ & = \frac{f_{ref}}{f_{bar}} v_s (v_s - v_{bar}) - v_s (v_s + v_{bar}) \\ v_{in} & = v_s \left[ \frac{\frac{f_{ref}}{f_{bar}} (v_s - v_{bar}) - (v_s + v_{bar})}{(v_s + v_{bar}) + \frac{f_{ref}}{f_{bar}} (v_s - v_{bar})} \right] \\ & = v_s \left[ \frac{f_{ref} (v_s - v_{bar}) - (v_s + v_{bar}) f_{bar}}{f_{bar} (v_s + v_{bar}) + f_{ref} (v_s - v_{bar})} \right]\end{aligned}$$

**Solution** . 2. (b)

$$2 = \left[ \frac{83.5(340 - v_{bar}) - (340 + v_{bar})80.7}{80.7(340 + v_{bar}) + 83.5(340 - v_{bar})} \right]$$

solving for  $v_{bar}$  we get  $v_{bar} = 3.9 \text{ ms}^{-1}$

## Question

When a sound wave enters the ear it sets the ear drum into oscillation, which in turn causes oscillation of the three tiny bones in the middle ear called the ossicles. This oscillation is finally transmitted to the fluid-filled inner ear. The motion of the fluid disturbs hair cells within the inner ear, which transmit nerve impulses to the brain with the information that a sound is present. The moving part of the eardrum has an area of about  $43 \text{ mm}^2$ , and the area of the stirrup (The smallest of the ossicles) where it connects to the inner ear is about  $3.2 \text{ mm}^2$ . A moderate loudness sound of maximum pressure variation are of the order of  $3 \times 10^{-2} \text{ Pa}$  above and below atmospheric pressure of  $10^5 \text{ Pa}$ .

- Find the maximum displacement in the fluid of inner ear if frequency of the wave is 1 kHz.  $v_{\text{fluid}} = 1500 \text{ ms}^{-1}$ 
  - $4.4 \times 10^{-11} \text{ m}$
  - $4.4 \times 10^{-10} \text{ cm}$
  - $4.4 \text{ A}^0$
  - $4.4 \text{ pm}$
- Find the pressure amplitude consider mass of the ossicles = 58 mg and Bulk modulus of fluid =  $(45.8 \times 10^{-11})^{-1}$ 
  - 0.3 Pa
  - 0.4 Pa
  - 0.22 Pa
  - 0.8 Pa

**Solution** 1. (a)  $R_{\text{inner ear}} = \frac{\omega}{v} = \frac{1000 \times 2\pi}{1500} = \frac{4\pi}{3}$

$$y_0 = \frac{P_{\text{max}}(\text{inner})}{B_{\text{fluid}} R_{\text{inner ear}}}$$

$$= \frac{0.4 \times 45 \times 10^{-11}}{\frac{4\pi}{3}} = 4.4 \times 10^{-11} \text{ m}$$

**Solution** 2. (b)  $P_{\text{max}} = \frac{F_{\text{max}}}{\text{area of stirrup}}$

$$= \frac{3 \times 10^{-2} \times 43}{3.2} = 0.4 \text{ Pa}$$

Bremsstrahlung Effect

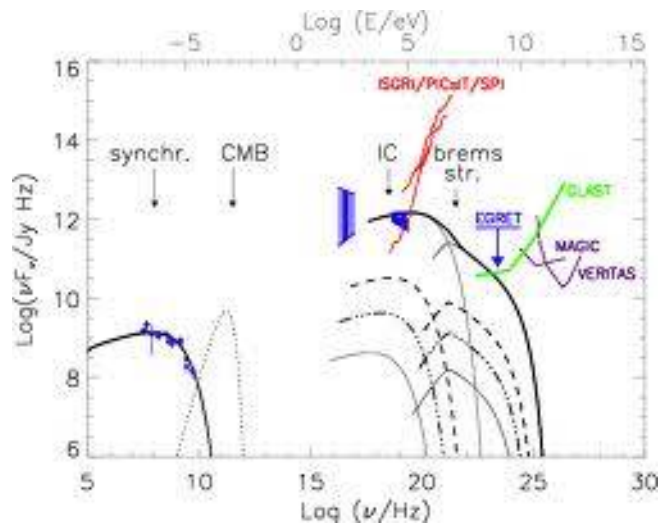
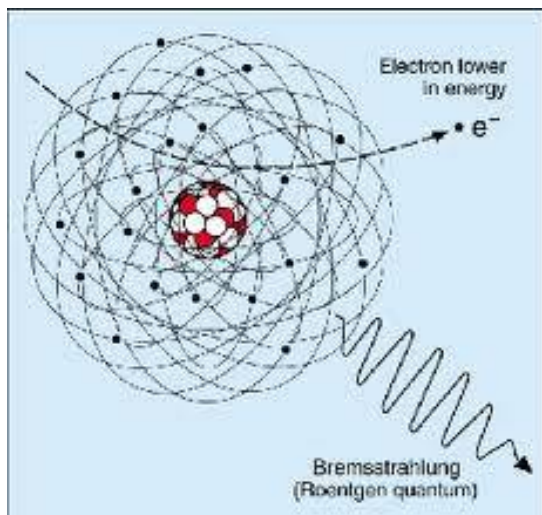
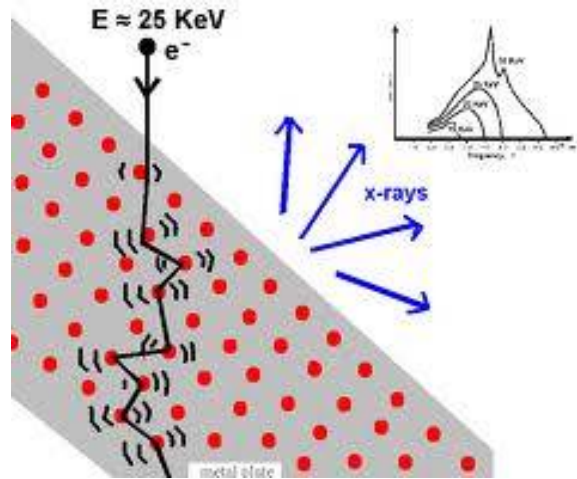
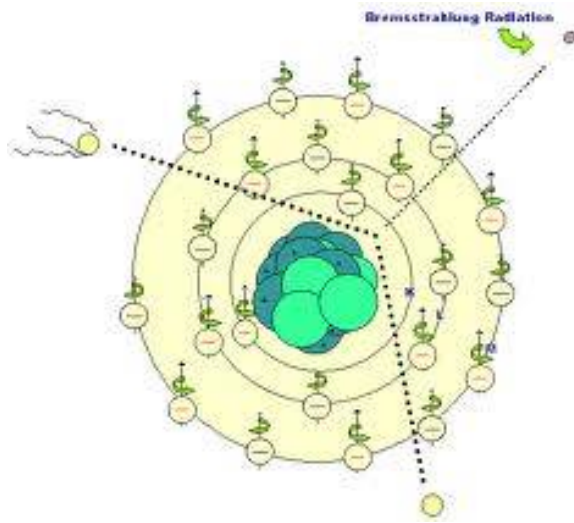

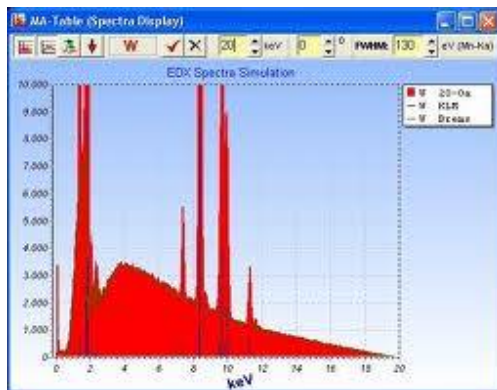
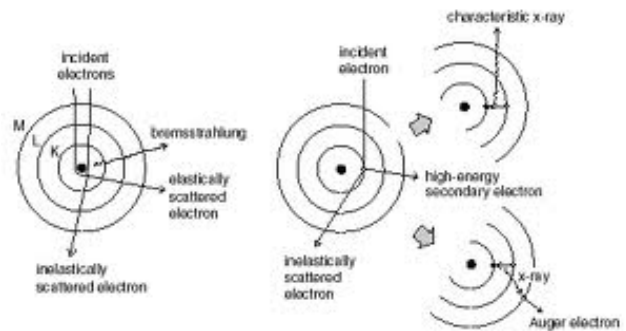
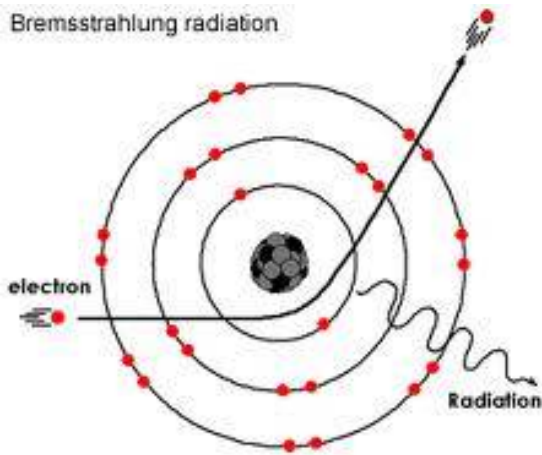
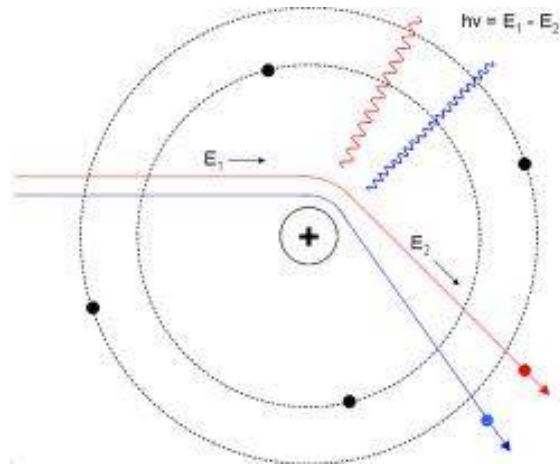
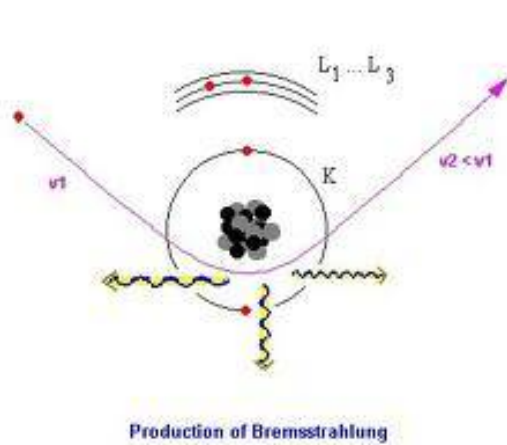

### Penetrating Distances

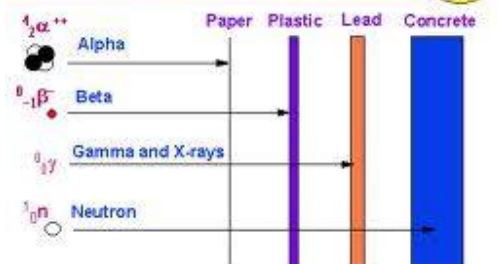

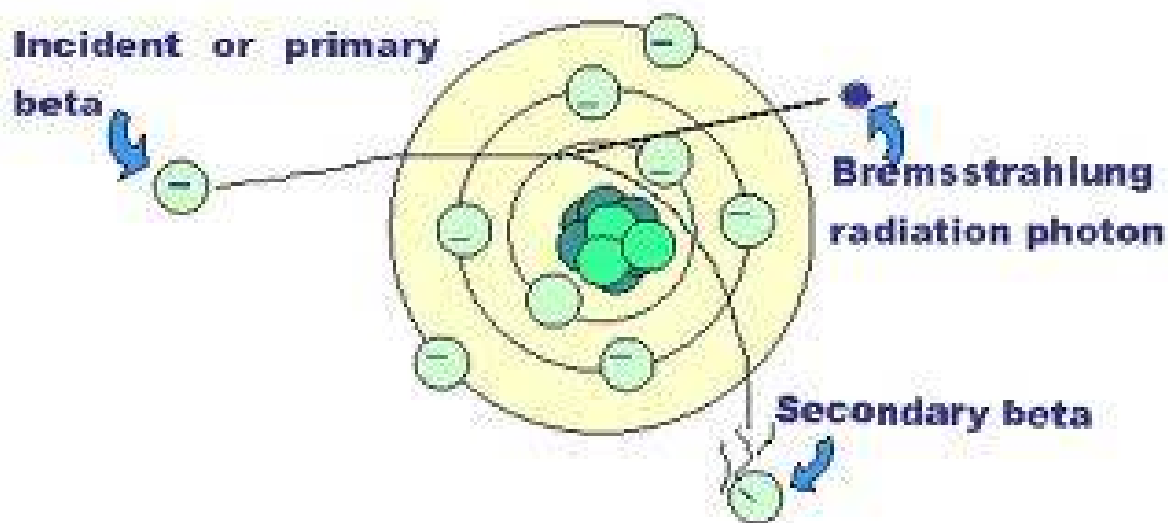

Bremsstrahlung ( German word ) from bremsen "to brake" and Strahlung "radiation", i.e. "braking radiation" or "deceleration radiation") is electromagnetic radiation produced by the deceleration of a charged particle when deflected by another charged particle, typically an electron by an atomic nucleus. The moving particle loses kinetic energy, which is converted into a photon because energy is conserved. The term is also used to refer to the process of producing the radiation. **Bremsstrahlung has a continuous spectrum**, which becomes more intense and shifts toward higher frequencies as the change of the energy of the accelerated particles increases.

Strictly speaking, bremsstrahlung is any radiation due to the acceleration of a charged particle, which includes **synchrotron radiation, cyclotron radiation, and the emission of electrons and positrons during beta decay**. However, the term is frequently used in the more narrow sense of radiation from electrons (from whatever source) stopping in matter.

Bremsstrahlung emitted from plasma is sometimes referred to as free-free radiation. This refers to the fact that the radiation in this case is created by charged particles that are free both before and after the deflection (acceleration) that causes the emission.

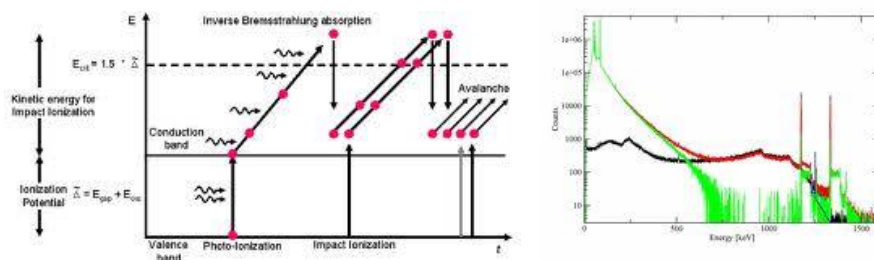



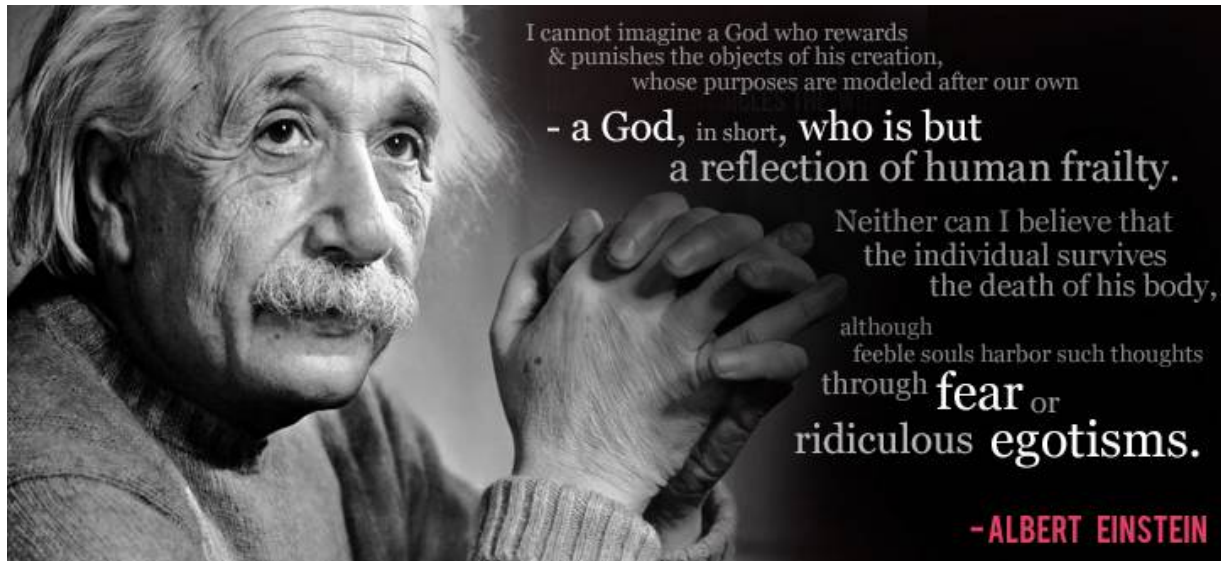

( Apart from Millions of smart people ) Several Nobel Laureates were Atheists.

Some famous examples have been [Albert Einstein](#) ( 1921 ), [Richard Feynman](#) ( 1965 ), [Erwin Schrödinger](#) ( 1933 ), [Paul Dirac](#) ( 1933 ), [Lawrence M. Krauss](#) ( 2011 ), [Niels Bohr](#) ( 1922 ), [Peter Higgs](#) ( 2013 ), [John Bardeen](#) ( **The only person receiving the Physics Nobel prize twice. 1956, 1972** ), [Frederick Sanger](#) ( **The only person receiving the Chemistry prize twice. 1958, 1980** ), [Marie Curie](#) ( 1903, 1911 ), [Frédéric Joliot-Curie](#) and [Irène Joliot-Curie](#) ( 1935 ), [Milton Friedman](#) ( 1976 ), [John Harsanyi](#) ( 1994 ), [Friedrich Hayek](#) ( 1974 ), [John Forbes Nash, Jr.](#) ( 1994 ), [Amartya Sen](#) ( 1998 ), [Subrahmanyan Chandrasekhar](#) ( 1983 ), [Enrico Fermi](#) ( 1938 ), [C. V. Raman](#) ( 1930 ), [Eugene Wigner](#) ( 1963 ), [Steven Weinberg](#) ( 1979 ), [Chen-Ning Yang](#) ( 1957 ) etc

A bigger ( incomplete ) list can be seen at

[https://en.wikipedia.org/wiki/List\\_of\\_nonreligious\\_Nobel\\_laureates](https://en.wikipedia.org/wiki/List_of_nonreligious_Nobel_laureates)

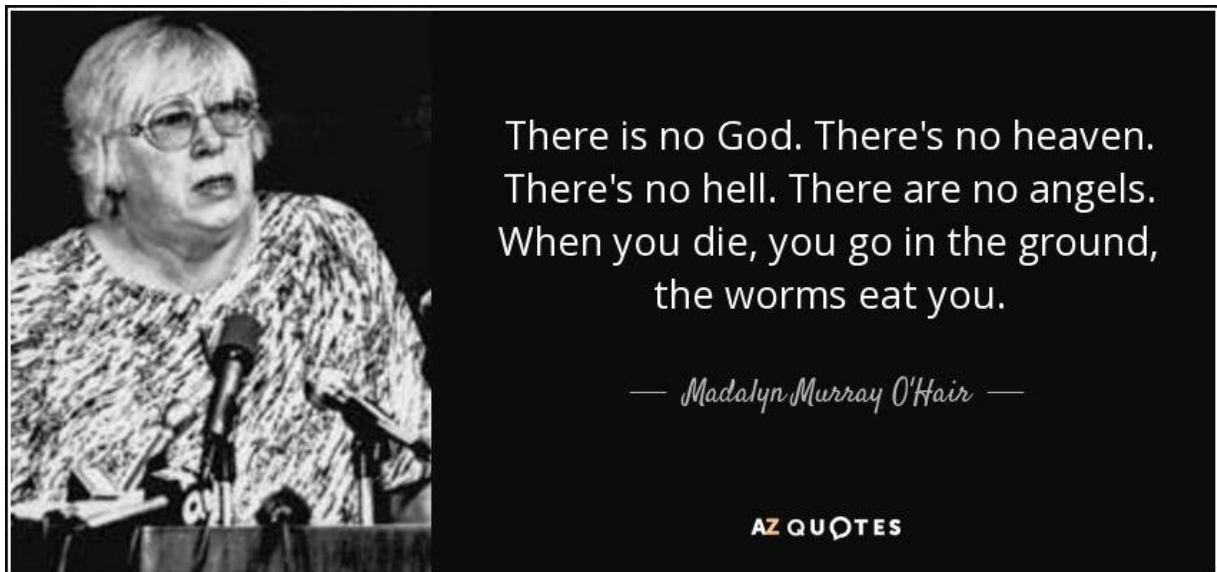

( When the body is burnt, oxides are the ash. The gases and water vapor spread in the air )

My **personal favorites** ( among these Atheists ) are **Richard Feynman**, **Peter Higgs**, **Lawrence Krauss**.

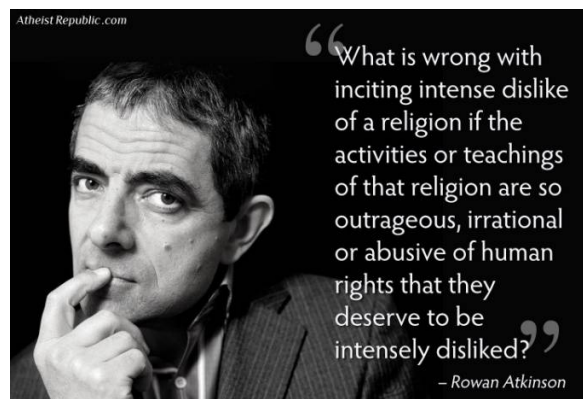
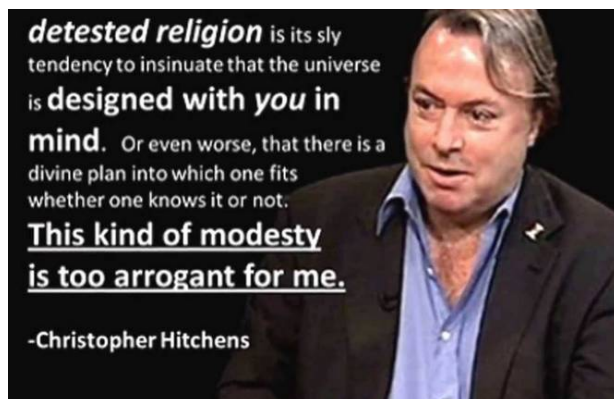

Richard Feynman openly laughed ( Publicly and in class ) about Gods, Fairies etc. see <https://www.youtube.com/watch?v=j3mhkYbznBk>

and [https://www.youtube.com/results?search\\_query=Richard+Feynman](https://www.youtube.com/results?search_query=Richard+Feynman)

Approx 200 years ago; around 1800, Pierre-Simon Laplace developed a **new branch of Mathematics**, **Perturbation theory**. Perturbation theory was investigated by the classical scholars — Laplace, Poisson, Gauss — as a result of which the computations could be performed with a **very high accuracy**. The discovery of the planet Neptune in 1848 by Urbain Le Verrier, based on the deviations in motion of the planet Uranus (he sent the coordinates to Johann Gottfried Galle who successfully observed Neptune through his telescope), represented a triumph of perturbation theory.

Gravitation by Prof. Subhashish Chattopadhyay SKMClasses Bangalore Useful for IIT-JEE, CBSE, I.Sc. PU-II, Boards, CET, CEE, PET, IGCSE IB AP-Physics and other exams

Laplace was **one the first persons** who did **not** see or use "hand of God" ( or role of God ) to explain something. Newton's Gravitation equations for Two masses, were not enough to explain stability of multibody, rather multi planet and Sun system. **Perturbation Theory could accommodate cumulative effects of many small forces.**

While talking to Napoleon,( discussing the theory ); Laplace said, ( about God ) "**that**" ( God ) hypothesis is **not** needed.

<http://www.naturalhistorymag.com/universe/211420/the-perimeter-of-ignorance>

[https://en.wikipedia.org/wiki/Perturbation\\_theory](https://en.wikipedia.org/wiki/Perturbation_theory)

[https://en.wikipedia.org/wiki/Pierre-Simon\\_Laplace](https://en.wikipedia.org/wiki/Pierre-Simon_Laplace)

Peter Higgs was very unhappy about " Higgs Boson " being called "G..( I don't want to name this ) Particle". **Stupid Journalists**, Media, and dumb people kept repeating that word, and **Peter requested to refrain from using this word**. Now for Madala Boson also the **Stupid Journalists**, Media, and dumb people are using that same G word.

**Lawrence Krauss openly laughs and ridicules the Theists or any non-Atheists. The crap of Agnosticism does not work with me or Krauss.**

**Empty Space is not empty. Mass of Proton, Neutron is not sum of masses of Quarks**

<https://archive.org/details/EmptySpacesNotEmptyMassOfProtonNeutronIsNotSumOfMassesOfQuarks>

We are in Modern Times. I am lucky to learn the correct things quite early in my life, in a so " peaceful " society. When I was in standard 9, ( in early 1980s ), I was writing a book on Atheism. I was convinced to understand, learn, and imbibe the correct approach and knowledge.

But that was not the case previously. Copernicus used to discuss and explain people widely and randomly, that Earth is rotating around the Sun, and it is not a Geocentric" universe. Nicolaus Copernicus had to waste lot of time arguing, fighting and convincing the stupids.

Measuring something, which is very slow; is very difficult. I have asked lot of "educated / engineer / Software or IT ( senior position ) Parents" that " How do we know that Earth is moving around the Sun in 365 days or say 365.242196 days " ? **Believe me I never got an answer**. The Modern iPad / smartphone **community in general does not know how 365.24 days was measured almost thousand years ago !**

A metal triangle was set at top of buildings ( Mosques or churches ) and the position of the shadow was marked at a particular time. Say 8 AM each day. The position of the shadow varied each day. It was seen that after 365 days the shadow matched the position but after sometime, not exactly at 8 AM but after a few hours ( approx 6 hours ) so at around 2 PM or slightly before.

Gravitation by Prof. Subhashish Chattopadhyay SKMClasses Bangalore Useful for IIT-JEE, CBSE, I.Sc. PU-II, Boards, CET, CEE, PET, IGCSE IB AP-Physics and other exams

Gravitation by Prof. Subhashish Chattopadhyay SKMClasses Bangalore Useful for IIT-JEE, CBSE, I.Sc. PU-II, Boards, CET, CEE, PET, IGCSE IB AP-Physics and other exams

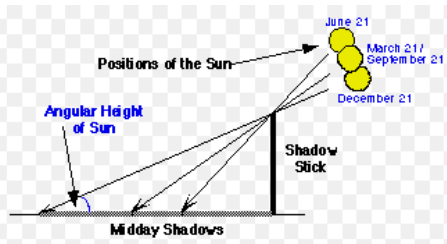
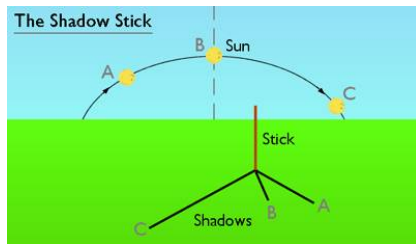

See details of this at <http://blog.world-mysteries.com/science/ancient-timekeepers-part-2-observing-the-sky/>

<http://blog.world-mysteries.com/science/ancient-timekeepers-part4-calendars/>

See the video [https://www.youtube.com/watch?v=lhqzW97\\_47w](https://www.youtube.com/watch?v=lhqzW97_47w)

<https://thecuriousastronomer.wordpress.com/2012/10/>

Much tougher questions are " How many different kind of years do we have ? "

Or " What is the difference between ' **Sidereal year** ' and ' **Tropical year** ' "

Meteors were coming from sky. These were called ' shooting stars '. Meteors often had Iron in them. Sidero is a combining form meaning "star," "constellation," used in the formation of compound words. Greeks used the word siderolite for Iron. Next the source of meteors; the sky itself was named the same. As year was measured using objects from sky; Sun and shadows; the year was named a " **Sidereal Year** "

To avoid embarrassing people; I don't ask ....

See the answers in <https://www.youtube.com/watch?v=cGjP3vAZGa4>

<https://www.youtube.com/watch?v=qgsrVyW53DY>

It took many centuries to introduce the leap year corrections. A century is a leap year only if divisible by 400 and not the rule of divisible by 4. Year 1900 was not a Leap year. But year 2000 was. I have met computer Science guys who are aware that Microsoft Database SQL-server do not accept some old dates, while Oracle database does not accept some specific dates of the past. But none whom I met knew the detailed or actual reasons.

See <https://zookeepersblog.wordpress.com/everyone-must-know-about-the-calendar/>

**" How do you prove that day and night is happening due to rotation of Earth around its own axis in contrast to Sun is rotating around Earth " ?**

No student from Bangalore, whom I met, answered this. Though conservation of Angular Momentum is in course. ( I am being polite ) Hardly met any parent who knew the explanation. See [https://www.youtube.com/watch?v=iqpV1236\\_Q0](https://www.youtube.com/watch?v=iqpV1236_Q0)

And <https://www.youtube.com/results?q=Foucault%27s+pendulum>

Gravitation by Prof. Subhashish Chattopadhyay SKMClasses Bangalore Useful for IIT-JEE, CBSE, I.Sc. PU-II, Boards, CET, CEE, PET, IGCSE IB AP-Physics and other exams

Gravitation by Prof. Subhashish Chattopadhyay SKMClasses Bangalore Useful for IIT-JEE, CBSE, I.Sc. PU-II, Boards, CET, CEE, PET, IGCSE IB AP-Physics and other exams

What about Gyroscopes ?

Approx 300 year back around 1750 the gyroscopes were made.

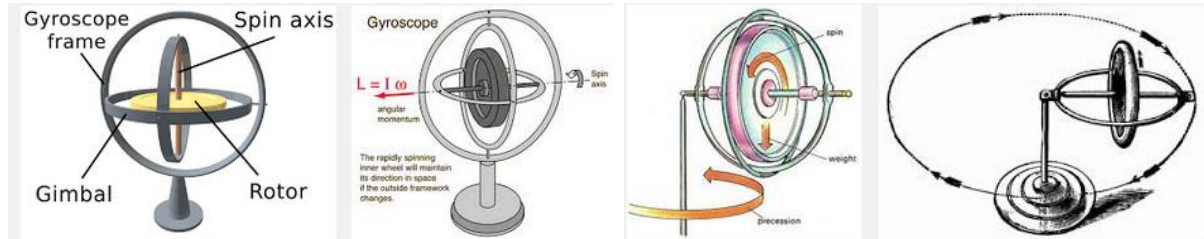

History of Gyroscope <http://www.gyroscopes.org/history.asp>

See about Gyroscopes in [https://www.youtube.com/watch?v=cquvA\\_lpEsA](https://www.youtube.com/watch?v=cquvA_lpEsA)

<https://www.youtube.com/watch?v=awXTZt86gz0>

<https://www.youtube.com/watch?v=zbdrrpXb-fY>

<https://www.youtube.com/watch?v=N92FYHHT1qM>

[https://en.wikipedia.org/wiki/Earth%27s\\_orbit](https://en.wikipedia.org/wiki/Earth%27s_orbit)

<https://www.youtube.com/watch?v=ZcWsjIGPPFQ>

Must see

<https://www.youtube.com/watch?v=SnMmBmzoVQc&list=PL68IJE2PG4AnVVMs7WvOYbJDmqf4umHG1>

Must know ...

[https://www.youtube.com/watch?v=zjV3PQ4f6IM&list=PLTve54sz-eh\\_P29Sbbv\\_j3bC97OFaArOd](https://www.youtube.com/watch?v=zjV3PQ4f6IM&list=PLTve54sz-eh_P29Sbbv_j3bC97OFaArOd)

Tyco Brahe took the boldest step to create the " Foundation of Science ". Experiments or "Double blind experimental observations" are the supreme. The **Theory follows the experimental verification.**

[ There are some universities who award M.Sc in Psychology. A psychologist may **guess** something .... **But that is not reality or truth.** Till something is experimentally verified it remains as a Perception. Truth is known only after experiments. Because the subject Psychology; completely stands of experimental verification; so the Master in Science degree. ]

Gravitation by Prof. Subhashish Chattopadhyay SKMClasses Bangalore Useful for IIT-JEE, CBSE, I.Sc. PU-II, Boards, CET, CEE, PET, IGCSE IB AP-Physics and other exams

Gravitation by Prof. Subhashish Chattopadhyay SKMClasses Bangalore Useful for IIT-JEE, CBSE, I.Sc. PU-II, Boards, CET, CEE, PET, IGCSE IB AP-Physics and other exams



Galileo Galilei  
(1564-1642)

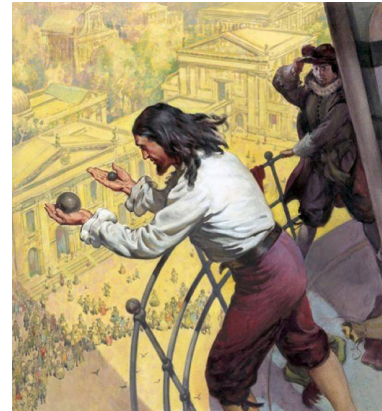
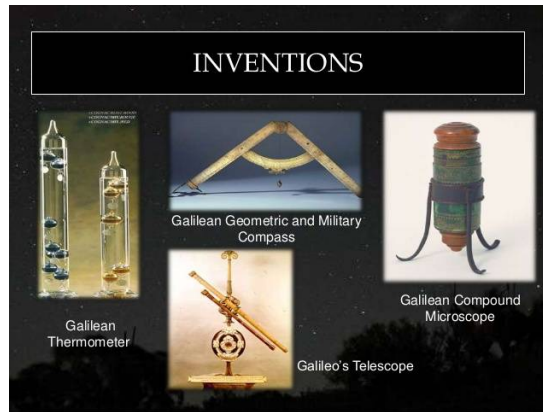

Galileo was the first person who wanted to experimentally verify the speed of light.

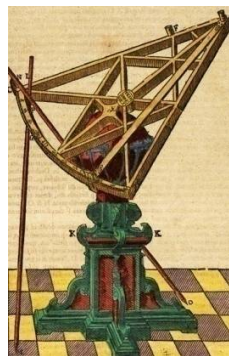

Tycho decided to observe the skies ( around 1573 ). In those days sky was synonymous to God. He had the courage to go to the King to ask for donations to make an observatory. He said to the king that "he wants to observe the Gods and take conclusions ". Salute to Tycho's paradigm that even Gods can be observed and conclusions can be drawn.

Amazing leap to start Science.

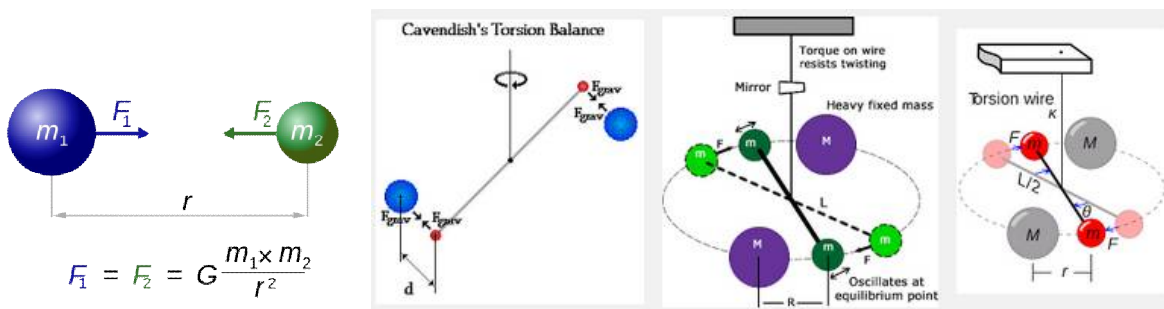

Since those days till now we observed and concluded about Kepler's Laws, Gravitation Laws, We concluded that there was no **Phlogiston** or Flogiston, Cavendish measuring value of G, measuring speed of light, X-Ray, **Electromagnetism / Maxwell's equations**, Radioactivity, No Aether was " observed " in Michelson Morley's experiments, Protons, Neutrons, General Theory of Relativity, Slowing of clocks at high speed, Bending of space, **Bending of light and**

Gravitation by Prof. Subhashish Chattopadhyay SKMClasses Bangalore Useful for IIT-JEE, CBSE, I.Sc. PU-II, Boards, CET, CEE, PET, IGCSE IB AP-Physics and other exams

Gravitation by Prof. Subhashish Chattopadhyay SKMClasses Bangalore Useful for IIT-JEE, CBSE, I.Sc. PU-II, Boards, CET, CEE, PET, IGCSE IB AP-Physics and other exams

**gravitational lens**, YDSE, Quantum Mechanics, Ernst **Ruska** designed and built the first **electron microscope**, **Casimir Forces**, Virtual particles and more than 400 kinds of particles, Quarks, Unruh effect ( an accelerating thermometer shows higher temperature ), Negative Kelvin Temperature, Bose-Einstein condensates, Superconductivity, **Solution to EPR paradox by John Stewart Bell**, Violation of Parity in certain situations - Madam Wu, Yang and Lee, Quantum entanglement in Alain Aspect's Experiments, Black holes, mass of Neutrinos, Caesium Atomic Clocks, Dark Matter, Dark energy, Magnetic Monopole, Gravitational Waves, Nano Materials, Meta Materials, Quantum Computers .....

**No God was observed**, or **no role of God was observed**. There is no conspiracy theory going around in Science. Those who want to verify God have to die waiting

... Nothing ever will be reported regarding this illusion.

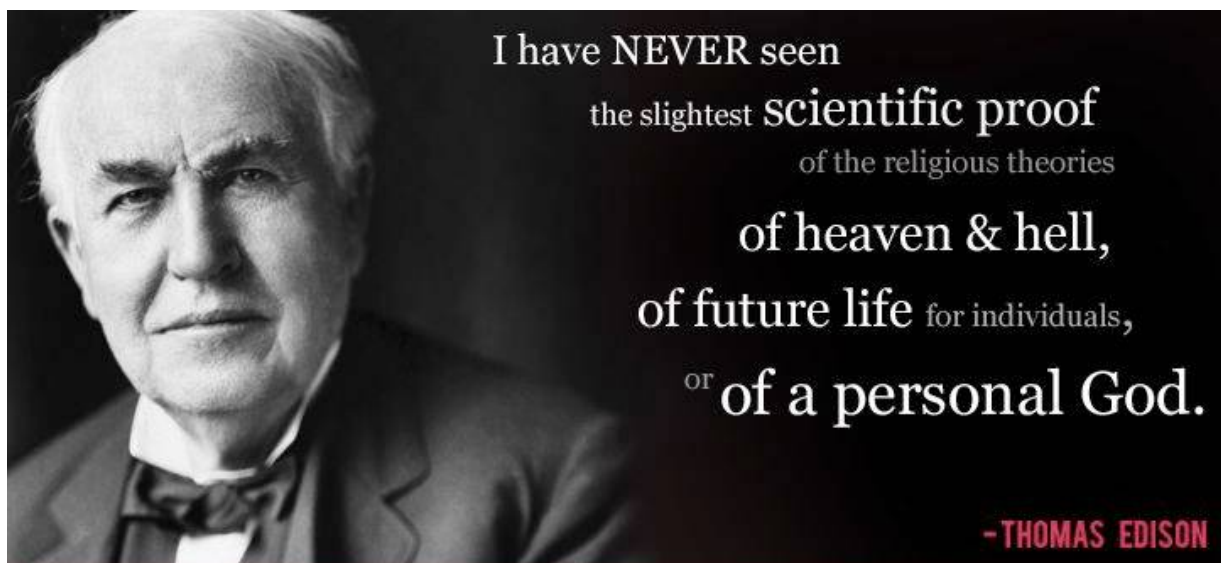

[ **Stupids had proposed the phlogiston theory**. This was a superseded scientific theory that postulated that a fire-like element called phlogiston is contained within combustible bodies and released during combustion. The name comes from the Ancient Greek φλογιστόν phlogistón (burning up), from φλόξ phlóx (flame).]

In contrast see <http://www.americanscientist.org/issues/pub/burn-magnet-burn>

**Some examples of stupidity to show / explain by contrasts; will be the right approach.**

Gravitation by Prof. Subhashish Chattopadhyay SKMClasses Bangalore Useful for IIT-JEE, CBSE, I.Sc. PU-II, Boards, CET, CEE, PET, IGCSE IB AP-Physics and other exams

## Aristotle used goat urine and Hippocrates recommended pigeon droppings. For what?



As a treatment for baldness. Men have never found baldness an appealing trait, in spite of stories that bald men are sexier. (Stories usually spread by bald men.) Virtually anything that can be done to a bald pate has been tried to stimulate hair growth. The ancient Egyptians were fond of rancid crocodile or hippo fat. If it smelled bad, surely it must do some good. It didn't. Cleopatra experimented with a goo made of ground horse teeth and deer marrow to spur Julius Caesar's dormant hair follicles into action. When this didn't work she traded him in for Mark Antony. During the Victorian era cold tea was brushed on the scalp, followed by citrus juice. In farming areas chickens were persuaded to leave deposits on a bald head and cows to lick it. Electric combs, suction caps and paint thinner have been tried. At a secluded farmhouse in Pennsylvania, Marcella Ferens rakes a glass instrument filled with a purple gas across the head to "sterilize the scalp." Then the subject holds a wire attached to some electrical machine while the operator holds a second wire as she massages the bald area with a secret formula. This forces the formula into the scalp. Some infomercials push shampoos with special emulsifiers to clean follicles as if baldness were due to plugged follicles. Others use jumbled language to promote spray paint to cover bald spots. The truth is that only Rogaine (minoxidil) rubbed on the scalp or Propecia (finasteride) taken orally have shown any effect in growing hair. Even with these the results are not impressive. The Bald Headed Men of America, headquartered appropriately in Morehead, North Carolina, was started when the founder was refused a job because he was bald. They take a different tack. If you want to waste your hormones growing hair....go ahead" Actually this is a wrong statement because it is high levels of dihydrotestosterone that can cause baldness. They are on firmer footing with their slogan. No rugs or drugs.

Aristotle used Goat Urine and Hippocrates recommended Pigeon droppings to cure baldness.

<http://dazeinfo.com/2010/06/22/superstitions-across-different-countries-an-overview/>

## **Australians bathed inside rotting whales to 'cure' rheumatism**



**The Australian National Maritime Museum has revealed that sufferers of rheumatism were once advised to sit inside the festering carcasses of whales in order to relieve their symptoms.**

The museum has recently opened a new exhibit in Sydney, which seeks to uncover the diversity, origins and adaptation of whales, charting their development from land mammals to aquatic giants. The exhibition, entitled "Amazing Whales" also looks at the different relationships humans have had with the cetaceans, which includes their apparent medicinal qualities.

Those afflicted with rheumatism were advised to sit inside the belly of a dead whale for approximately 30 hours. If the patient could stay the course and withstand this bizarre practice, they were promised at least 12 months of relief from pain.

<http://www.wired.co.uk/article/whale-bath>

### **Weird Bizarre superstitions to cure disease**

<http://www.historyextra.com/feature/animals/10-historical-superstitions-we-carry-today>

<http://listverse.com/2013/01/21/10-crazy-cures-for-the-black-death/>

### **Millions of People are making money out of superstitions of Fools**

*Rebirthing Therapy, Reiki, Energy-Deflecting Golfer Pendant, Maggot Debridement Therapy, Leech Therapy, Beer spas, Ozone Anti-Aging ..... the list is very big.*

<http://webecoist.momtastic.com/2010/07/05/12-most-bizarre-modern-alternative-medical-treatments/>

<http://oddrandomthoughts.com/strange-and-bizarre-medicine-and-cures/>

<http://www.stylist.co.uk/life/13-strange-superstitions>

So in simple words instead of taking opinions of Stupid Fools, or wasting any time arguing with them ..... Let study science correctly, without bias !

Aristotle is yet Famous, because Girls come to know about his name in school text books. Though not sure why !

Gravitation by Prof. Subhashish Chattopadhyay SKMClasses Bangalore Useful for IIT-JEE, CBSE, I.Sc. PU-II, Boards, CET, CEE, PET, IGCSE IB AP-Physics and other exams

Aristotle told at-least one statement correct !

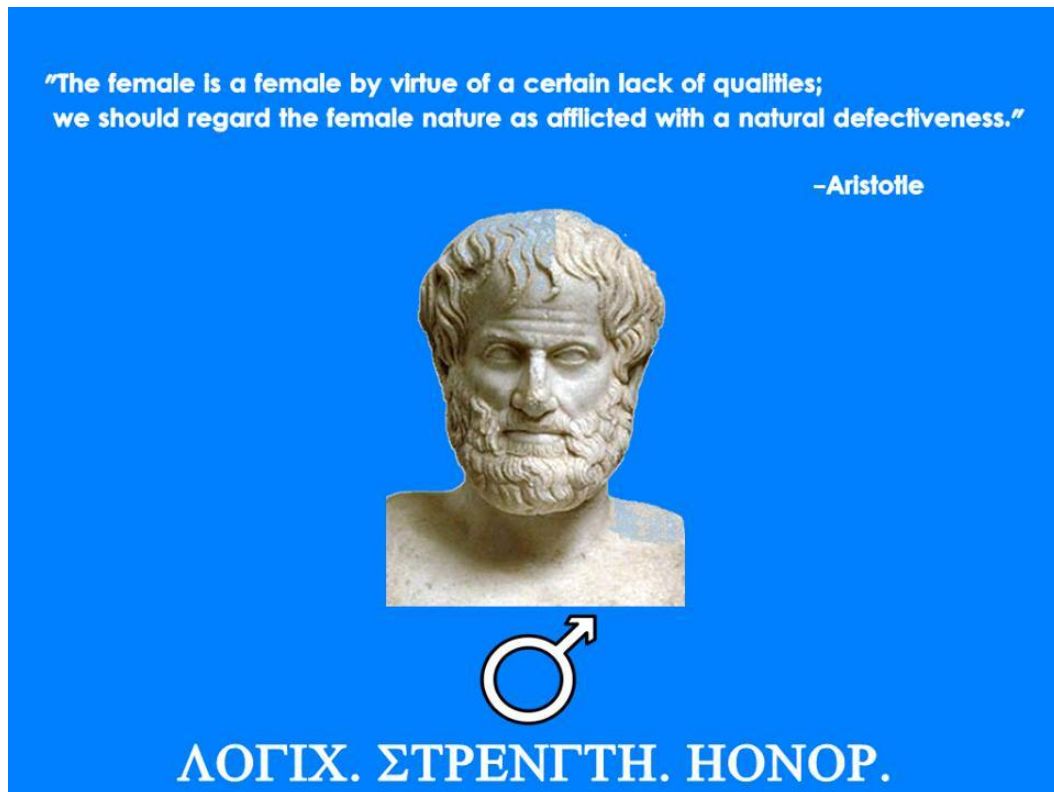

Most important physics experiments ( that a certain kind of Apes conducted ) can be seen at

See <http://www.explainthatstuff.com/great-physics-experiments.html>

<http://physics-animations.com/Physics/English/top10.htm>

[https://en.wikipedia.org/wiki/List\\_of\\_experiments](https://en.wikipedia.org/wiki/List_of_experiments)

<https://www.quora.com/What-are-some-of-the-most-important-experiments-in-physics>

Gravitation by Prof. Subhashish Chattopadhyay SKMClasses Bangalore Useful for IIT-JEE, CBSE, I.Sc. PU-II, Boards, CET, CEE, PET, IGCSE IB AP-Physics and other exams

Gravitation by Prof. Subhashish Chattopadhyay SKMClasses Bangalore Useful for IIT-JEE, CBSE, I.Sc. PU-II, Boards, CET, CEE, PET, IGCSE IB AP-Physics and other exams

### Though my list will be as follows -

Michelson-Morley experiment proving there was no Aether, Measurement of  $e/m$  then  $e$  (charge of electron) and  $m$  (mass of electron), Fizeau's method of measuring the speed of light, Moseley's experiment with X-Rays to discover Protons, Jagadish chandra Bose demonstrating controlled emission / transmission and receiving of Radio waves, Casimir experiments to show Casimir forces of virtual particles, Edington measuring bending of light, Flying atomic clocks in planes and confirming slowing down of time at high speeds, Victor Hess measured Radiation level variation at ground and high up in the atmosphere, Soviet physicist Sergey Vernov was the first to use radiosondes to perform cosmic ray readings with an instrument carried to high altitude by a balloon at heights up to 13.6 km, The proof of time dilation by Muon decay <https://debunkingrelativity.com/muons-time-dilation/>, Measurement of Space-time curvature near Earth and thereby the stress-energy tensor (which is related to the distribution and the motion of matter in space) in and near Earth [https://en.wikipedia.org/wiki/Gravity\\_Probe\\_B](https://en.wikipedia.org/wiki/Gravity_Probe_B), Detecting Gravitational Waves.

[ In 1909 Theodor Wulf developed an electrometer, a device to measure the rate of ion production inside a hermetically sealed container, and used it to show higher levels of radiation at the top of the Eiffel Tower than at its base. However, his paper published in *Physikalische Zeitschrift* was not widely accepted. In 1911 Domenico Pacini observed simultaneous variations of the rate of ionization over a lake, over the sea, and at a depth of 3 meters from the surface. Pacini concluded from the decrease of radioactivity underwater that a certain part of the ionization must be due to sources other than the radioactivity of the Earth. In 1912, Victor Hess carried three enhanced-accuracy Wulf electrometers to an altitude of 5300 meters in a free balloon flight. He found the ionization rate increased approximately fourfold over the rate at ground level. Hess ruled out the Sun as the radiation's source by making a balloon ascent during a near-total eclipse. With the moon blocking much of the Sun's visible radiation, Hess still measured rising radiation at rising altitudes. He concluded "The results of my observation are best explained by the assumption that a radiation of very great penetrating power enters our atmosphere from above." In 1913-1914, Werner Kolhörster confirmed Victor Hess' earlier results by measuring the increased ionization rate at an altitude of 9 km. Hess received the Nobel Prize in Physics in 1936 for his discovery. Homi J. Bhabha derived an expression for the probability of scattering positrons by electrons, a process now known as Bhabha scattering. His classic paper, jointly with Walter Heitler, published in 1937 described how primary cosmic rays from space interact with the upper atmosphere to produce particles observed at the ground level. Bhabha and Heitler explained the cosmic ray shower formation by the cascade production of gamma rays and positive and negative electron pairs. Soviet physicist Sergey Vernov was the first to use radiosondes to perform cosmic ray readings with an instrument carried to high altitude by a balloon. On 1 April 1935, he took measurements at heights up to 13.6 kilometers using a pair of Geiger counters in an anti-coincidence circuit to avoid counting secondary ray showers. ]

See [https://en.wikipedia.org/wiki/Cosmic\\_ray](https://en.wikipedia.org/wiki/Cosmic_ray)

<http://web.mit.edu/8.13/www/JLEperiments/JLExp14.pdf>

Gravitation by Prof. Subhashish Chattopadhyay SKMClasses Bangalore Useful for IIT-JEE, CBSE, I.Sc. PU-II, Boards, CET, CEE, PET, IGCSE IB AP-Physics and other exams

Gravitation by Prof. Subhashish Chattopadhyay SKMClasses Bangalore Useful for IIT-JEE, CBSE, I.Sc. PU-II, Boards, CET, CEE, PET, IGCSE IB AP-Physics and other exams

<http://web.mit.edu/lululiu/Public/pixx/not-pixx/muons.pdf>

[https://en.wikipedia.org/wiki/Time\\_dilation](https://en.wikipedia.org/wiki/Time_dilation)

<http://www.physics.rutgers.edu/ugrad/389/muon/muonphysics.pdf>

<http://www2.fisica.unlp.edu.ar/~veiga/experiments.html>

## Detecting Neutrons

Rutherford predicted the existence of the neutron in 1920. Twelve years later, his assistant James Chadwick found it. At Cambridge, Chadwick searched for the neutron. He tried in 1923, but did not find it. He tried again in 1928, with no success. In 1930, the German physicists Walther Bothe and Herbert Becker noticed something odd. When they shot alpha rays at beryllium (atomic number 4) the beryllium emitted a neutral radiation that could penetrate 200 millimeters of lead. In contrast, it takes less than one millimeter of lead to stop a proton. Bothe and Becker assumed the neutral radiation was high-energy gamma rays.

Marie Curie's daughter, Irene Joliot-Curie, and Irene's husband, Frederic, put a block of paraffin wax in front of the beryllium rays. They observed high-speed protons coming from the paraffin. They knew that gamma rays could eject electrons from metals. They thought the same thing was happening to the protons in the paraffin. Chadwick said the radiation could not be gamma rays. To eject protons at such a high velocity, the rays must have an energy of 50 million electron volts. An electron volt is a tiny amount of energy, only enough to keep a 75-watt light bulb burning for a tenth of a trillionth of a second. The alpha particles colliding with beryllium nuclei could produce only 14 million electron volts.

The law of conservation of energy states that energy can neither be created nor destroyed. It certainly looked as if energy was being created along with the neutral radiation. Chadwick had another explanation for the beryllium rays. He thought they were neutrons. He set up an experiment to test his hypothesis.

**Chadwick put a piece of beryllium in a vacuum chamber with some polonium.** The polonium emitted alpha rays, which struck the beryllium. When struck, the beryllium emitted the mysterious neutral rays.

Gravitation by Prof. Subhashish Chattopadhyay SKMClasses Bangalore Useful for IIT-JEE, CBSE, I.Sc. PU-II, Boards, CET, CEE, PET, IGCSE IB AP-Physics and other exams

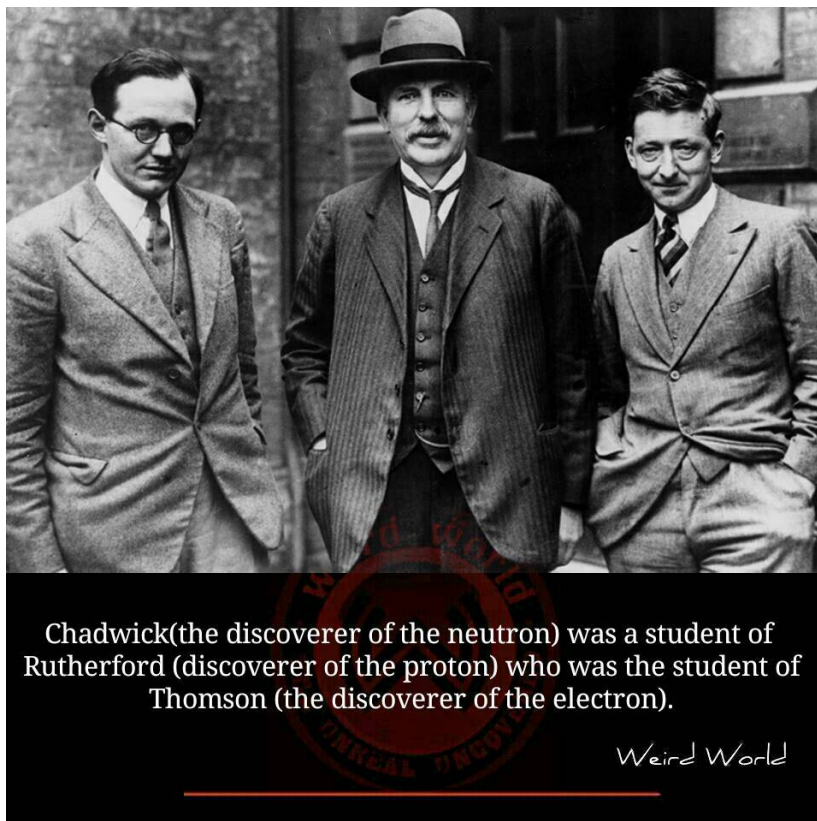

In the path of the rays, Chadwick put a target. When the rays hit the target, **they knocked atoms out of it**. The atoms, which became electrically charged in the collision, flew into a detector. Chadwick's detector was a chamber filled with gas. When a charged particle passed through the chamber, it ionized the gas molecules. The ions drifted toward an electrode. Chadwick measured the current flowing through the electrode. Knowing the current, he could count the atoms and estimate their speed. Chadwick used targets of different elements, measuring the energy needed to eject the atoms of each. Gamma rays could not explain the speed of the atoms. The only good explanation for his result was a neutral particle. **To prove that the particle was indeed the neutron, Chadwick measured its mass.** He could not weigh it directly. Instead he measured everything else in the collision and used that information to calculate the mass.

For his mass measurement, Chadwick bombarded boron with alpha particles. Like beryllium, boron emitted neutral rays. Chadwick placed a hydrogen target in the path of the rays. When the rays struck the target, protons flew out. Chadwick measured the velocity of the protons.

Using the laws of conservation of momentum and energy, Chadwick calculated the mass of the neutral particle. It was 1.0067 times the mass of the proton. The neutral radiation was indeed the long-sought neutron.

<http://ansnuclearcafe.org/2011/10/19/pioneers102011/>

Gravitation by Prof. Subhashish Chattopadhyay SKMClasses Bangalore Useful for IIT-JEE, CBSE, I.Sc. PU-II, Boards, CET, CEE, PET, IGCSE IB AP-Physics and other exams

100 Greatest Discoveries of Physics

<https://www.youtube.com/watch?v=Bpid0LBTqWg>

( As I write these words { 2016 } GUT [ General Unified Theory ] is being modified to introduce a 5th fundamental force, because some heavy particles have been observed at CERN and various other experiments and Producing Gravitational waves at will, without mass, Madala Bosons to explain Dark Matter )



Learn Science from <https://www.youtube.com/user/cassiopeiaproject/videos>

Some easy Physics ( much easier than IIT-JEE )

[https://www.youtube.com/channel/UCIiSRiiRVQuDfgxl\\_QN\\_Fmw/videos](https://www.youtube.com/channel/UCIiSRiiRVQuDfgxl_QN_Fmw/videos)

( Pradeep Kshetrapal Sir's Videos are at -

<https://www.youtube.com/user/PradeepKshetrapal/videos> )

IIT-JEE is extremely tough for most humans. A productive PhD in Physics, or actually contributing to growth of the subject is much more tougher ( than IIT JEE ). { **I personally know quite a few IIT-JEE single or double digit rankers, joining for PhD and then dropped out due to performance** }. **Most people have an illusion that they can argue with Scientists and imagine to ask some " smart " questions which the Scientists will not able to answer, so the argument is won, and existence of God is proved.** As if Scientist are eagerly sitting or waiting to answer every crap asked. I can only say; that most scientists ( since more than 100 years ) have stopped wasting their time arguing or convincing fools. I am not a Scientist. Even being a simple teacher, I do not try to teach fools, or argue with anyone.

[ **For History of Physics I recommend**

<http://www.historyworld.net/wrldhis/PlainTextHistories.asp?ParagraphID=kqg> ]

[ Gravitational lens and Einstein ring due to bending of light by mass ]

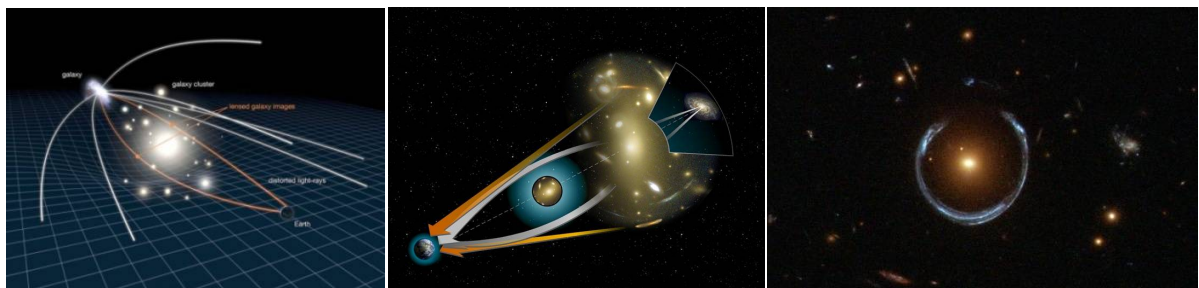

Gravitation by Prof. Subhashish Chattopadhyay SKMClasses Bangalore Useful for IIT-JEE, CBSE, I.Sc. PU-II, Boards, CET, CEE, PET, IGCSE IB AP-Physics and other exams

Gravitation by Prof. Subhashish Chattopadhyay SKMClasses Bangalore Useful for IIT-JEE, CBSE, I.Sc. PU-II, Boards, CET, CEE, PET, IGCSE IB AP-Physics and other exams

Recall what I said at the beginning of the book .... " **Someone will learn only by his hard work, his desire to learn.** " No arguments or no 'time wasting' with fools. There is too much of good material ( data, books, videos etc ) out and free in this world. If someone wants to learn, can learn; **instead of wasting time arguing.** Since centuries stupids and/or fools are being eliminated in various exams. Entrance exam, is a misnomer. These are elimination tests. The society has systems of Interviews, Peer reviews, appraisals, Thesis evaluation etc... to eliminate crap, foolish things, and nonsense.

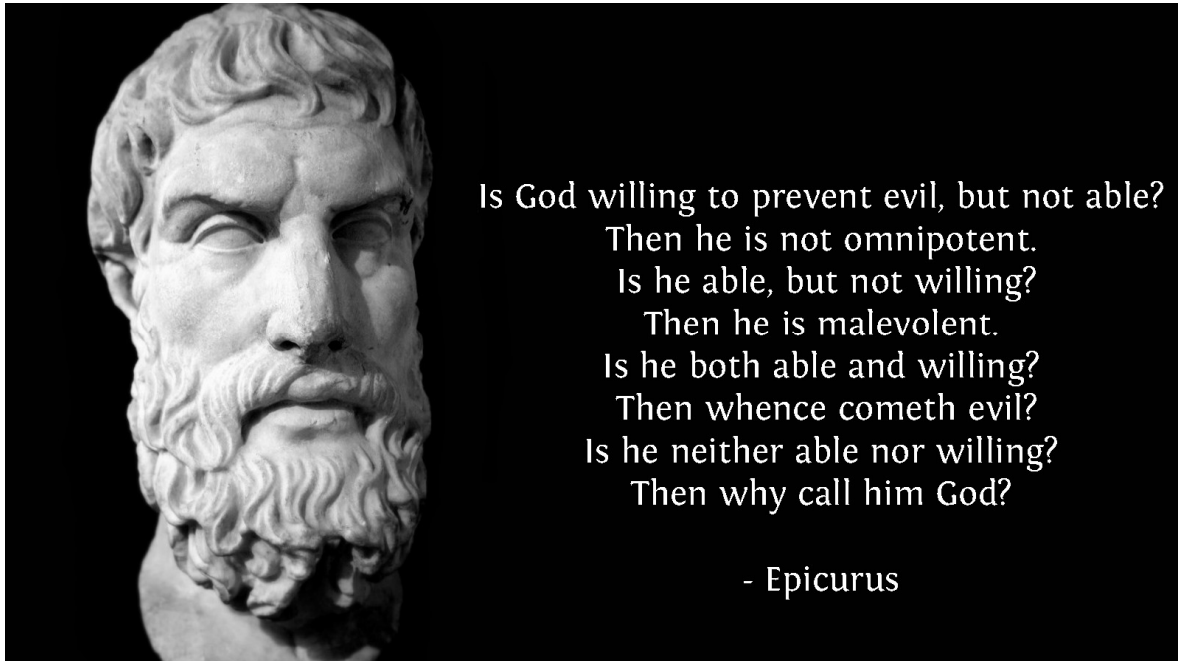

Religion and/or " war between religions " mostly to decide whose God is better; have killed millions. Instead of fighting and killing; to decide which custom to follow; how to dress; what rituals to do on a daily basis; better to spend time experimenting and developing new things, new technologies, new ideas. Scientists ( **the men** ) are busy; and **always will be busy!** **Rather, in war; with new frontiers of knowledge;** not in arguments, verbal wars, or physical wars. **Atheism is the most peaceful Doctrine.**

"**Bertrand Arthur William Russell**" the famous Philosopher, Mathematician, Logician, received 1950 Nobel Prize for Literature.

Gravitation by Prof. Subhashish Chattopadhyay SKMClasses Bangalore Useful for IIT-JEE, CBSE, I.Sc. PU-II, Boards, CET, CEE, PET, IGCSE IB AP-Physics and other exams

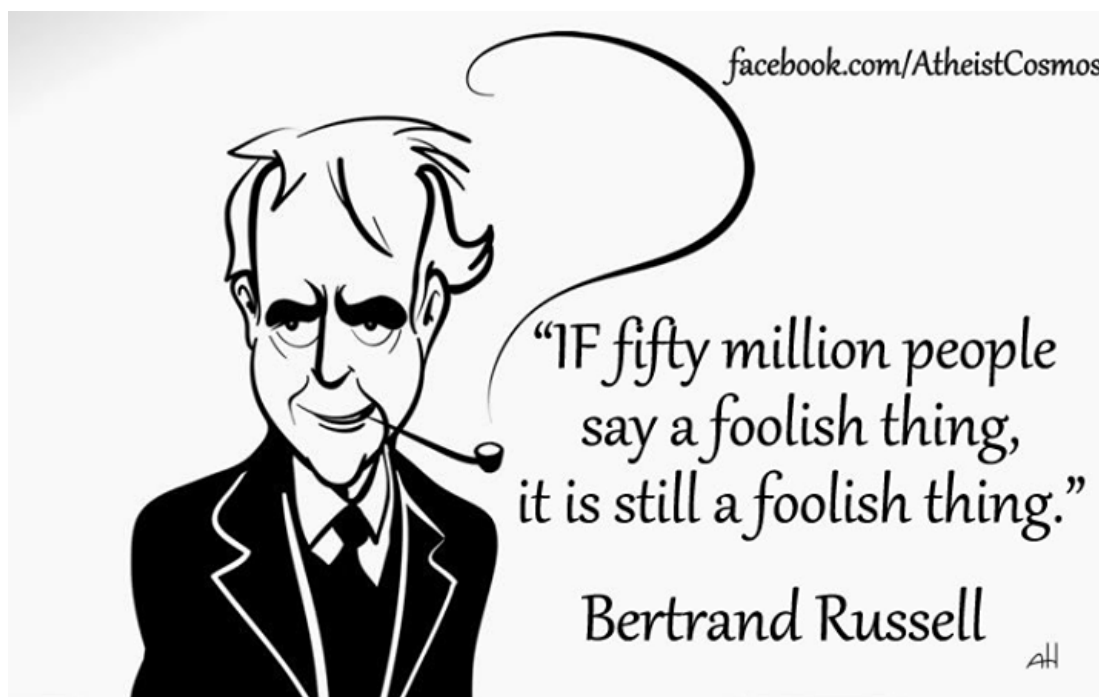

So those who want to learn can continue learning ...

See [https://www.youtube.com/results?search\\_query=History+of+science](https://www.youtube.com/results?search_query=History+of+science)

See

[https://www.youtube.com/results?search\\_query=history+of+science+the+complete+full+documentary+](https://www.youtube.com/results?search_query=history+of+science+the+complete+full+documentary+)

I will choose only two extreme examples of what Human beings have " seen " by now ...

**For far and big** ) Very powerful cameras ready with video recording facilities were scanning the sky. Coincidentally the "place or region " a camera was looking had an event ( many million years back though ) of a black hole devouring a star.

<https://www.youtube.com/watch?v=O3Z5AS3TTS4>

<https://www.youtube.com/watch?v=x7ZX10UbMus>

**For small** ) Photographs of molecules and subsequently atoms

<https://www.youtube.com/watch?v=yqLlglaz1L0>

<https://www.youtube.com/watch?v=ofp-OHlq6Wo>

<https://www.youtube.com/watch?v=oSCX78-8-q0>

<https://www.youtube.com/watch?v=RTLeWlqynW4>



Gravitation by Prof. Subhashish Chattopadhyay SKMClasses Bangalore Useful for IIT-JEE, CBSE, I.Sc. PU-II, Boards, CET, CEE, PET, IGCSE IB AP-Physics and other exams

<https://www.youtube.com/watch?v=J3xLuZnKhIY>

<https://www.youtube.com/watch?v=SMgi2j9Ks9k>

[https://www.youtube.com/watch?v=V0KjXsGRvoA&list=PLC3E0tG-9im\\_kuMwYIM7-NZR62VyWZ6rl](https://www.youtube.com/watch?v=V0KjXsGRvoA&list=PLC3E0tG-9im_kuMwYIM7-NZR62VyWZ6rl)

-

Entertainment and relaxed mind is required. Students can improve Visual Presentation skills by watching "Two men and wardrobe" by Roman Polanski

<https://www.youtube.com/watch?v=Cs2RZewMuAg>

Imagine a world where Millions of People have "**better**" Visual story telling or Visual presentation skills than **Roman Polanski** or say **Jim Jarmusch** ...

<https://www.youtube.com/watch?v=wJS2mC-7LSM>

Enjoy

-

### **Spoon Feeding Series - Gravitation**

History of Gravitation

<http://www.timaras.com/science/gravity.html>

<http://www-history.mcs.st-and.ac.uk/HistTopics/Gravitation.html>

<http://web.stanford.edu/~buzzt/gravity.html>

<http://theconversation.com/timeline-the-history-of-gravity-54528>

<https://en.wikipedia.org/wiki/Gravity>

[https://en.wikipedia.org/wiki/History\\_of\\_gravitational\\_theory](https://en.wikipedia.org/wiki/History_of_gravitational_theory)

Pradeep Kshetrapal Sir's Videos

[https://www.youtube.com/watch?v=O2aIGEMM37k&list=PLJZk2\\_\\_oyAlg0YxMYyp9ioOar-JJUr-wO](https://www.youtube.com/watch?v=O2aIGEMM37k&list=PLJZk2__oyAlg0YxMYyp9ioOar-JJUr-wO)

Gravitation by Prof. Subhashish Chattopadhyay SKMClasses Bangalore Useful for IIT-JEE, CBSE, I.Sc. PU-II, Boards, CET, CEE, PET, IGCSE IB AP-Physics and other exams

Gravitation by Prof. Subhashish Chattopadhyay SKMClasses Bangalore Useful for IIT-JEE, CBSE, I.Sc. PU-II, Boards, CET, CEE, PET, IGCSE IB AP-Physics and other exams

Classroom Videos of Subhashish Sir

Acceleration due to Gravity at a Height and Depth

<https://archive.org/details/3AccelerationGravitySurfaceHeightDepthIITJEEPhy>

Rare Videos comparing Gravity and Electrostatics

<https://archive.org/details/3GravitationElectrostaticsBasicsIITJEEPhy>

Geostationary Satellite Orbit

<https://archive.org/details/4GeostationarySatelliteOrbitRadiusIITJEEPhy12>

Gravitational Attraction due to infinite wire

<https://archive.org/details/4GravitationalAttractionDueToInfiniteWireIITJEEPhy>

Rare Videos comparing Electric Field and Gravitational Field

<https://archive.org/details/4GravitationElectrostaticsContrastIITJEEPhy>

Kepler's Law  $T^2$  square by  $R^3$  Cube is constant

<https://archive.org/details/4KeplersLawTSquareByRCubeconstIITJEEPhy>

How high will a mass go if fired at 5km/hr ?

<https://archive.org/details/4MassFiredAt5KmPerSecHowHighWillGoGravitationIITJEEPhy>

Angular Momentum of a planet in elliptical Orbit

<https://archive.org/details/5AngularMomentumOfPlanetInEllipticalOrbit>

Escape Velocity

<https://archive.org/details/5GravitationEscapeVelocityPotentialEnergyIITJEEPhy>

Rotation around Center of Mass comparable Masses Elliptical orbits

<https://archive.org/details/5RotationAroundCMComparableMassesEllipseIITJEEPhy>

Gravitational Field due to a shell

<https://archive.org/details/6GravitationalFieldDueToShellIITJEEPhy>

If Radius of a planet shrinks by 1%

<https://archive.org/details/7IITJEE198183RadiusOfAPlanetShrinksBy1GainInPEWhenRaisedHR>

Gravitation by Prof. Subhashish Chattopadhyay SKMClasses Bangalore Useful for IIT-JEE, CBSE, I.Sc. PU-II, Boards, CET, CEE, PET, IGCSE IB AP-Physics and other exams

Gravitation by Prof. Subhashish Chattopadhyay SKMClasses Bangalore Useful for IIT-JEE, CBSE, I.Sc. PU-II, Boards, CET, CEE, PET, IGCSE IB AP-Physics and other exams

Gain in Gravitational Potential Energy when  $h = R$

<https://archive.org/details/7IITJEE1983GainInGravitationalPotentialEnergyWhenHRBasics>

At what speed the satellite crashes if moving at  $V_e / 2$  ( half of escape velocity )

<https://archive.org/details/7IITJEE1990FindHIfSatelliteMovingAtVeBy2AtWhatSpeedCrashesOnEarthIfStopped>

Roorkey-1988-How-much-more-speed-needed-to-escape-when-a-planet-is-rotating-at- $h=R$

<https://archive.org/details/7Roorkey1988HowMuchMoreSpeedNeededToEscapeWhenAPlanetIsRotatingAtHR>

Three IIT JEE Problems

<https://archive.org/details/9IITJEE1989GravitationalAttractionWithSpecialRelationshipVeryImportantProblemAssumptions>

Two AIEEE ( IIT JEE main ) problems

<https://archive.org/details/AIEEE2002GravitationASatelliteHasToBeMovedFrom2Rto3R>

Four Problems in Gravity asked in various exams ( AMU, Kerala PMT etc )

<https://archive.org/details/KeralaPMT2004GravitationProblemComparePlanetsTSquareByRcubelsConstant2>

:-{D

Gravitation by Prof. Subhashish Chattopadhyay SKMClasses Bangalore Useful for IIT-JEE, CBSE, I.Sc. PU-II, Boards, CET, CEE, PET, IGCSE IB AP-Physics and other exams

### To recall standard integrals

$f(x)$	$\int f(x)dx$	$f(x)$	$\int f(x)dx$
$x^n$	$\frac{x^{n+1}}{n+1} \quad (n \neq -1)$	$[g(x)]^n g'(x)$	$\frac{[g(x)]^{n+1}}{n+1} \quad (n \neq -1)$
$\frac{1}{x}$	$\ln x $	$\frac{g'(x)}{g(x)}$	$\ln g(x) $
$e^x$	$e^x$	$a^x$	$\frac{a^x}{\ln a} \quad (a > 0)$
$\sin x$	$-\cos x$	$\sinh x$	$\cosh x$
$\cos x$	$\sin x$	$\cosh x$	$\sinh x$
$\tan x$	$-\ln \cos x $	$\tanh x$	$\ln \cosh x$
$\operatorname{cosec} x$	$\ln \tan \frac{x}{2} $	$\operatorname{cosech} x$	$\ln \tanh \frac{x}{2} $
$\sec x$	$\ln \sec x + \tan x $	$\operatorname{sech} x$	$2 \tan^{-1} e^x$
$\sec^2 x$	$\tan x$	$\operatorname{sech}^2 x$	$\tanh x$
$\cot x$	$\ln \sin x $	$\operatorname{coth} x$	$\ln \sinh x $
$\sin^2 x$	$\frac{x}{2} - \frac{\sin 2x}{4}$	$\sinh^2 x$	$\frac{\sinh 2x}{4} - \frac{x}{2}$
$\cos^2 x$	$\frac{x}{2} + \frac{\sin 2x}{4}$	$\cosh^2 x$	$\frac{\sinh 2x}{4} + \frac{x}{2}$

$f(x)$	$\int f(x) dx$	$f(x)$	$\int f(x) dx$
$\frac{1}{a^2+x^2}$	$\frac{1}{a} \tan^{-1} \frac{x}{a}$ $(a > 0)$	$\frac{1}{a^2-x^2}$	$\frac{1}{2a} \ln \left  \frac{a+x}{a-x} \right  \quad (0 <  x  < a)$ $\frac{1}{2a} \ln \left  \frac{x-a}{x+a} \right  \quad ( x  > a > 0)$
$\frac{1}{\sqrt{a^2-x^2}}$	$\sin^{-1} \frac{x}{a}$ $(-a < x < a)$	$\frac{1}{\sqrt{a^2+x^2}}$	$\ln \left  \frac{x+\sqrt{a^2+x^2}}{a} \right  \quad (a > 0)$ $\ln \left  \frac{x+\sqrt{x^2-a^2}}{a} \right  \quad (x > a > 0)$
$\sqrt{a^2-x^2}$	$\frac{a^2}{2} \left[ \sin^{-1} \left( \frac{x}{a} \right) + \frac{x\sqrt{a^2-x^2}}{a^2} \right]$	$\sqrt{a^2+x^2}$	$\frac{a^2}{2} \left[ \sinh^{-1} \left( \frac{x}{a} \right) + \frac{x\sqrt{a^2+x^2}}{a^2} \right]$ $\frac{a^2}{2} \left[ -\cosh^{-1} \left( \frac{x}{a} \right) + \frac{x\sqrt{x^2-a^2}}{a^2} \right]$

Some series Expansions -

Gravitation by Prof. Subhashish Chattopadhyay SKMClasses Bangalore Useful for IIT-JEE, CBSE, I.Sc. PU-II, Boards, CET, CEE, PET, IGCSE IB AP-Physics and other exams

$$\frac{\pi}{2} = \left(\frac{2}{1} \frac{2}{3}\right) \left(\frac{4}{3} \frac{4}{5}\right) \left(\frac{6}{5} \frac{6}{7}\right) \left(\frac{8}{7} \frac{8}{9}\right) \dots$$

$$\pi = \frac{4}{1} - \frac{4}{3} + \frac{4}{5} - \frac{4}{7} + \frac{4}{9} - \frac{4}{11} + \frac{4}{13} - \dots$$

$$\frac{\pi}{4} = \frac{1}{1} - \frac{1}{3} + \frac{1}{5} - \frac{1}{7} + \frac{1}{9} - \dots$$

$$\pi = \sqrt{12} \left(1 - \frac{1}{3 \cdot 3} + \frac{1}{5 \cdot 3^2} - \frac{1}{7 \cdot 3^3} + \dots\right)$$

$$\frac{\pi^2}{6} = \frac{1}{1^2} + \frac{1}{2^2} + \frac{1}{3^2} + \frac{1}{4^2} + \dots = \sum_{n=1}^{\infty} \frac{1}{n^2}$$

$$\int_0^{\pi/2} \log \sin x \, dx = -\frac{\pi}{2} \log 2 = \frac{\pi}{2} \log \frac{1}{2}$$

Solve a series problem

If  $\frac{1}{1^2} + \frac{1}{2^2} + \frac{1}{3^2} + \dots$  upto  $\infty = \frac{\pi^2}{6}$ , then value of

$\frac{1}{1^2} + \frac{1}{3^2} + \frac{1}{5^2} + \dots$  up to  $\infty$  is

- (a)  $\frac{\pi^2}{4}$       (b)  $\frac{\pi^2}{6}$       (c)  $\frac{\pi^2}{8}$       (d)  $\frac{\pi^2}{12}$

Ans. (c)

**Solution** We have  $\frac{1}{1^2} + \frac{1}{3^2} + \frac{1}{5^2} + \dots$  upto  $\infty$

$$= \frac{1}{1^2} + \frac{1}{2^2} + \frac{1}{3^2} + \frac{1}{4^2} + \frac{1}{5^2} + \frac{1}{6^2} \dots \text{ upto } \infty$$

$$- \frac{1}{2^2} \left[1 + \frac{1}{2^2} + \frac{1}{3^2} + \dots\right]$$

$$= \frac{\pi^2}{6} - \frac{1}{4} \left(\frac{\pi^2}{6}\right) = \frac{\pi^2}{8}$$

$$1 - \frac{1}{2^2} + \frac{1}{3^2} - \frac{1}{4^2} + \frac{1}{5^2} - \frac{1}{6^2} + \dots \infty = \frac{\pi^2}{12}$$

$$\frac{1}{2^2} + \frac{1}{4^2} + \frac{1}{6^2} + \dots \infty = \frac{\pi^2}{24}$$

Gravitation by Prof. Subhashish Chattopadhyay SKMClasses Bangalore Useful for IIT-JEE, CBSE, I.Sc. PU-II, Boards, CET, CEE, PET, IGCSE IB AP-Physics and other exams

Gravitation by Prof. Subhashish Chattopadhyay SKMClasses Bangalore Useful for IIT-JEE, CBSE, I.Sc. PU-II, Boards, CET, CEE, PET, IGCSE IB AP-Physics and other exams

$$\frac{\sin \sqrt{x}}{\sqrt{x}} = 1 - \frac{x}{3!} + \frac{x^2}{5!} - \frac{x^3}{7!} + \frac{x^4}{9!} - \frac{x^5}{11!} + \dots$$

$$\cos x = 1 - \frac{x^2}{2!} + \frac{x^4}{4!} - \dots = \sum_{k=0}^n \frac{(-1)^k x^{2k}}{(2k)!}$$

$$\sin x = x - \frac{x^3}{3!} + \frac{x^5}{5!} - \dots = \sum_{k=0}^n \frac{(-1)^k x^{2k+1}}{(2k+1)!}$$

$$\cosh x = 1 + \frac{x^2}{2!} + \frac{x^4}{4!} + \dots = \sum_{k=0}^n \frac{x^{2k}}{(2k)!}$$

$$\sinh x = x + \frac{x^3}{3!} + \frac{x^5}{5!} + \dots = \sum_{k=0}^n \frac{x^{2k+1}}{(2k+1)!}$$

$$\tan^{-1} x = x - \frac{x^3}{3} + \frac{x^5}{5} - \frac{x^7}{7} + \dots \quad (-1 \leq x < 1)$$

$$\tan x = x + \frac{x^3}{3} + \frac{2x^5}{15} + \frac{17x^7}{315} + \frac{62x^9}{2835} + \dots + \frac{2^{2n} (2^{2n} - 1) B_n x^{2n-1}}{(2n)!} + \dots \quad |x| < \frac{\pi}{2}$$

$$\sec x = 1 + \frac{x^2}{2} + \frac{5x^4}{24} + \frac{61x^6}{720} + \dots + \frac{E_n x^{2n}}{(2n)!} + \dots \quad |x| < \frac{\pi}{2}$$

$$\csc x = \frac{1}{x} + \frac{x}{6} + \frac{7x^3}{360} + \frac{31x^5}{15120} + \dots + \frac{2(2^{2n-1} - 1) B_n x^{2n-1}}{(2n)!} + \dots \quad 0 < |x| < \pi$$

$$\cot x = \frac{1}{x} - \frac{x}{3} + \frac{x^3}{45} - \frac{2x^5}{945} - \dots - \frac{2^{2n} B_n x^{2n-1}}{(2n)!} - \dots \quad 0 < |x| < \pi$$

Gravitation by Prof. Subhashish Chattopadhyay SKMClasses Bangalore Useful for IIT-JEE, CBSE, I.Sc. PU-II, Boards, CET, CEE, PET, IGCSE IB AP-Physics and other exams

$$\tan x = x + \frac{x^3}{3} + \frac{2x^5}{15} + \dots$$

$$\sec x = 1 + \frac{x^2}{2} + \frac{5x^4}{4} + \dots$$

$$\log(\cos x) = -\frac{x^2}{2} - \frac{2x^4}{4} - \dots$$

$$\log(1 + \sin x) = x - \frac{x^2}{2} + \frac{x^3}{6} - \frac{x^4}{12} + \dots$$

$$\sin^{-1} x = x + \frac{1}{2} \frac{x^3}{3} + \frac{1 \cdot 3}{2 \cdot 4} \frac{x^5}{5} + \frac{1 \cdot 3 \cdot 5}{2 \cdot 4 \cdot 6} \frac{x^7}{7} + \dots \quad |x| < 1$$

$$\cos^{-1} x = \frac{\pi}{2} - \sin^{-1} x$$

$$= \frac{\pi}{2} - \left( x + \frac{1}{2} \frac{x^3}{3} + \frac{1 \cdot 3}{2 \cdot 4} \frac{x^5}{5} + \frac{1 \cdot 3 \cdot 5}{2 \cdot 4 \cdot 6} \frac{x^7}{7} + \dots \right) \quad |x| < 1$$

$$\tan^{-1} x = \begin{cases} x - \frac{x^3}{3} + \frac{x^5}{5} - \frac{x^7}{7} + \dots & |x| < 1 \\ \pm \frac{\pi}{2} - \frac{1}{x} + \frac{1}{3x^3} - \frac{1}{5x^5} + \dots & \begin{cases} + \text{ if } x \geq 1 \\ - \text{ if } x \leq -1 \end{cases} \end{cases}$$

$$\sec^{-1} x = \cos^{-1} \left( \frac{1}{x} \right)$$

$$= \frac{\pi}{2} - \left( \frac{1}{x} + \frac{1}{2 \cdot 3x^3} + \frac{1 \cdot 3}{2 \cdot 4 \cdot 5x^5} + \frac{1 \cdot 3 \cdot 5}{2 \cdot 4 \cdot 6 \cdot 7x^7} + \dots \right) \quad |x| > 1$$

$$\csc^{-1} x = \sin^{-1}(1/x)$$

$$= \frac{1}{x} + \frac{1}{2 \cdot 3x^3} + \frac{1 \cdot 3}{2 \cdot 4 \cdot 5x^5} + \frac{1 \cdot 3 \cdot 5}{2 \cdot 4 \cdot 6 \cdot 7x^7} + \dots \quad |x| > 1$$

$$\cot^{-1} x = \frac{\pi}{2} - \tan^{-1} x$$

$$= \begin{cases} \frac{\pi}{2} - \left( x - \frac{x^3}{3} + \frac{x^5}{5} - \frac{x^7}{7} + \dots \right) & |x| < 1 \end{cases}$$

$$\begin{cases} p\pi + \frac{1}{x} - \frac{1}{3x^3} + \frac{1}{5x^5} + \dots & \begin{cases} p = 0 \text{ if } x \geq 1 \\ p = 1 \text{ if } x \leq -1 \end{cases} \end{cases}$$

$$e^x = 1 + \frac{x}{1!} + \frac{x^2}{2!} + \frac{x^3}{3!} + \dots = \sum_{n=0}^{\infty} \frac{x^n}{n!}$$

$$\ln x = 2 \left[ \frac{x-1}{x+1} + \frac{1}{3} \left( \frac{x-1}{x+1} \right)^3 + \frac{1}{5} \left( \frac{x-1}{x+1} \right)^5 + \dots \right]$$

$$= 2 \sum_{n=1}^{\infty} \frac{1}{2n-1} \left( \frac{x-1}{x+1} \right)^{2n-1} \quad (x > 0)$$

$$\ln x = \frac{x-1}{x} + \frac{1}{2} \left( \frac{x-1}{x} \right)^2 + \frac{1}{3} \left( \frac{x-1}{x} \right)^3 + \dots$$

$$= \sum_{n=1}^{\infty} \frac{1}{n} \left( \frac{x-1}{x} \right)^n \quad (x > \frac{1}{2})$$

$$\ln x = (x-1) - \frac{1}{2}(x-1)^2 + \frac{1}{3}(x-1)^3 - \dots$$

$$= \sum_{n=1}^{\infty} (-1)^{n-1} \frac{1}{n} (x-1)^n \quad (0 < x \leq 2)$$

$$\ln(1+x) = x - \frac{1}{2}x^2 + \frac{1}{3}x^3 - \dots$$

$$= \sum_{n=1}^{\infty} (-1)^{n-1} \frac{1}{n} x^n \quad (|x| < 1)$$

$$\log_e(1-x) = -x - \frac{x^2}{2} - \frac{x^3}{3} - \frac{x^4}{4} - \dots \infty \quad (-1 \leq x < 1)$$

$$\log_e(1+x) - \log_e(1-x) =$$

$$\log_e \frac{1+x}{1-x} = 2 \left( x + \frac{x^3}{3} + \frac{x^5}{5} + \dots \infty \right) \quad (-1 < x < 1)$$

$$\log_e \left( 1 + \frac{1}{n} \right) = \log_e \frac{n+1}{n} = 2 \left[ \frac{1}{2n+1} + \frac{1}{3(2n+1)^3} + \frac{1}{5(2n+1)^5} + \dots \infty \right]$$

$$\log_e(1+x) + \log_e(1-x) = \log_e(1-x^2) = -2 \left( \frac{x^2}{2} + \frac{x^4}{4} + \dots \infty \right) \quad (-1 < x < 1)$$

$$\log 2 = 1 - \frac{1}{2} + \frac{1}{3} - \frac{1}{4} + \frac{1}{5} - \dots = \frac{1}{1.2} + \frac{1}{3.4} + \frac{1}{5.6} + \dots$$



## Important Results

$$(i) (a) \int_0^{\pi/2} \frac{\sin^n x}{\sin^n x + \cos^n x} dx = \frac{\pi}{4} = \int_0^{\pi/2} \frac{\cos^n x}{\sin^n x + \cos^n x} dx$$

$$(b) \int_0^{\pi/2} \frac{\tan^n x}{1 + \tan^n x} dx = \frac{\pi}{4} = \int_0^{\pi/2} \frac{dx}{1 + \tan^n x}$$

$$(c) \int_0^{\pi/2} \frac{dx}{1 + \cot^n x} = \frac{\pi}{4} = \int_0^{\pi/2} \frac{\cot^n x}{1 + \cot^n x} dx$$

$$(d) \int_0^{\pi/2} \frac{\tan^n x}{\tan^n x + \cot^n x} dx = \frac{\pi}{4} = \int_0^{\pi/2} \frac{\cot^n x}{\tan^n x + \cot^n x} dx$$

$$(e) \int_0^{\pi/2} \frac{\sec^n x}{\sec^n x + \operatorname{cosec}^n x} dx = \frac{\pi}{4} = \int_0^{\pi/2} \frac{\operatorname{cosec}^n x}{\sec^n x + \operatorname{cosec}^n x} dx \text{ where, } n \in R$$

$$(ii) \int_0^{\pi/2} \frac{a^{\sin^n x}}{a^{\sin^n x} + a^{\cos^n x}} dx = \int_0^{\pi/2} \frac{a^{\cos^n x}}{a^{\sin^n x} + a^{\cos^n x}} dx = \frac{\pi}{4}$$

$$(iii) (a) \int_0^{\pi/2} \log \sin x dx = \int_0^{\pi/2} \log \cos x dx = -\frac{\pi}{2} \log 2$$

$$(b) \int_0^{\pi/2} \log \tan x dx = \int_0^{\pi/2} \log \cot x dx = 0$$

$$(c) \int_0^{\pi/2} \log \sec x dx = \int_0^{\pi/2} \log \operatorname{cosec} x dx = \frac{\pi}{2} \log 2$$

$$(iv) (a) \int_0^{\infty} e^{-ax} \sin bx dx = \frac{b}{a^2 + b^2}$$

$$(b) \int_0^{\infty} e^{-ax} \cos bx dx = \frac{a}{a^2 + b^2}$$

$$(c) \int_0^{\infty} e^{-ax} x^n dx = \frac{n!}{a^{n+1}}$$

Gravitation by Prof. Subhashish Chattopadhyay SKMClasses Bangalore Useful for IIT-JEE, CBSE, I.Sc. PU-II, Boards, CET, CEE, PET, IGCSE IB AP-Physics and other exams

$$\int \frac{dx}{\sqrt{x^2 - a^2}} = \ln(x + \sqrt{x^2 - a^2}) + C$$

$$\int \frac{dx}{\sqrt{x^2 + a^2}} = \ln(x + \sqrt{x^2 + a^2}) + C$$

$$\int \frac{dx}{x^2 - a^2} = \frac{1}{2a} \ln\left(\frac{x-a}{x+a}\right) + C$$

$$\int \frac{dx}{a^2 - x^2} = \frac{1}{2a} \ln\left(\frac{a+x}{a-x}\right) + C$$

$$\int \sqrt{a^2 - x^2} dx = \frac{x}{2} \sqrt{a^2 - x^2} + \frac{a^2}{2} \sin^{-1}\left(\frac{x}{a}\right) + C$$

$$\int \sqrt{a^2 + x^2} dx = \frac{x}{2} \sqrt{a^2 + x^2} + \frac{a^2}{2} \sinh^{-1}\left(\frac{x}{a}\right) + C$$

$$\int \sqrt{x^2 - a^2} dx = \frac{x}{2} \sqrt{x^2 - a^2} - \frac{a^2}{2} \cosh^{-1}\left(\frac{x}{a}\right) + C$$

Plato and many others, since long told something about Truth ...

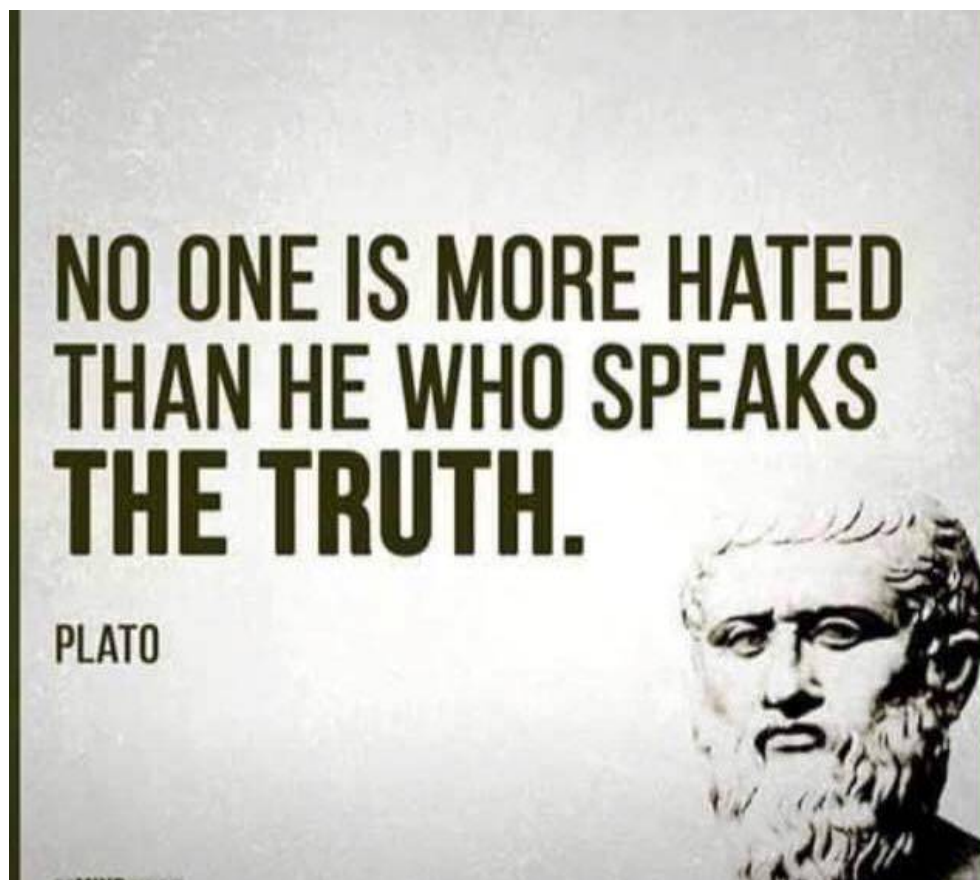

So I "lied" on a few things in this Book ! :-{D

Gravitation by Prof. Subhashish Chattopadhyay SKMClasses Bangalore Useful for IIT-JEE, CBSE, I.Sc. PU-II, Boards, CET, CEE, PET, IGCSE IB AP-Physics and other exams

Gravitation by Prof. Subhashish Chattopadhyay SKMClasses Bangalore Useful for IIT-JEE, CBSE, I.Sc. PU-II, Boards, CET, CEE, PET, IGCSE IB AP-Physics and other exams



( In 2016 Celebrating 27 years of Excellence in Teaching )

Good Luck to you for your Preparations, References, and Exams

All Other Books written by me can be downloaded from

<https://zookeepersblog.wordpress.com/free-pdf-e-book-download-for-iit-jee-cbse-isc-cet-physics-chemistry-maths-from-professor-subhashish-skmclasses/>

Professor [Subhashish Chattopadhyay](#)

[Learn more](#) at <http://skmclasses.weebly.com/iit-jee-home-tuitions-bangalore.html>

[Twitter](#) - <https://twitter.com/ZookeeperPhy>

[Facebook](#) - <https://www.facebook.com/IIT.JEE.by.Prof.Subhashish/>

[Blog](#) - <http://skmclasses.kinja.com>

Gravitation by Prof. Subhashish Chattopadhyay SKMClasses Bangalore Useful for IIT-JEE, CBSE, I.Sc. PU-II, Boards, CET, CEE, PET, IGCSE IB AP-Physics and other exams